

11301 and 11302 Programmable Oscilloscopes

User's Reference Manual

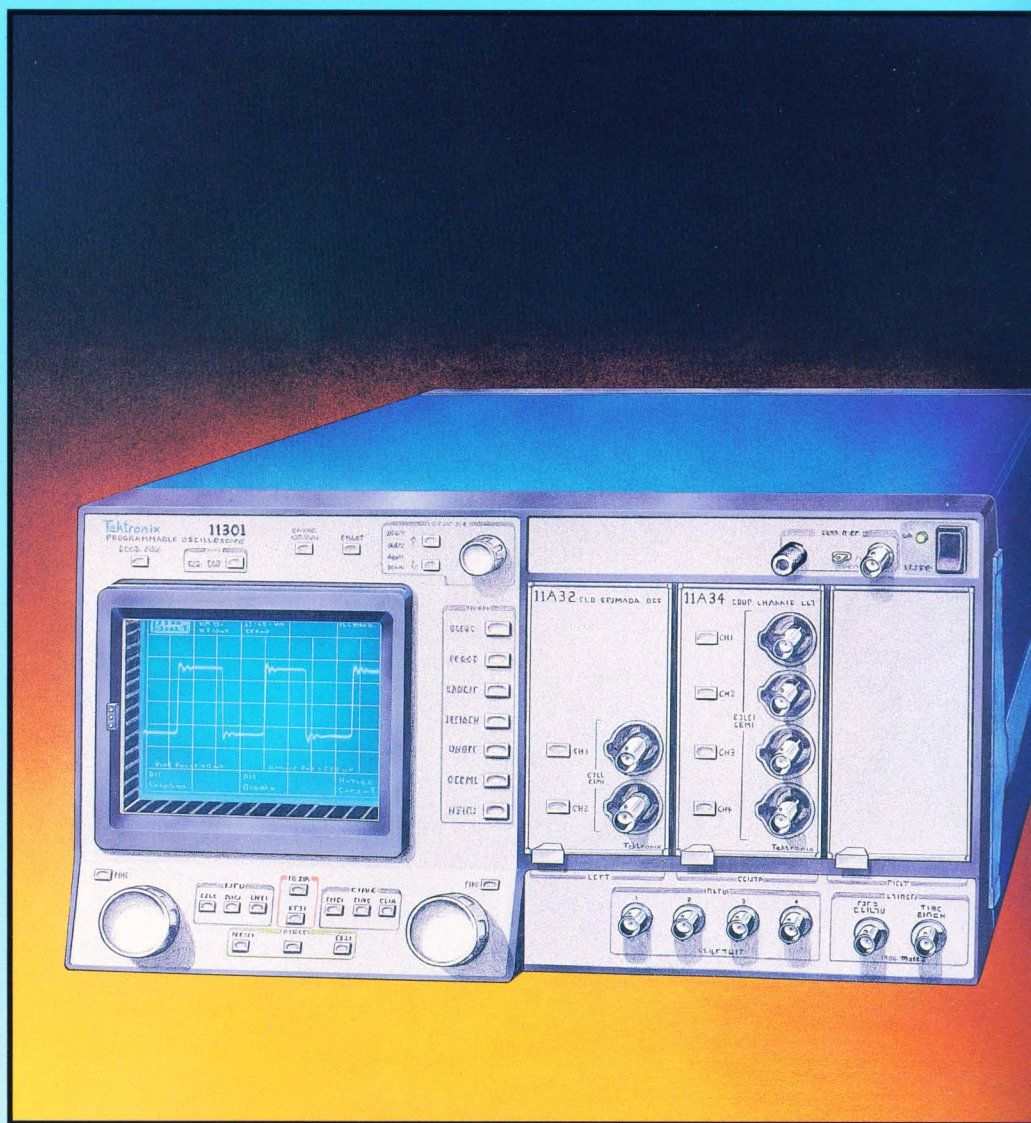

manual produced by

ElectronicsAndBooks@Yahoo.com

PO Box 5156

2000 GD Haarlem

Netherlands

manual produced by

ElectronicsAndBooks@Yahoo.com

PO Box 5156

2000 GD Haarlem

Netherlands

11301 and 11302

Programmable Oscilloscopes

User's Reference Manual

INSTRUMENT SERIAL NUMBERS

Each instrument has a serial number on a panel insert, tag, or stamped on the chassis. The first number or letter designates the country of manufacture. The last five digits of the serial number are assigned sequentially and are unique to each instrument. Those manufactured in the United States have six unique digits. The country of manufacture is identified as follows:

B000000	Tektronix, Inc. Beaverton, Oregon, USA
100000	Tektronix Guernsey, Ltd., Channel Islands
200000	Tektronix United Kingdom, Ltd., London
300000	Sony/Tektronix, Japan
700000	Tektronix Holland, NV, Heerenveen, The Netherlands

Copyright © Tektronix, Inc., 1986. All rights reserved. Tektronix products are covered by U.S. and foreign patents, issued and pending. TEKTRONIX, INC., SCOPEMOBILE and  are registered trademarks. Printed in U.S.A.

IBM® is a registered trademark of International Business Machines Corporation.
GPIB-PC is a trademark of National Instruments Corporation.
Centronics® is a registered trademark of Data Computer Corporation.

Key to Manuals

OPERATING MANUALS

THESE DOCUMENTS ARE PROVIDED WITH THE INSTRUMENT AS A STANDARD ACCESSORY. REFER TO APPENDIX B, ACCESSORY LIST.

A QUICK RECALL OF OPERATIONS DISCUSSED IN THE USER'S REFERENCE MANUAL



070-6105-00

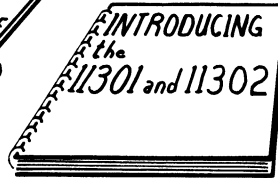

070-6104-00

EXPLAINS OPERATING CONCEPTS

ALPHABETICALLY ORGANIZED DETAILED OPERATING INSTRUCTIONS

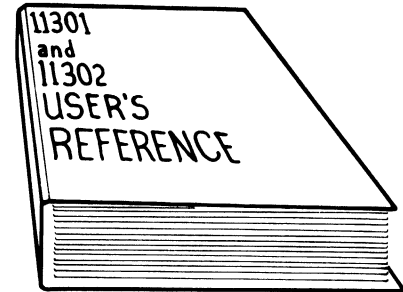

070-6106-00

SERVICE MANUALS

THE FOLLOWING SERVICE DOCUMENTS ARE AVAILABLE AS AN OPTIONAL ACCESSORY. REFER TO APPENDIX B, ACCESSORY LIST, FOR FURTHER INFORMATION.

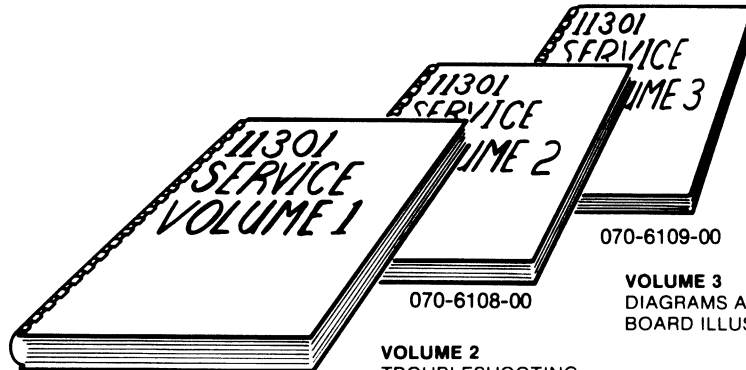

070-6107-00

070-6108-00

070-6109-00

VOLUME 2
TROUBLESHOOTING AND DIAGNOSTICS

VOLUME 3
DIAGRAMS AND CIRCUIT BOARD ILLUSTRATIONS

VOLUME 1
GENERAL INFORMATION, THEORY OF OPERATION, CHECKS AND ADJUSTMENTS, AND MAINTENANCE

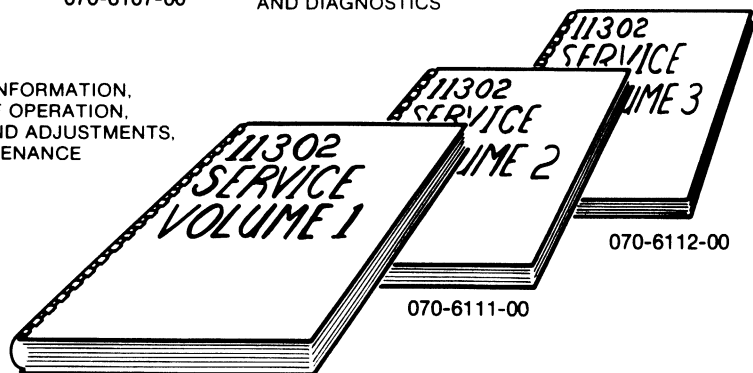

070-6110-00

070-6111-00

070-6112-00

6106-001

How to Use This Manual

The Table of Contents lists all headings to the third order head; that is, to the third level of importance. Each first order head is listed in order of use. The headings thereafter are listed alphabetically. This is done to facilitate finding material once you are in the midst of the text. For instance, if you were in Section 2, Operating Information, and in the "Waveform Acquisition" subsection reading Vertical Menu information, you would know that material relating to the Horizontal Menu is more towards the front of the manual. Horizontal comes alphabetically before Vertical.

To help you quickly retrieve information, bleed-tabs separate all information pertaining to a first order head. At the beginning of each new bleed-tab position is a brief contents of that subsection.

Some sections, like Section 4 where logical order of use isn't a primary concern, are alphabetized in their entirety. Section 3, "GPIB and RS-232-C Interfaces" has only the command set alphabetized.

Reference Aids

To quickly locate information, use the following reference aids:

- The Table of Contents at the beginning of this manual lists subjects covered in the six sections and two appendixes.
- The Table of Contents at the beginning of each section lists the subjects in more detail than covered in the main Table of Contents at the front of the manual.
- The Index is a quick way to find information when you don't know which section discusses it. All screen-displayed nomenclature can be identified by its medium or bold print.
- "Errors, Warnings, and Messages" explain meanings of various messages displayed on the screen and where to find more specific detail.
- Appendixes provide summaries of useful information, as follows:

Appendix A—Glossary
Appendix B—Accessory List

Instrument Documentation

Three documents provide operating information about the 11301 and the 11302 Programmable Oscilloscopes.

- The 11301 and 11302 Programmable Oscilloscopes Pocket Reference is designed to give you quick recall of operation and syntax of functions you already know.
- Introducing the 11301 and 11302 Programmable Oscilloscopes presents the concepts and methods of operating the instrument. As a training aid, this manual helps a new user easily learn the conventions and concepts of the oscilloscope and its operation.
- The 11301 and 11302 Programmable Oscilloscopes User's Reference manual is the reference document for the user-operator. This manual contains installation, a procedure for incoming inspection, measurement instructions, interface commands, instrument specifications, and a list of instrument options.

Contents

Key to Manuals.....	i
How to Use This Manual.....	ii
Contents.....	iii
Illustrations.....	x
Tables.....	xiv
Operators Safety Summary.....	xvi
Introduction.....	xviii
Oscilloscope System Architecture.....	xix
Measured Signals.....	xix
Triggering.....	xxi
Counter View Display.....	xxi
Measurement Interval.....	xxi
Display Paths.....	xxii

Installation

Operating Power Information.....	1-2
Operating Environment.....	1-5
Plug-In Unit Operating Information.....	1-6
External Interface Connection.....	1-8
Packaging for Shipment.....	1-8
Rackmounting.....	1-9
Incoming Inspection and Performance Verification.....	1-10

Operating Information

Oscilloscope Familiarization.....	2-1
Front-Panel Descriptions.....	2-3
Rear-Panel Descriptions.....	2-5
Buttons, Controls, Connectors, and Indicators.....	2-6
Buttons and Indicators Above The Display.....	2-6
Calibrator Connections.....	2-8
Crt Display Screen.....	2-9
Knobs and Control-Menu Buttons.....	2-10
Major Menu Buttons.....	2-13
Plug-In Compartments.....	2-15
Rear- and Front-Panel External Connections.....	2-15
RS232C and IEEE-488 (GPIB) Interface Connectors.....	2-19
Switches for Power (On/Standby and Principal Power Switch).....	2-20
Power-Up Information.....	2-22
Instrument Verification.....	2-22
Calibration.....	2-22
Diagnostics.....	2-25
Self-Test.....	2-25
Oscilloscope Initialization.....	2-27

Display Area	2-31
Control Menus.....	2-32
Knobs.....	2-36
Major Menus.....	2-37
Numeric Displays.....	2-37
Prompt and Message Areas.....	2-37
Touch Panel.....	2-38
Waveform Display.....	2-38
Waveform Acquisition	2-39
Acquiring Waveforms.....	2-39
Autoset.....	2-40
Beam Find.....	2-45
Delayed Windows ("Delayed Sweeps").....	2-46
Horizontal Menu.....	2-50
Input Channel Selection (Using Probe ID).....	2-57
Probe ID (Summary of Uses and Functions).....	2-60
Trace Selection.....	2-63
Vertical Menu.....	2-65
Waveform Menu.....	2-67
Triggering	2-77
Trigger Holdoff Menu.....	2-77
Trigger Level Menu.....	2-83
Trigger Source Major Menu.....	2-88
Display Control	2-97
Display Adjust Major Menu.....	2-97
Intensity.....	2-102
Measurement	2-105
Counter/Timer.....	2-105
Counter/Timer Controls and Functions.....	2-105
Counter/Timer Knob Assignments.....	2-120
Counter/Timer Operation.....	2-122
Counter View Traces.....	2-127
Presentation of Results.....	2-130
Counter/Timer Concepts.....	2-132
Description.....	2-132
Frequency Measurements.....	2-136
Input Coupling, Noise, and Attenuation.....	2-138
Nulling the Counter/Timer.....	2-140
Reducing Measurement Errors.....	2-140
Time Interval Measurements.....	2-141
Cursors.....	2-143
Cursors Menu.....	2-143
Knob Behavior.....	2-148
Restrictions.....	2-148
Measure Menu.....	2-149

Numeric Entry	2-153
Choices of Left or Right Knob.....	2-155
Count Reference.....	2-156
Functioning as a Calculator.....	2-156
Operation.....	2-156
Initial Conditions.....	2-157
Store and Recall (Instrument Settings)	2-159
Menu Behavior.....	2-159
Operation.....	2-160
Operator's Procedure.....	2-161
Utilities	2-163
Autoset.....	2-164
Beep.....	2-165
Calibration.....	2-166
Calibrator Signal (Front-Panel Output).....	2-167
Extended Test.....	2-168
GPIB (IEEE-488).....	2-169
Initialize.....	2-171
Input and Output BNC Control.....	2-172
Probe Cal.....	2-173
Probe ID.....	2-174
Probe Skew.....	2-175
RS-232-C Selections.....	2-176
Test.....	2-177
Time and Date Selections.....	2-178
Measurement Concept Tutorial	2-179
Coaxial Cables and Probes.....	2-179
Measurement Examples.....	2-180
Automatic Measurements.....	2-180
Cursors Measurements.....	2-182
Counter/Timer Measurements.....	2-192
Nulling the Counter/Timer.....	2-199
Time Interval Measurement of Propagation Delay.....	2-200

GPIB and RS-232-C Interfaces

Selecting an Interface	3-2
GPIB & RS-232 Features.....	3-2
Contrast: IEEE-488 Standard vs RS-232-C Standard.....	3-3
GPIB and RS-232-C Functional Overview.....	3-4
GPIB Interface Functions.....	3-4
GPIB Protocol.....	3-4
GPIB Messages.....	3-5
RS-232-C Functional Characteristics.....	3-7
RS-232-C Messages.....	3-8

Getting Started	3-9
Configuring Your System.....	3-9
Power Up Self-Test and SRQ.....	3-12
Setting Up The Interface.....	3-12
Command Rules and Data Transfer.....	3-15
Programming Notes.....	3-16
Sending Commands To The Oscilloscope.....	3-16
Responses From The Oscilloscope.....	3-18
Data Transfer Examples.....	3-21
Command Set	3-23
Command Usage Conventions.....	3-23
Syntax Conventions.....	3-23
Command Structures.....	3-25
Command Processing Conventions.....	3-28
ASCII Interface Operating Conventions.....	3-31
Syntax and Descriptions.....	3-38
Autoset Commands.....	3-38
AUTOSET Command.....	3-38
Channel Commands.....	3-40
CH<compartment><ui> Command.....	3-40
Counter/Timer Commands.....	3-43
CTRESET Command.....	3-44
CTMEAS Command.....	3-44
CTRESULT? Query Command.....	3-44
CTFREQUENCY, CTPERIOD, CTWIDTH, CTTOTAL, CTRATIO, and CTTIME Commands.....	3-45
CTCLOCK Command.....	3-46
Cursor Commands.....	3-48
CURSOR Command.....	3-49
VCURSOR & HCURSOR Commands.....	3-49
V1ABS & V2ABS and H1ABS & H2ABS Commands.....	3-49
V1REL & V2REL and H1REL & H2REL Commands.....	3-49
VREF? & HREF? Query Commands.....	3-50
VDELTA? & HDELTA? Query Commands.....	3-50
Data Transfer Commands.....	3-52
WFMPRE Command.....	3-52
CURVE Command.....	3-53
INPUT Command.....	3-54
OUTPUT Command.....	3-54
ENCDG Command.....	3-54
WAVFRM? Query Command.....	3-55
SET? Query Command.....	3-55
Diagnostic Commands.....	3-57
TEST Command.....	3-57
Display Commands.....	3-59
DISPLAY Command.....	3-59
Intensity Commands.....	3-60
INTENSITY Command.....	3-60
CONTRAST Command.....	3-60

Measurement Commands.....	3-62
MSLIST Command.....	3-62
MEAS? Query Command.....	3-63
AUTOMEASURE Command.....	3-63
Miscellaneous Commands.....	3-65
SELFCAL Command.....	3-65
CALSTATUS? Query Command.....	3-66
REDIRECT Command.....	3-66
DEBUG Command.....	3-66
LONGFORM Command.....	3-66
TIME Command.....	3-66
DATE Command.....	3-67
DT Command.....	3-67
ABSTOUCH Command.....	3-67
FPANEL Command.....	3-67
INIT Command.....	3-68
HELP? Query Command.....	3-68
DATIME? Query Command.....	3-69
UPTIME? Query Command.....	3-69
POWERON? Query Command.....	3-69
CALIBRATOR Command.....	3-69
SPEAKER Command.....	3-70
Probe ID Commands.....	3-73
PROBE Command.....	3-73
RS-232-C Control Commands.....	3-74
RS232 Command.....	3-74
Status and Event Commands.....	3-77
RQS Command.....	3-77
SRQMASK Command.....	3-78
EVENT? Query Command.....	3-78
EVQTY? Query Command.....	3-78
ALLEV? Query Command.....	3-78
ID? Query Command.....	3-79
STBYTE? Query Command.....	3-79
IDPROBE? Query Command.....	3-79
VERSION? Query Command.....	3-79
CONFIG? Query Command.....	3-79
Store Recall Commands.....	3-82
RECALL Command.....	3-82
STORE Command.....	3-82
ERASE Command.....	3-82
Text Commands.....	3-83
TEXT Command.....	3-83
Time Base Commands.....	3-84
TBDISPLAY Command.....	3-84
TBGATEOUT Command.....	3-84
TBMAIN & TBDELAY Commands.....	3-85
Trigger Commands.....	3-87
TRMAIN, TR1DELAY & TR2DELAY, and TRAEXT & TRBEXT Commands.....	3-87

Trigger Holdoff Commands.....	3-91
HOLDOFF Command.....	3-91
HOEVENT Command.....	3-93
HOCOUNTDOWN Command.....	3-93
Waveform Commands.....	3-95
TRACE<ui> Command.....	3-96
SELECT Command.....	3-96
CLEAR Command.....	3-97
Window Delay Commands.....	3-100
WIN1 & WIN2 Commands.....	3-100
Window Trigger Commands.....	3-101
WTMODE Command.....	3-101
Abbreviating Command Set Words.....	3-102
Character Set.....	3-106
Status and Event Reporting.....	3-109
Using SRQ with IEEE-488.....	3-109
Using SRQ with RS-232-C.....	3-109
Masking and Controlling Requests.....	3-109
RQS Command.....	3-109
SRQMASK Command.....	3-111
Event Reporting.....	3-111
Event Handling.....	3-112
Reading the Event Registers.....	3-112
SRQ Responses.....	3-114
Status Byte Definition.....	3-114
Event Code Definition.....	3-116
Event Priorities.....	3-117
Event Codes.....	3-118
System Performance Considerations.....	3-125
Know Your System.....	3-125
Estimating System Performance.....	3-126
Optimizing System Performance Factors.....	3-131
Programming Applications.....	3-135
Utility Programs For HP 200 & 300 Series Controllers.....	3-135
Utility Programs For IBM PC-XT-AT Controllers.....	3-142

Specification

Electrical Characteristics.....	4-1
Environmental Characteristics.....	4-35
Physical Characteristics.....	4-37
Dimensional Drawings.....	4-38
System Specification.....	4-40

Instrument Options

Instrument Option Identification.....	5-1
Option 1C.....	5-1
Option 1R.....	5-1
Option 1T.....	5-1
Option A1.....	5-1
Option A2.....	5-1
Option A3.....	5-1
Option A4.....	5-1
Option A5.....	5-1
Option Information Locator.....	5-2

Plug-In Unit Information

11A32 Two Channel Amplifier
 11A34 Four Channel Amplifier
 11A52 Two Channel Amplifier
 11A71 Amplifier

Appendix A—Glossary

Appendix B—Accessory List

Error and Warning Messages

Index

Problem Report

Change Notices

Illustrations

1	Simplified Block Diagram.....	xx
1-1	Installing a plug-in unit in the mainframe.....	1-7
2-1	Front-panel controls, connectors, and indicators.....	2-2
2-2	Rear-panel controls, connectors, and indicators.....	2-4
2-3	BEAM FIND, IEEE488/232, ENHANCED ACCURACY, and AUTOSET buttons.....	2-6
2-4	INTENSITY controls.....	2-7
2-5	CALIBRATOR connections.....	2-8
2-6	Display format.....	2-9
2-7	Knobs and control-menu buttons.....	2-10
2-8	Control-menu buttons.....	2-11
2-9	Control-menu buttons.....	2-12
2-10	Major-menu buttons.....	2-13
2-11	Major-menu buttons.....	2-14
2-12	Front-panel external connectors.....	2-15
2-13	REAR TO FRONT and signal-controlling input/output connectors.....	2-16
2-14	TRIGGER RESET and READY connectors.....	2-17
2-15	Fan, line cord socket, PRINCIPAL POWER SWITCH, fuse, and LINE VOLTAGE SELECTOR.....	2-18
2-16	IEEE-488 (GPIB), and RS-232-C interface connectors.....	2-19
2-17	The PRINCIPAL POWER SWITCH (rear panel) and ON/STANDBY switch (front panel).....	2-21
2-18	State diagram for Enhanced Accuracy.....	2-24
2-19	Enhanced Accuracy indicator on the lower right of screen.....	2-25
2-20	Display Format.....	2-31
2-21	The Vertical menu with AC Coupling selected.....	2-32
2-22	The Vertical menu with DC Coupling selected.....	2-33
2-23	The prompt line, the knob setting line, and the two-line menu lines. This menu is On.....	2-34
2-24	When the menu is Off, only the prompting and knob setting line appears.....	2-34
2-25	The Vertical menu with a helpful message.....	2-38
2-26	Autoset menu.....	2-40
2-27	The HORIZONTAL DELAY menu for windows and YT traces.....	2-47
2-28	The HORIZONTAL DELAY menu for windows and YT traces.....	2-51
2-29	HORIZONTAL SIZE and POSition control menu for YT traces.....	2-52
2-30	XY Horizontal Menu.....	2-53
2-31	The DELAY (Offset) menu for an XY trace.....	2-54
2-32	HORIZONTAL SIZE and POSition control menu for an XY trace.....	2-54
2-33	HORIZONTAL SIZE and POSition control menu for a YT trace.....	2-55
2-34	The left control knob is assigned for R1 input.....	2-58
2-35	The right control knob is assigned to supply the offset for C1 even though it cannot be displayed vertically.....	2-58
2-36	Probe ID selection from the Utility menu.....	2-60
2-37	Control menu for a single-end amplifier.....	2-66
2-38	Count View selection in the WAVEFORM major menu.....	2-68
2-39	Reference selected in the WAVEFORM menu.....	2-69

2-40	Scope selected in the WAVEFORM major menu.....	2-70
2-41	Procedure for creating the trace "L1+C2".....	2-73
2-42	Procedure for correcting mistakes while creating the trace "L1+C2".....	2-74
2-43	The TRIGGER LEVEL control menu and status.....	2-86
2-44	TRIGGER SOURCE major menu plugs TRIGGER control menu.....	2-89
2-45	This example shows the selections (right half of menu) available for the Dly1 trigger source. The Dly2 trigger source menu offers the same selections.....	2-90
2-46	The DELAY control menu for YT traces.....	2-95
2-47	The DISP ADJ (Display Adjust) major menu.....	2-98
2-48	Crosshatch pattern 1 is useful for setting focus and astigmatism, and checking geometry and linearity.....	2-99
2-49	Pattern 2 is used during calibration to cancel "spot shift".....	2-100
2-50	The COUNTER control menu showing the measured results for FREQUENCY.....	2-109
2-51	The Counter control menu showing the measured results for Period.....	2-110
2-52	The COUNTER menu choices when using Ratio.....	2-112
2-53	Precision timing between any two events is provided when using both window 1 and 2. The difference between Dly1 and Dly2 can equal zero.....	2-114
2-54	The COUNTER menu showing the difference between the Main and Dly1 sweep gates as Time M→D.....	2-116
2-55	The COUNTER menu for Total.....	2-117
2-56	The COUNTER menu for Width.....	2-118
2-57	The COUNTER menu before either knob is moved.....	2-120
2-58	Alternate presses of the COUNTER button preserve the knob setting and results.....	2-121
2-59	Here the TRIGGER LEVEL button has been pressed, calling up its own menu while the results of the Counter/Timer are still displayed.....	2-121
2-60	The NUMERIC ENTRY menu with a relative reference value set...2-123	
2-61	The WAVEFORM menu shows the additional entries from the counter-view signals of the Counter/Timer.....	2-127
2-62	The relationship of Sync Gate to the gating signal and the measured signal.....	2-128
2-63	Simplified Block Diagram with highlighted Counter/Timer paths.....	2-133
2-64	Counter View Traces.....	2-134
2-65	Trigger View trace shows pulses derived from two bursts of different durations.....	2-137
2-66	Gate and Count In pulses.....	2-138
2-67	One advantage of selectable trigger sensitivity.....	2-139
2-68	Precision timing between any two events is provided when using both Window 1 and 2. The difference between Dly1 to Dly2 equal to zero.....	2-142
2-69	Horizontal CURSORS menu with a YT trace selected.....	2-143

2-70	Horizontal CURSORS menu for an XY trace.....	2-144
2-71	Vertical CURSORS menu.....	2-146
2-72	The Vertical CURSORS menu with %dB set to On yielding delta readings in percent and dB.....	2-147
2-73	The Horizontal CURSORS menu for a YT trace with % Degree set to On.....	2-147
2-74	The measurement list with four choices (P-P, Per, Mid, Duty) selected.....	2-149
2-75	The results of eight measurements chosen from the measurement list as well as the trace measured and the time and date "stamp".....	2-150
2-76	The numeric entry modify approach.....	2-153
2-77	The numeric entry new number approach.....	2-154
2-78	The NUMERIC ENTRY major menu.....	2-155
2-79	Stored settings menu selections.....	2-160
2-80	STORE/RECALL menu illustrating the Prompt/Message line.....	2-161
2-81	Autoset menu.....	2-164
2-82	Beep menu.....	2-165
2-83	Cal menu.....	2-166
2-84	Calibrator Signal menu.....	2-167
2-85	Extended Test menu.....	2-168
2-86	GPIB menu.....	2-169
2-87	Initialize menu.....	2-171
2-88	I/O BNC menu.....	2-172
2-89	Probe Calibration menu.....	2-173
2-90	Probe ID selection.....	2-174
2-91	The Probe Skew menu.....	2-175
2-92	RS-232-C menu.....	2-176
2-93	The Test menu.....	2-177
2-94	Time and Date selected from the UTILITY major menu.....	2-178
2-95	The MEASURE major menu.....	2-180
2-96	The MEASURE menu display after touching Start.....	2-181
2-97	CURSORS menu after selecting vertical cursors.....	2-182
2-98	Cursors set to peaks of displayed waveform, and p-p voltage (ΔV).....	2-183
2-99	Cursor Menu with Horizontal cursors selected and %Degree set to On.....	2-184
2-100	Selecting one cycle with the Horizontal cursors.....	2-185
2-101	Phase angle result.....	2-186
2-102	Input signal displayed.....	2-187
2-103	Setting VERTICAL SIZE and POSition.....	2-188
2-104	Aligning the rising edge using HORIZONTAL POSition.....	2-189
2-105	10X Magnified signal.....	2-190
2-106	Setting the cursors to measure rise time.....	2-191
2-107	Counter/Timer menu.....	2-192
2-108	Setting the WAVEFORM menu for Counter View.....	2-193
2-109	Two traces vertically separate.....	2-194
2-110	Counter/Timer menu with Dly1 Swp gating selected.....	2-195
2-111	The WAVEFORM major menu with Count View selected, and the Count View menu with Gate selected.....	2-196

2-112	Adjusting Dly'd Time/div through HORIZONTAL SIZE menu.....	2-197
2-113	Adjusting the DELAY.....	2-197
2-114	Gated frequency display.....	2-198
2-115	Delay menu with Window 2 set to On.....	2-200
2-116	Setting delays for propagation delay measurement.....	2-201
2-117	Time between events displayed as Time D1→D2 in message area....	2-202
3-1	GPIB & RS-232-C Ports (Rear Panel View).....	3-1
3-2	Functional Partition Within A Device.....	3-6
3-3	Asynchronous Serial Transmission.....	3-7
3-4	GPIB System Configurations.....	3-9
3-5	RS-232-C Point-to-point Connection.....	3-10
3-6	RS-232-C Port Pinouts.....	3-11
3-7	Typical GPIB Settings.....	3-13
3-8	Typical RS-232-C Settings.....	3-14
3-9	11301/11302 Command Syntax Elements.....	3-15
3-10	Setting Retrieval Example Programs for HP 200/300 Series.....	3-21
3-11	Examples of RS-232-C Connections.....	3-37
3-12	Binary Transfer Operation.....	3-54
3-13	Examples of valid commands with and without abbreviations.....	3-102
3-14	RQS/SRQ Button and Light On the oscilloscope Front Panel.....	3-110
3-15	Event Handling.....	3-113
3-16	System Performance Elements.....	3-126
3-17	System Limitations On Data Transfer Rates.....	3-127
3-18	Data Transfer Time Components.....	3-128
3-19	Data Input and Output Operations.....	3-128
3-20	11301/11302 RS-232-C Data Transfer.....	3-129
3-21	Front-panel Settings from the 1130X—ASCII Format.....	3-135
3-22	Front-panel Settings from the 1130X—Binary Format.....	3-136
3-23	Automatic Measurement Operation—String Response.....	3-137
3-24	Automatic Measurement Operation—Array Response.....	3-138
3-25	Counter Timer Frequency Measurements.....	3-140
3-26	Waveform Transfer to the 1130X—Binary Format.....	3-141
3-27	Waveform Transfer to the 1130X—ASCII Format.....	3-142
3-28	Front Panel Settings from the 1130X—ASCII Format.....	3-143
3-29	Automatic Measurement Operation—String Format.....	3-144
3-30	Counter Timer Frequency Measurements.....	3-145
3-31	Waveform Transfer to the 1130X—ASCII Format.....	3-146
3-32	Device Clear Operation.....	3-146
4-1	Bench Model.....	4-38
4-2	Rackmount Model.....	4-39

Tables

1-1	Power-Cord Conductor Identification.....	1-3
1-2	Power-Cord and Plug Identification.....	1-4
1-3	Test Equipment.....	1-11
2-1	Initial Oscilloscope Conditions.....	2-27
2-2	Knob Assignments.....	2-36
2-3	Function Choices of the Autoset Menu.....	2-44
2-4	Horizontal Delay Menu.....	2-46
2-5	Horizontal Size and Position Menu Choices.....	2-50
2-6	Menu choices for DELAY.....	2-50
2-7	Execution Priority.....	2-61
2-8	Possible Choices for a Nondifferential Amplifier.....	2-65
2-9	Holdoff Menu.....	2-77
2-10	Holdoff Previous and Next Menu.....	2-78
2-11	Holdoff Events Menu.....	2-78
2-12	Holdoff Operation.....	2-79
2-13	Minimum Holdoff Time for 2ns Step, Countdown and Events.....	2-81
2-14	Trigger Level Menu Functions and States.....	2-83
2-15	Trigger Delay Choices.....	2-83
2-16	External Trigger Choices.....	2-84
2-17	Trigger Source Selection and Choices.....	2-89
2-18	Significant Digits for Frequency.....	2-108
2-19	Menu Choices for Frequency Measurements.....	2-109
2-20	Significant Digits for Period.....	2-110
2-21	Menu Choices for Period Measurements.....	2-111
2-22	Menu Choices for Ratio Measurements.....	2-111
2-23	Significant Digits for Time A→B (M→D Trig, CT Ext A & B and Sweeps) and Width.....	2-113
2-24	Significant Digits for Time A→B (Time D2→D1 Sweeps).....	2-115
2-25	Menu Choices for Time A→B Measurements.....	2-116
2-26	Menu Choices for Total Measurements.....	2-117
2-27	Menu Choices for Width Measurements.....	2-118
2-28	Format for Zero Reference and NUMERIC ENTRY Off.....	2-124
2-29	Format for Nonzero Reference or NUMERIC ENTRY On.....	2-125
2-30	Synopsis of Counter Views.....	2-129
2-31	Horizontal Cursor Measurements for YT Traces.....	2-144
2-32	Horizontal Cursor Measurements for XY Traces.....	2-145
2-33	Vertical Cursor Measurements.....	2-146
3-1	Examples of Set Commands.....	3-16
3-2	Examples of Queries.....	3-18
3-3	I/O Buffer Sizes.....	3-32
3-4	RS-232-C & GPIB Interface Messages.....	3-34
3-5	Autoset Commands.....	3-38
3-6	Channel Commands.....	3-40
3-7	Counter/Timer Commands.....	3-43
3-8	NRx Argument Ranges.....	3-44
3-9	Cursor Commands.....	3-48
3-10	Data Transfer Commands.....	3-52

3-11	Diagnostic Commands.....	3-57
3-12	Display Command.....	3-59
3-13	Intensity Commands.....	3-60
3-14	Measurement Commands.....	3-62
3-15	Measure Argument Links.....	3-62
3-16	Miscellaneous Commands.....	3-65
3-17	Touch Translation Table Layout.....	3-68
3-18	RS-232-C Control Commands.....	3-74
3-19	Status and Event Commands.....	3-77
3-20	Store Recall Commands.....	3-82
3-21	Text Command.....	3-83
3-22	Time Base Commands.....	3-84
3-23	Time Base Resolution.....	3-85
3-24	Trigger Commands.....	3-87
3-25	Trigger Holdoff Commands.....	3-91
3-26	Minimum Holdoff Time for 2ns Step, countdown and Events.....	3-92
3-27	Waveform and Settings Commands.....	3-95
3-28	Window Delay Commands.....	3-100
3-29	Window Trigger Command.....	3-101
3-30	Command Word Abbreviations.....	3-103
3-31	ASCII Character Set.....	3-106
3-32	Escaped Character Set.....	3-107
3-33	11304/11302 Status Bytes.....	3-115
3-34	Event Code Classes.....	3-116
3-35	Event Priority.....	3-117
3-36	Command Errors.....	3-118
3-37	Execution Errors.....	3-119
3-38	Internal Errors.....	3-121
3-39	System Events.....	3-121
3-40	Execution Warnings.....	3-123
3-41	Internal Warnings.....	3-124
4-1	Electrical Specification.....	4-1
4-2	Environmental Characteristics.....	4-35
4-3	Physical Characteristics.....	4-37
4-4	System Bandwidth and Rise Time.....	4-40
4-5	Accuracy with 11A71 Amplifier.....	4-41
4-6	Accuracy with 11A52 Two Channel Amplifier.....	4-41
4-7	Accuracy with 11A32 Two Channel Amplifier and 11A34 Four Channel Amplifier.....	4-42
5-1	Option Information Locator.....	5-2

Operators Safety Summary

The following general safety information applies to all operators and service personnel.

Terms

In Manuals

CAUTION statements identify conditions or practices that could result in damage to the equipment or other property.

WARNING statements identify conditions or practices that could result in personal injury or loss of life.

As Marked On Equipment

CAUTION indicates a personal injury hazard not immediately accessible as one reads the marking, or a hazard to property including the equipment itself.

DANGER indicates a personal injury hazard immediately accessible as one reads the marking.

Symbols

In Manuals

 Static-Sensitive Devices

As Marked On Equipment

 **DANGER**—High voltage.

 Protective ground (earth) terminal.

 **ATTENTION**—refer to manual.

Warnings

Power Source

This product is intended to operate from a power source that will not apply more than 250 volts rms between the supply conductors or between either supply conductor and ground. A protective ground connection, by way of the grounding conductor in the power cord, is essential for safe operation.

Grounding the Instrument

The 11301 and 11302 are grounded through the grounding conductor of the power cord. To avoid electric shock, plug the power cord into a properly wired receptacle, where earth ground has been verified by a qualified service person, before making connections to the input or output terminals of the instrument. A protective-ground connection, by way of the grounding conductor in the mainframe power cord, is essential for safe operation.

Danger Arising From Loss of Ground

Upon loss of the protective-ground connection, all accessible conductive parts (including knobs and controls that may appear to be insulating), can render an electric shock.

Use the Proper Fuse

To avoid fire hazard, use only the fuse specified in the parts list for your product, and which is identical in type, voltage rating, and current rating.

Do Not Operate In Explosive Atmospheres

To avoid explosion, do not operate the instrument in an atmosphere of explosive gasses.

Do Not Remove Covers or Panels

To avoid personal injury, do not remove the protective covers. Do not operate this instrument without the panels or covers properly installed.

Introduction

The 11301 Programmable Oscilloscope is a 400 MHz Analog real-time oscilloscope mainframe. The oscilloscope provides for up to three 11000-Series plug-in units and features two built-in analog time bases. Extensive microprocessor facilities increase measurement accuracy and improve human interpretation of the measurement results.

The 11302 is basically the same as the 11301 except that the 11302 has a micro-channel plate crt for increased writing rate and a bandwidth of 500 MHz. (See Table of Contents, "11302 Differences.")

The bench model oscilloscope can be converted into a rackmount model using a rackmount kit. See Appendix B.

This manual contains complete operating instructions for both the 11301 and the 11302 Programmable Oscilloscopes. However, this manual is not intended to be a procedural guide for a novice, but a guide for those already familiar with oscilloscope fundamentals. In this manual you'll find installation instructions, functional operating information, IEEE STD 488 (GPIB) and RS-232-C Interface instructions and examples, instrument specification, and options. The novice should refer to the "Introducing the 11301 and 11302 Programmable Oscilloscopes" manual.

Oscilloscope System Architecture

This description is intended to aid more knowledgeable users in their desire to get the most out of the instrument.

The block diagram (Fig. 1) represents the basic oscilloscope architecture and depicts primary analog paths within the instrument. Not shown are the digital control paths, the processor and its buses, the remote interfaces RS-232-C and IEEE-488), and the various self-calibration pick-offs and sensors.

Although the "brain" of the instrument is the main processor, the "heart" of the measurement capability is the Counter/Timer. The Counter/Timer has access to every signal input into the oscilloscope. It also has a path to the display system to allow you to view the same signals from which the Counter/Timer is performing measurements. In essence, these signals represent the Counter's "view" of what surrounds it. Hence, the name "Counter View" display as found in the WAVEFORM major menu.

Measured Signals

Signals to be measured can originate from the external inputs labeled A and B or from the plug-in compartments. Allowing the signal to be first applied to and amplified by a plug-in extends the usefulness of the Counter/Timer. For example, high impedance sources can be examined by using a very low loading probe. Also, signals of irregular and aperiodic ac components with large dc components can be centered within the triggering range by using a Differential comparator. Such a plug-in can compensate for dc components of 10,000 times the magnitude of the ac component. This is not available with any conventional Counter/Timer.

The amplified signal from the plug-in can take two different paths. It can be viewed on the display, examined by the triggers, or both. It is important to realize that the signal to the triggers need not be from the same source as the signal being displayed. For example, a displayed trace originating from the LEFT compartment can be triggered by a signal from the CENTER compartment. Also, within any plug-in, one channel can be viewed while another channel, not displayed, can be used for triggering.

To define trigger sources for the Main and Delayed time bases, use the major menu called TRIGGER SOURCE. Trigger sources from the LEFT and CENTER plug-in compartments can be combined for a composite algebraic expression. The trigger signal from the RIGHT plug-in compartment cannot be combined with the others. However, composite expressions can be created within each plug-in.

The A and B External inputs are routed to the triggers circuits and directly to the Counter/Timer. The External Inputs can be used for triggering sweeps when selected through the TRIGGER SOURCE major menu. However, if the sweeps are to be triggered from one of the other sources, the A and B inputs can still be used by the Counter/Timer because it is completely independent of the Main and Delayed triggers.

Remember, the Counter/Timer measures triggers, not displayed traces.

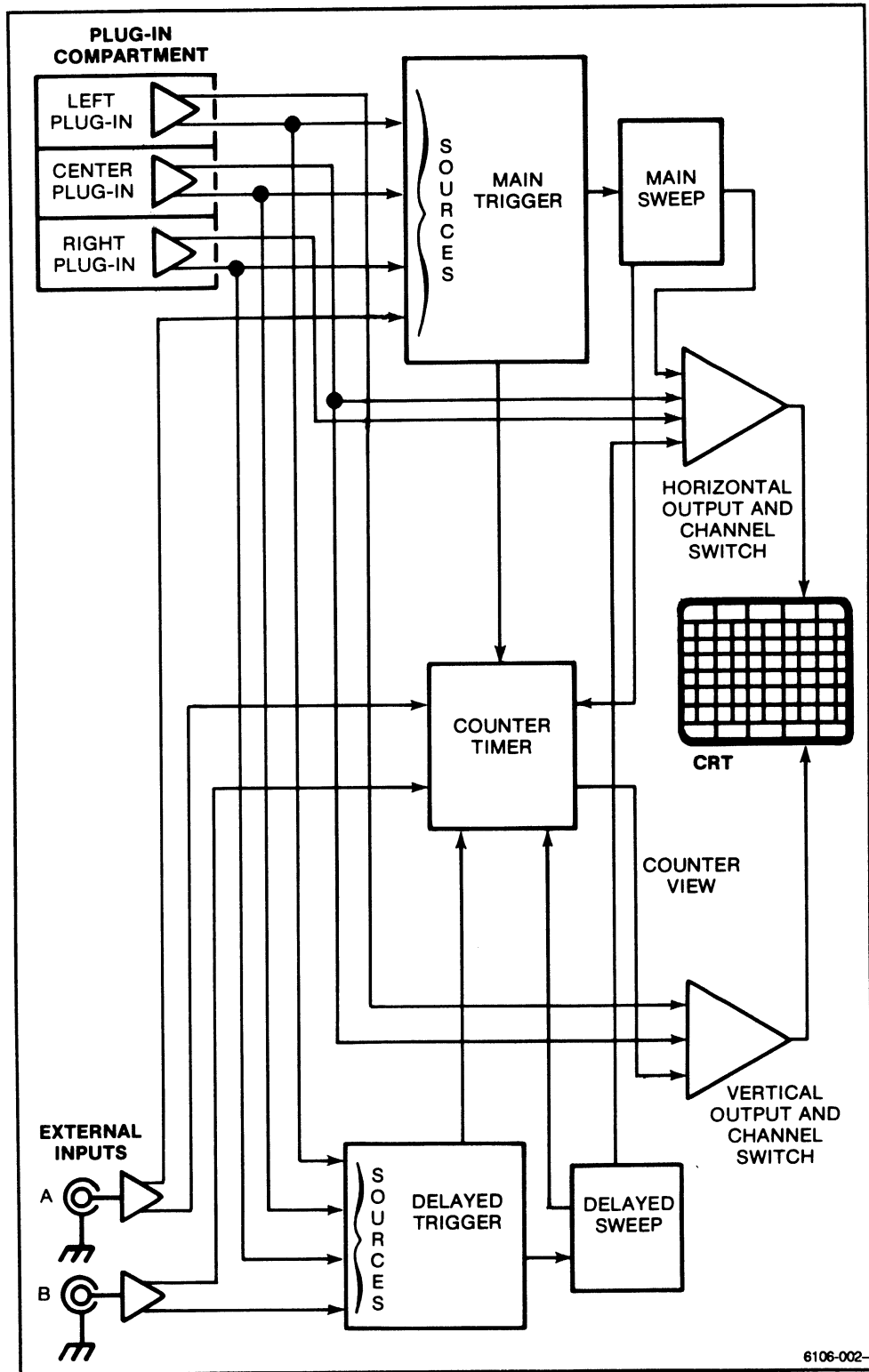

Figure 1. Simplified Block Diagram.

Triggering

In a conventional oscilloscope the triggering circuitry is used to provide a stable display of a desired signal. The triggers produce a processed signal which represents the detection of a signal transition having some predescribed level and direction (polarity). These, of course, are determined by the familiar controls of TRIGGER LEVEL and Slope. Beyond these, the oscilloscope offers three selections (high, medium, and low) of trigger Sensitivity to control the comparator. This greatly enhances the ability of the trigger to reject uncorrelated noise. Also, the trigger rate itself can be controlled through Holdoff.

The trigger circuit produces a series of high to low transitions. These are what the Counter/Timer is actually counting. Therefore, by adjusting the trigger level, sensitivity, and the slope, different characteristics of a signal can be measured.

Counter View Display

For the first time in a single instrument, a display of where and what the counter is actually counting can be obtained. Essentially a "counter's view" of the signal can be compared to the analog version of the signal to determine which features of the signal are being measured. This added display is indispensable as it allows you to adjust and control the measurement with greater precision and confidence.

Measurement Interval

Triggering controls of LEVEL, Slope, and Sensitivity allow for discriminating in the vertical or amplitude dimension. In order to discriminate in the horizontal or time dimension, a signal from the Delayed Sweep generator can be used. This is referred to as Gating the Counter/Timer. By use of the Delay and Size controls, signal features can be excluded easily. Because the delayed sweep is time correlated to the triggers, it is especially convenient for gating. This means that the event which triggers the main sweep can be used to begin a delay period during which no measurements will be made. When the delay expires, measurements are allowed to commence. Measurements do not start immediately, however. They are permitted to start only if the trigger conditions are satisfied.

Of course, once permitted to start, the measurements must again be inhibited at the end of the gate interval. This length of time is determined by the delayed sweep time, approximately 10 times the Delayed Window Time/div setting.

The External A and B inputs can also be used to gate a measurement. When both A and B inputs are used together to create a gate, the gate interval begins on the rising edge of the A input and the interval ends on the falling edge of the B input signal. The B input alone can be selected for gating. Here, the rising edge of B starts the interval and the falling edge of B stops the interval. Whenever both A and B inputs are used together to define the gate interval, these inputs cannot be used as measurement sources.

Display Paths

In addition to the already mentioned "Counter View" signals, the plug-in compartments provide the most common source of displayed signals. The LEFT and CENTER compartment paths have a vertical deflection bandwidth of up to the full bandwidth of the instrument. The LEFT compartment can be used only for vertical deflection in the display. The CENTER can be used for both vertical and horizontal deflection. This allows for simultaneous display of XY and YT traces. The RIGHT compartment can be used for horizontal deflection only when used for part of an XY trace. The horizontal bandwidth is a maximum of 3 MHz. The CENTER compartment is phase matched to within 1 degree at 1 MHz and approximately 3 degrees at 2 MHz.

Section 1

Installation

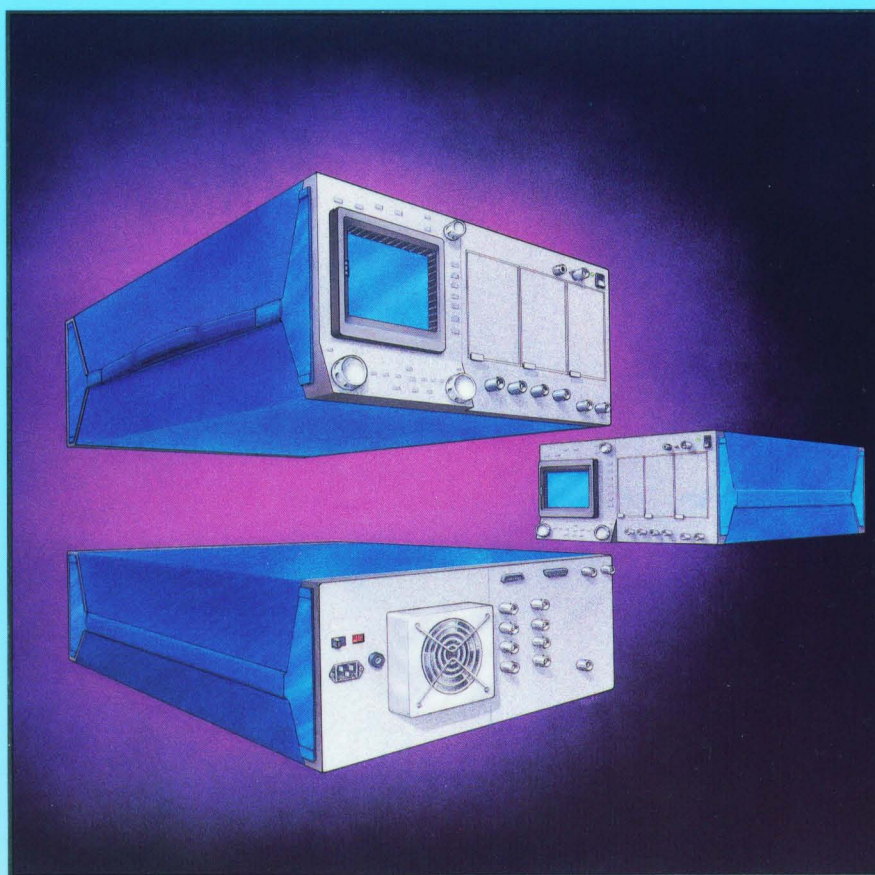

Contents

Operating Power Information.....	1-2
Memory Back-Up Power.....	1-2
Operating Voltage.....	1-3
Power Cord Information.....	1-3
Operating Environment.....	1-5
Operating Temperature.....	1-5
Ventilation Requirements.....	1-5
Plug-In Unit Operating Information.....	1-6
Installing Plug-In Units.....	1-6
External Interface Connection.....	1-8
Packaging for Shipment.....	1-8
Shipping the Instrument.....	1-8
Shipping to Tektronix Service Center.....	1-8
Substituting Original Packaging.....	1-9
Rackmounting.....	1-9
Incoming Inspection and Performance Verification.....	1-10
Using This Procedure.....	1-10
Plug-in Unit Installation and Removal.....	1-11
Test Equipment.....	1-11
1. Setup	1-14
2. Test (Automatic Self-Test).....	1-15
3. Enhanced Accuracy.....	1-16
4. Probe Calibration.....	1-17
5. Initialization and Autoset.....	1-18
6. Input Accuracy.....	1-19
7. System Bandwidth.....	1-20
8. Window (Delay Time) Displays.....	1-22
9. Counter/Timer and Measure.....	1-23
10. External Inputs and Counter-View Traces.....	1-25

Installation

This section gives all the information needed to apply power and check to that the 11301 or 11302 Programmable Oscilloscope is operational.

Information on operating voltage and power cord needs as well as environmental conditions such as operating temperature and ventilation requirements is included here. Plug-in installation and compatibility to this 11000-Series mainframe is also explained.

Once the oscilloscope is turned on, this section also guides you through an Incoming Inspection Procedure to verify that you have indeed received a working instrument. If there is damage or deficiency, contact your local Tektronix Field Office or representative.

You'll also find information on how to interface the oscilloscope to instruments with GPIB (IEEE-488) and RS-232-C features. Information on how to convert a bench model into a rackmount model or vice versa is also found in this section.

Finally, there are instructions on how to package your oscilloscope if you ever need to return it for repair.

Operating Power Information

This instrument can be operated from either a 115-volt or 230-volt nominal line-voltage source, 48 to 440 hertz. The 6-ampere, 250-volt line fuse is used for both 115-volt and 230-volt operation.

WARNING

AC POWER SOURCE AND CONNECTION. The oscilloscope operates from a single-phase power source. It has a three-wire power cord and two-pole, three-terminal grounding type plug. The voltage to ground (earth) from either pole of the power source must not exceed the maximum rated operating voltage, 250 volts.

Before making connection to the power source, check that the oscilloscope LINE VOLTAGE SELECTOR on the rear of the instrument is set to match the voltage of the power source and has a suitable two-pole, three-terminal grounding-type plug. Refer any changes to qualified service personnel.

GROUNDING. This instrument is safety Class 1 equipment (IEC designation). All accessible conductive parts are directly connected through the grounding conductor of the power cord to the grounded (earthing) contact of the power plug.

The power input plug must be inserted only in a mating receptacle with a grounding contact where earth ground has been verified by a qualified service person. Do not defeat the grounding connection as any interruption of the grounding connection can create an electric shock hazard.

For electric shock protection, the grounding connection must be made before making connection to the input or output terminals of the instrument.

Memory Back-Up Power

This oscilloscope is equipped with a battery to save the most recent operating conditions between power on/off cycles. The self-test will display a message to indicate when the battery needs to be replaced.

The battery has a nominal shelf life of approximately five years. Partial or total loss of stored settings upon power-up may indicate that the battery needs to be replaced.

Operating Voltage

The LINE VOLTAGE SELECTOR (located on the rear panel) allows you to select 115-volt or 230-volt nominal line-voltage operation. The same line fuse is used for both 115-volt and 230-volt operation. Refer voltage conversion to qualified service personnel.



Power Cord Information

A power cord with the appropriate plug configuration is supplied with each instrument. Table 1-1 gives the color coding of the conductors in the power cord. If you require a power cord other than the one supplied, refer to Table 1-2, Power-Cord and Plug Identification.

TABLE 1-1
Power-Cord Conductor Identification

Conductor	Color	Alternate Color
Ungrounded (line)	Brown	Black
Grounded (neutral)	Light Blue	White
Grounded (earthing)	Green/Yellow	Green

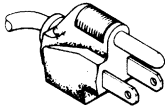
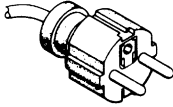
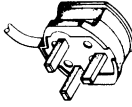
**TABLE 1-2
Power-Cord and Plug Identification**

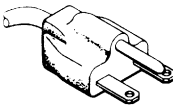
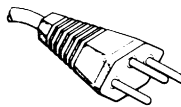
Plug Configuration	Usage (Max Rating)	Reference Standards & Certification	Option #
	North American 125V/6A	¹ ANSI C73.11 ² NEMA 5-15-P ³ IEC 83 ¹⁰ UL ¹¹ CSA	Standard
	European 220V/6A	⁴ CEE (7), II,IV,VII ³ IEC 83 ⁸ VDE ⁹ SEMKO	A1
	United Kingdom 240V/6A	⁵ BSI 1363 ³ IEC 83	A2
	Australian 240 V/6A	⁶ AS C112 ¹² ETSA	A3
	North American 250V/10A	¹ ANSI C73.20 ² NEMA 6-15-P ³ IEC 83 ¹⁰ UL ¹¹ CSA	A4
	Switzerland 240V/6A	⁷ SEV	A5

¹ANSI—American National Standards Institute
²NEMA—National Electrical Manufacturer's Association
³IEC—International Electrotechnical Commission
⁴CEE—International Commission on Rules for the Approval of Electrical Equipment
⁵BSI—British Standards Institution
⁶AS—Standards Association of Australia
⁷SEV—Schweizerischer Elektrotechnischer Verein
⁸VDE—Verband Deutscher Elektrotechniker
⁹SEMKO—Swedish Institute for Testing and Approval of Electrical Equipment
¹⁰UL—Underwriters Laboratories
¹¹CSA—Canadian Standards Association
¹²ETSA—Electricity Trust of South Australia

Operating Environment

The following environmental requirements are provided to ensure proper operation and long life of the instrument. To prevent damage to the 11301 or 11302 Programmable Oscilloscope certain environmental conditions must be met. See Section 4, "Specification," for a more complete list.

Operating Temperature

This instrument can be operated where the ambient air temperature is between 0° and +50°C. The Programmable Oscilloscope can be stored in ambient temperature between -40° and +75°C. After storage at a temperature beyond the operating limits, allow the chassis temperature to come within the operating limit before applying power.

Ventilation Requirements

To prevent damage to the Programmable Oscilloscope from overheated components, adequate internal airflow must be maintained at all times. Before turning on the power, check the air-intake holes for obstructions. Remove any obstructions to air flow and provide both the bench and the rack mount models with a minimum of two inches of clearance at the sides and rear.

A variable speed fan controls the air flow as temperature varies. To maintain adequate cooling, all plug-in compartments must have an 11000 series plug-in unit installed. If active plug-ins are not available, install blank plug-in units (Tektronix Part No. 016-0829-00). Failure to comply with these ventilation requirements violates conditions to which the advertised specifications (i.e., accuracy) apply.

CAUTION

The power supply of this instrument may temporarily shut down if air flow is restricted.

Plug-In Unit Operating Information

Section 6, "Plug-in Unit Information," contains an operating information supplement for each plug-in unit that was available when you received this mainframe.

Because the plug-in units are operated through the front panel and its touch screen, their operation is described in this manual.

Functions unique to a plug-in unit will be described in its plug-in supplement.

As new plug-in units are introduced, Tektronix will provide plug-in supplements. When you purchase a new plug-in unit, insert the new plug-in supplement in Section 6 of this manual.

Installing Plug-in Units

CAUTION

Before installing or removing plug-in units set the front-panel ON/STANDBY switch to STANDBY. Damage to the instrument may result if you install or remove a plug-in unit with the power on.

To install a plug-in unit into the mainframe, align the grooves in the top and bottom of the plug-in with the respective guides in the plug-in compartment of the mainframe. Then push the plug-in unit in until its front panel is flush with the front-panel frame. See Figure 1-1.

To remove a plug-in, pull out the latch to disengage it from the mainframe plug-in compartment lock, then slide the plug-in out.

Operating Environment

The following environmental requirements are provided to ensure proper operation and long life of the instrument. To prevent damage to the 11301 or 11302 Programmable Oscilloscope certain environmental conditions must be met. See Section 4, "Specification," for a more complete list.

Operating Temperature

This instrument can be operated where the ambient air temperature is between 0° and +50°C. The Programmable Oscilloscope can be stored in ambient temperature between -40° and +75°C. After storage at a temperature beyond the operating limits, allow the chassis temperature to come within the operating limit before applying power.

Ventilation Requirements

To prevent damage to the Programmable Oscilloscope from overheated components, adequate internal airflow must be maintained at all times. Before turning on the power, check the air-intake holes for obstructions. Remove any obstructions to air flow and provide both the bench and the rack mount models with a minimum of two inches of clearance at the sides and rear. To maintain adequate cooling, a variable speed fan controls the air flow as temperature varies.



The power supply of this instrument may temporarily shut down if air flow is restricted.

Plug-In Unit Operating Information

Section 6, "Plug-in Unit Information," contains an operating information supplement for each plug-in unit that was available when you received this mainframe.

Because the plug-in units are operated through the front panel and its touch screen, their operation is described in this manual.

Functions unique to a plug-in unit will be described in its plug-in supplement.

As new plug-in units are introduced, Tektronix will provide plug-in supplements. When you purchase a new plug-in unit, insert the new plug-in supplement in Section 6 of this manual.

Installing Plug-in Units



CAUTION

Before installing or removing plug-in units set the front-panel ON/STANDBY switch to STANDBY. Damage to the instrument may result if you install or remove a plug-in unit with the power on.

To install a plug-in unit into the mainframe, align the grooves in the top and bottom of the plug-in with the respective guides in the plug-in compartment of the mainframe. Then push the plug-in unit in until its front panel is flush with the front-panel frame. See Figure 1-1.

To remove a plug-in, pull out the latch to disengage it from the mainframe plug-in compartment lock, then slide the plug-in out.

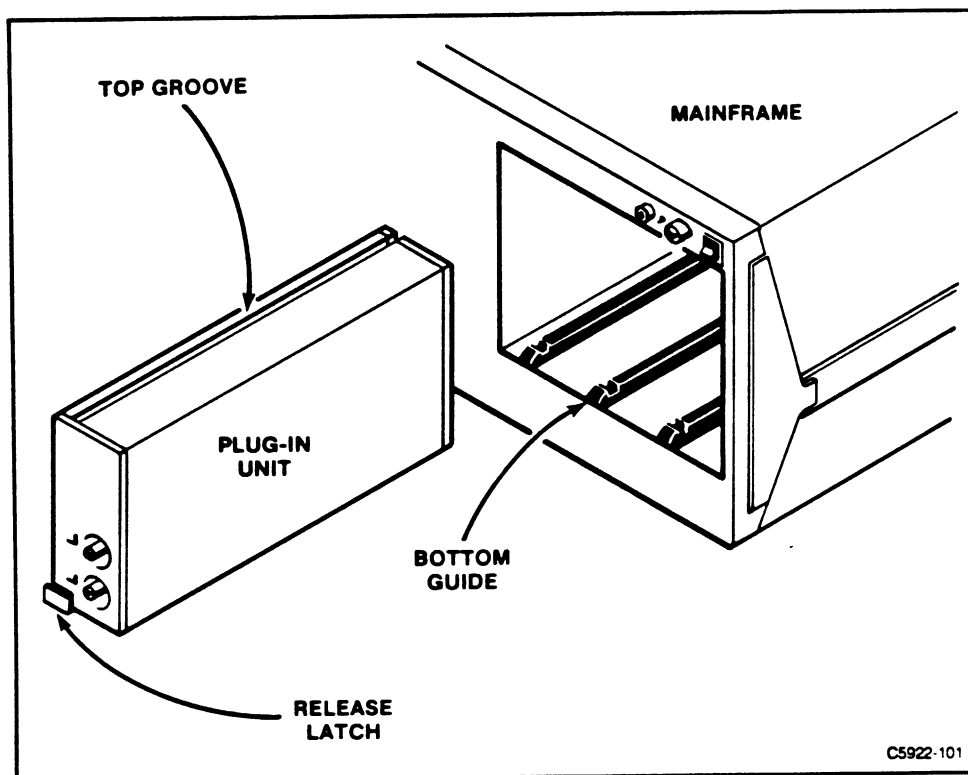

Figure 1-1. Installing a plug-in unit in the mainframe.

It is not necessary that all plug-in compartments be filled to operate the instrument. The only plug-ins needed are those required for the desired measurement.

Accuracy of the plug-in and mainframe combination is maintained by using the ENHANCED ACCURACY feature. This feature requires that the oscilloscope be powered on for at least 20 minutes. (See more on Enhanced Accuracy in Section 2 under "Instrument Verification").

Blank plug-in units must be inserted in unused compartments to maintain proper ventilation and compatibility with electromagnetic emissions, susceptibility and accuracy specifications. Refer to the Optional Accessories list in Appendix B at the rear of this manual for ordering information.

External Interface Connection

On the rear of the Programmable Oscilloscope are two connectors for remote operation: one 24 pin female connector for GPIB (IEEE-488) and one 25 pin female connector for RS-232-C. For further information, refer to Section 3, "GPIB and RS-232-C Interfaces."

Packaging for Shipment

The following information tells you what to do to ship the instrument or to return it for repair even if you do not have the original packaging material.

Shipping the Instrument

If the oscilloscope is to be shipped for long distances by commercial transportation, we recommend that you use the the original packaging material.

Shipping to Tektronix Service Center

If the oscilloscope is to be shipped to a Tektronix Service Center for service or repair, package it in the original shipping material and attach a tag showing the following information:

- a. Owner and address
- b. Name of person who can be contacted
- c. Complete instrument type and serial number
- d. Description of the service required

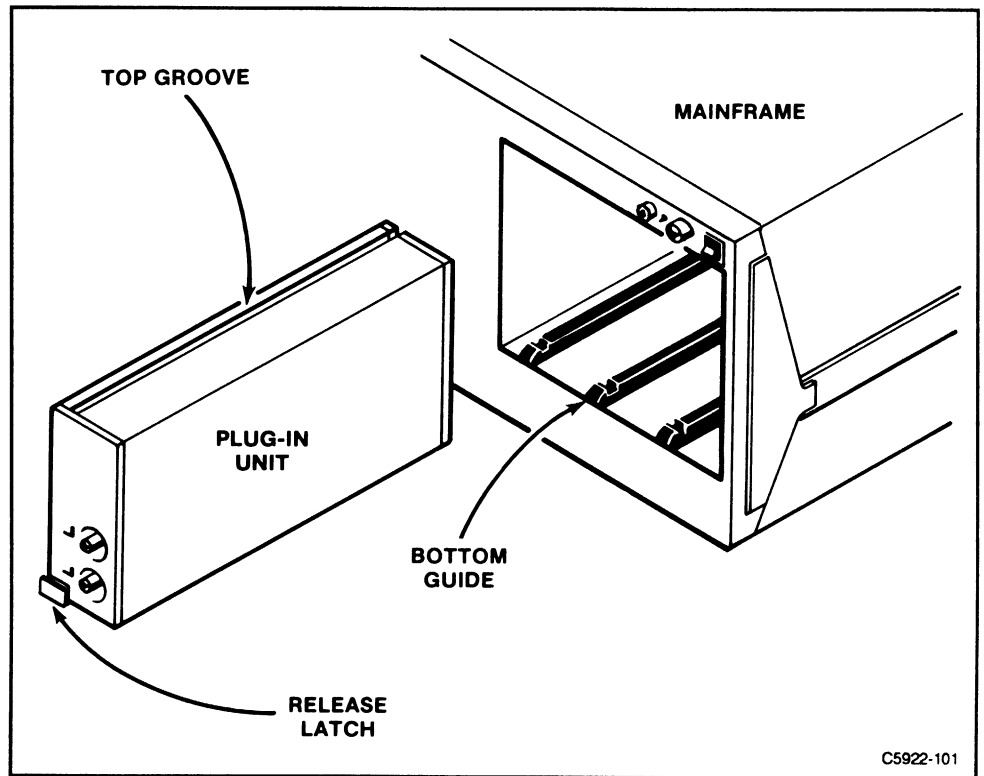

Figure 1-1. Installing a plug-in unit in the mainframe.

It is not necessary that all plug-in compartments be filled to operate the instrument. The only plug-ins needed are those required for the desired measurement.

Accuracy of the plug-in and mainframe combination is maintained by using the ENHANCED ACCURACY feature. This feature requires that the oscilloscope be powered on for at least 20 minutes. (See more on Enhanced Accuracy in Section 2 under "Instrument Verification").

Blank plug-in units should be inserted in unused compartments to maintain compatibility with electromagnetic emissions and susceptibility specifications. Refer to the Optional Accessories list in Appendix B at the rear of this manual for ordering information.

External Interface Connection

On the rear of the Programmable Oscilloscope are two connectors for remote operation: one 24 pin female connector for GPIB (IEEE-488) and one 25 pin female connector for RS-232-C. For further information, refer to Section 3, "GPIB and RS-232-C Interfaces."

Packaging for Shipment

The following information tells you what to do to ship the instrument or to return it for repair even if you do not have the original packaging material.

Shipping the Instrument

If the oscilloscope is to be shipped for long distances by commercial transportation, we recommend that you use the the original packaging material.

Shipping to Tektronix Service Center

If the oscilloscope is to be shipped to a Tektronix Service Center for service or repair, package it in the original shipping material and attach a tag showing the following information:

- a. Owner and address
- b. Name of person who can be contacted
- c. Complete instrument type and serial number
- d. Description of the service required

Substituting Original Packaging

If the original packaging is not reusable or not available, repackage the instrument as follows:

1. Obtain a corrugated cardboard shipping carton with a 275-pound test strength and inside dimensions at least six inches greater than the instrument dimensions (this allows for cushioning material).
2. Wrap the instrument with anti-static sheeting (or equivalent material) to protect the outside finish and prevent entry of packing materials into the instrument.
3. Allowing three inches on each side, cushion the instrument on all sides by tightly packing dunnage or urethane foam between the carton and the instrument.
4. Secure the carton with shipping tape or industrial staples.
5. Mark the address of the Tektronix Service Center and your return address on the carton in one or more prominent locations.

Rackmounting

Option 1R is available to convert the standard benchtop 11301 or 11302 mainframe to a rackmount version. This option allows the oscilloscope to be mounted in a standard 19-inch rack with universal hole spacing. Refer to Section 5, "Instrument Options," for more detail and to Section 4, "Specification," for rackmounting physical dimensions.

Incoming Inspection and Performance Verification

The 11301/11302 self-calibrates against precise internal references when Enhanced Accuracy mode is entered. After an Enhanced Accuracy self-calibration, the accuracy of the instrument and its internal references can be verified by comparing vertical and horizontal measurement results with external standards. The 11301/11302 also performs automatic self-diagnostic routines after each power-up to verify circuit functionality.

The 11301/11302 and 11000-Series plug-in units are verified at the factory to meet the Performance Requirements in Section 4, Specification, and Section 6, Plug-in Unit Information. If additional verification is desired, this procedure may be used for an incoming inspection. It may also be used for periodic performance verification.

WARNING

To avoid personal injury, do not remove the protective cabinet panels or covers. Do not operate this instrument without the panels or covers properly installed.

This procedure is provided for the operator and should be performed with all instrument covers properly installed. Service requiring removal of the protective covers is not included in this procedure and must be performed by qualified service personnel.

Using This Procedure

In this procedure, 11301/11302 front-panel settings may carry over from step to step. Therefore, we recommend that the procedure be performed sequentially.

Initial capital letters within the body of text identify front-panel controls indicators and connectors on associated test equipment (e.g., Amplitude). Words containing all capital letters identify those same types of items on the 11301/11302 (e.g., TRIGGER). Words in **bold** identify labels or messages appearing on the 11301/11302 display (e.g., **InIt**, **Meas List**). Parts of steps beginning with **CHECK** accomplish an electrical specification check.

Plug-in Unit Installation and Removal

The 11301/11302 front-panel ON/STANDBY switch must be set to STANDBY before installing or removing plug-in units. Once returned to ON, the instrument will perform Test diagnostic routines, as detailed later in this procedure, then restore front-panel settings in effect at the time the ON/STANDBY switch was set to STANDBY.

Enhanced Accuracy will **not** be restored immediately after power is restored. Twenty minutes of warmup must elapse before Enhanced Accuracy will again be available. For this reason, if one plug-in unit is used to test more than one plug-in compartment, we suggest performing the entire procedure before moving the plug-in unit to another plug-in compartment.

Test Equipment

Table 1-3 contains examples of test equipment used to perform this procedure. Steps in the procedure are based on the test equipment examples given, but other equipment with similar specifications may be substituted. Test results, setup information, and related connectors and adapters may be altered by the use of different equipment.

TABLE 1-3
Test Equipment

Description	Minimum Specifications	Examples of Applicable Test Equipment
Amplifier	11000-Series compatible. Provides vertical input to the mainframe under test. NOTE <i>The Amplifier/Mainframe combination will determine system bandwidth. Select an Amplifier that will adequately test your bandwidth requirements.</i>	Tektronix 11A-Series Amplifier

**TABLE 1-3 (cont)
Test Equipment**

Description	Minimum Specifications	Examples of Applicable Test Equipment
High Frequency Sine Wave Generator	<p>6 MHz reference; 0-2 V variable amplitude; variable frequency output, 250 MHz minimum, maximum required frequency dependent on the Amplifier/ Mainframe system under test (e.g., 500 MHz for an 11302/11A71 system),</p> <p>Provides signal for checking system bandwidth, measurements, and counter-view.</p>	Tektronix SG 504 Leveled Sine Wave Generator with a TM 500-Series Power Module.
Calibration Generator	<p>Square wave output; 0.25% Accuracy; 2 V output amplitude into 1 MΩ or similar amplitude into 50 Ω (depends on Amplifier).</p> <p>Provides signal for checking AUTOSET, Probe Cal, and input accuracy.</p>	Tektronix PG 506 Calibration Generator with a TM 500-Series Power Module.
Probe	<p>11000-Series compatible, ID button¹, TekProbe connector.</p> <p>Provides connection between front-panel CALIBRATOR and Amplifier to test Probe Cal.</p>	Tektronix P6134 for 1 MΩ inputs, Tektronix P6231 for 50 Ω inputs.

¹The probe must have an ID button; a ground reference button cannot be used to test Probe Cal.

TABLE 1-3 (cont)
Test Equipment

Description	Minimum Specifications	Examples of Applicable Test Equipment
Coaxial Cable	<p>50 Ω, 36-inch, male BNC connectors.</p> <p>Provides signal connection between test equipment and instrument under test.</p>	Tektronix Part No. 012-0482-00
Connector, T	<p>Two female and one male BNC connector.</p> <p>Provides interconnection between the two external Counter inputs and the High Frequency Sine Wave Generator to check Counter View.</p>	Tektronix Part No. 103-0030-00
Termination, Feed-through	<p>50 Ω; one male and one female BNC connector.</p> <p>Provides 50 Ω impedance at External input.</p>	Tektronix Part No. 011-0049-01.
"Blank" 11000 series Plug-in	<p>Required for unused plug-in compartments. Ensures proper ventilation.</p>	Tektronix Part No. 016-0829-00.

1. Setup

- a. Connect the oscilloscope to a suitable power source.
- b. Install an 11000-series Amplifier in the LEFT compartment of the oscilloscope.

NOTE

The Test (self-test) routines can better check instrument operation if plug-in units are installed in all three compartments. If three plug-in units are not available, the power-up sequence should be repeated enough times to ensure that each compartment is tested with a plug-in unit installed. The remainder of the procedure should be repeated for each compartment regardless of the number of plug-in units used.

- c. Set the rear-panel PRINCIPAL POWER SWITCH and front-panel ON/STANDBY switch to ON.

NOTE

When the oscilloscope is first used, the rear-panel PRINCIPAL POWER SWITCH should be set to the ON position and remain there. All subsequent power on/off switching should be done with the front-panel ON/STANDBY switch.

TABLE 1-3 (cont)
Test Equipment

Description	Minimum Specifications	Examples of Applicable Test Equipment
Coaxial Cable	<p>50 Ω, 36-inch, male BNC connectors.</p> <p>Provides signal connection between test equipment and instrument under test.</p>	Tektronix Part No. 012-0482-00
Connector, T	<p>Two female and one male BNC connector.</p> <p>Provides interconnection between the two external Counter inputs and the High Frequency Sine Wave Generator to check Counter View.</p>	Tektronix Part No. 103-0030-00
Termination, Feed-through	<p>50 Ω; one male and one female BNC connector.</p> <p>Provides 50 Ω impedance at External input.</p>	Tektronix Part No. 011-0049-01.

1. Setup

- a. Connect the oscilloscope to a suitable power source.
- b. Install an 11000-series Amplifier in the LEFT compartment of the oscilloscope.

NOTE

The Test (self-test) routines can better check instrument operation if plug-in units are installed in all three compartments. If three plug-in units are not available, the power-up sequence should be repeated enough times to ensure that each compartment is tested with a plug-in unit installed. The remainder of the procedure should be repeated for each compartment regardless of the number of plug-in units used.

- c. Set the rear-panel PRINCIPAL POWER SWITCH and front-panel ON/STANDBY switch to ON.

NOTE

When the oscilloscope is first used, the rear-panel PRINCIPAL POWER SWITCH should be set to the ON position and remain there. All subsequent power on/off switching should be done with the front-panel ON/STANDBY switch.

2. Test (Automatic Self-Test)

Each time the front-panel ON/STANDBY switch is set to ON, the oscilloscope performs automatic self-test routines on its major circuits.

The Test routines check the following circuits:

1. Processor
2. Front Panel
3. Scope Logic
4. Timebase
5. Vertical
6. Left Plug-in Unit
7. Center Plug-in Unit
8. Right Plug-in Unit
9. Plug-in Interface

When Test is successfully completed, in about two minutes, "**TEST PASSED**" will appear on the prompt/message line of the display and the instrument will be ready for use. The message may appear only momentarily as the next prompt will overwrite it.

Failure in any portion of Test will halt the routine and either present an error message on the display or light a combination of major menu labels. Refer this type of failure to qualified service personnel.

3. Enhanced Accuracy

NOTE

Some of the following tests are dependent on the setup of the previous test(s). The note "Beginning a new setup" will indicate that the previous setup will not affect the tests that follow.

- a. After the instrument has been running for at least twenty minutes, press the ENHANCED ACCURACY button on the 11301 /11302 front-panel. The message, "**Press EA Again to confirm request,**" will appear on the display. Press the ENHANCED ACCURACY button again.
- b. After a few seconds of flashing and moving dots, the message, "**ENHANCED ACCURACY IN PROGRESS. APPROX 90 SECONDS TO GO,**" will appear on the display. At the end of that period, front-panel settings that were in effect prior to pressing the ENHANCED ACCURACY button will be restored and the ^EA symbol will appear at the lower right of the display.

During Enhanced Accuracy self-calibration, an internal calibration circuit applies a precision voltage reference to the vertical and horizontal deflection amplifiers. The resulting CRT deflection is read by photodetectors around the graticule and referred to the processor for comparison. Amplifier gain is then automatically adjusted according to the results of the comparison.

Completion of this sequence indicates that the instrument has calibrated itself for its highest state of input accuracy. The accuracy of the system is dependent on the Amplifier and the specification for each Amplifier is given in the System Specification tables in Section 4, Specification.

4. Probe Calibration

NOTE

This step verifies the ability of 11301/11302 to calibrate the Probe as part of the input system. Although other types of probes may be used with the 11301/11302, this step can only be performed with an 11000-Series compatible Probe equipped with a TekProbe connector and an ID button (not the ground reference button found on many other probes).

- a. Press the 11301/11302 UTILITY button to view the Utility major menu.
- b. On the left side of the display area, select **Probe Cal** from the Utility major menu by touching its label.
- c. The message "**Attach one probe to Front Panel Calibrator. Press Probe button when ready.**" appears on the right side of the display.
- d. Connect the Probe from the Amplifier's channel one input connector to the CALIBRATOR probe loop and ground connector.
- e. Press the ID button on the Probe to initiate the calibration.
- f. After a few seconds check for the message, "**Probe cal completed: check LF compensation.**" This indicates successful completion of the automatic routine.
- g. If the Probe has a compensation adjustment, use it to compensate the probe for best waveform flatness.
- h. Press the UTILITY button again to remove the menu.

The oscilloscope system has now been self-calibrated from its probe tip to its CRT.

- i. Remove the Probe if the remainder of the procedure is to be performed.

5. Initialization and Autose

NOTE

Beginning a new setup.

- a. Press the 11301/11302 UTILITY button to view the Utility major menu.
- b. Touch the **Init** label in the Utility major menu. Then touch the screen area that states, "**Touch here to Initialize Scope settings.**"
- c. After the 11301/11302 sets its controls and functions to known states, the message, "**Default initialization of scope complete,**" will be displayed in the messages area of the CRT.
- d. Press the UTILITY button again to remove the menu and the message.
- e. Set the Calibration Generator (not the front-panel CALIBRATOR output; see Table 1-3, Test Equipment) for a standard square-wave output with a frequency between 1 kHz and 100 kHz and amplitude of 2 volts. (If an Amplifier with 50 Ω input impedance is used and the Calibration Generator will not provide a precise 2 volt output into 50 Ω , use a setting that provides an output near 2 volts.)
- f. Connect the Amplifier's channel one input to the Calibration Generator square wave output with a coaxial cable.
- g. Set the Amplifier CH 1 display on/off button to on, then press the AUTOSET button on the 11301/11302 front panel.
- h. Check that the oscilloscope automatically selects the necessary trigger, horizontal, and vertical settings for a stable display of between two and five waveform cycles. Check for waveform amplitude to be at least two but not more than five divisions.

6. Input Accuracy

NOTE

The 11301/11302 must be in Enhanced Accuracy and Initialized to perform the following procedure step.

- a. Press the VERTICAL SIZE button on the 11301/11302 to view the Vertical Offset, Size, and Position control menu.
- b. Set Vertical Size to 500 mV/div (if not already selected by AUTOSET). If a square wave with amplitude other than 2.00 volts is applied, set VERTICAL SIZE to display between four and six divisions of square wave amplitude.
- c. Press the 11301/11302 CURSORS button to view the Cursors control menu.
- d. In the lower right corner of the display, touch the **Cursors** label to select **Vertical Cursors**. (All selections in the Cursors control menu may be stepped through by repeatedly touching the **Cursors** label.)
- e. Use the left control knob (set for FINE resolution) to position the solid line at the minimum value of the waveform.
- f. Use the right control knob (set for FINE resolution) to position the dashed line at the maximum value of the waveform.
- g. **CHECK**—that the peak–peak measurement ΔVert reading is within the accuracy specification given in the System Specification portion of **Section 4, Specification**, for the Amplifier used (e.g., 2 volts ± 0.04 volts for an 11A32 Two Channel Amplifier with 2.00 volts applied to 1 M Ω input impedance).
- h. Disconnect the Calibration Generator from the Amplifier input.

7. System Bandwidth

NOTE

Beginning a new setup. The 11301/11302 must be in Enhanced Accuracy and Initialized to perform the following procedure step.

This portion of the procedure checks the system bandwidth while also checking the operation of several instrument features. System bandwidth is dependent on the Mainframe–Amplifier combination used. To determine the system bandwidth specification for your application, consult the System Specification in Section 4 of this manual.

- a. Press the 11301/11302 UTILITY button to view the Utility major menu.
- b. Touch the **InIt** label in the Utility major menu. Then touch the screen area that states, "**Touch here to initialize Scope settings.**"
- c. Press the UTILITY button again to remove the menu.
- d. Connect the leveled output of the High Frequency Sine Wave Generator to the Amplifier's channel one input connector.
- e. Set the High Frequency Sine Wave Generator Frequency to its Reference output and set the Amplitude control to midrange.
- f. Set the Amplifier CH 1 display on/off button to on and press the 11301/11302 AUTOSET button.
- g. Set sine wave amplitude for exactly six divisions with the High Frequency Sine Wave Generator Amplitude control. Press the FINE button above the left control knob and set VERTICAL POS to center the waveform on the center six divisions.
- h. Press the 11301/11302 CURSORS button to view the Cursors control menu.
- i. Touch the **Cursors** label in the lower right of the screen to select **Vertical Cursors**. (The Cursors control menu selections can be stepped through by repeatedly touching the **Cursors** label.) Two horizontal lines will appear on the display, one solid and one dashed.
- j. Use the left control knob (set for FINE resolution) to position the solid line at the minimum value of the waveform.
- k. Use the right control knob (set for FINE resolution) to position the dashed line at the maximum value of the waveform.
- l. In the Vertical Cursors control menu, touch the **%–dB** label to select **On**. Touch the **Set Ref** label to select **On**. $\Delta\text{Vert}=100.0\%$ should be displayed on the left side of the message area and $\Delta\text{Vert}= 0\text{ dB}$ should appear on the right.

- m. Use the control knobs to position the cursors until $\Delta\text{Vert}=70.7\%$ and -3.01 dB . (The area between the cursors should be approximately centered in the graticule area.)
- n. Set the High Frequency Sine Wave Generator for variable-frequency output and the Frequency control to the maximum bandwidth frequency specified for the system under test (e.g., 300 MHz for a 11301 and 11A32; see "System Specification" in Section 4).
- o. **CHECK**—for the peak-to-peak amplitude of the waveform to be greater than or equal to the displacement of the cursors. The waveform may be repositioned to facilitate visual measurement by pressing the oscilloscope VERTICAL POS button and using the left control knob (set for FINE knob resolution).
- p. Press the CURSORS button to view the Cursors control menu and touch the **Cursors** label repeatedly to select **Off**.

8. Window (Delay Time) Displays

- a. Set the High Frequency Sine Wave Generator output to Reference.
- b. Press the 11301/11302 AUTOSET button.
- c. Press the 11301/11302 HORIZONTAL DELAY (OFFSET) button to view the Horizontal Delay control menu.
- d. In the Horizontal Delay control menu, touch the **View** label to select **Main & Dly** and touch **Window1** to select **On**.
- e. Press the 11301/11302 DISP ADJ (FOCUS) button to view the Display Adjust major menu.
- f. Under **DISP** in the Display Adjust major menu, touch the Δ **Main** label.
- g. Use the right control knob to set Δ **Main Intens** (the contrast between the Main and Delayed waveform intensity levels) to **100.0 %**.
- h. Press the DISP ADJ (FOCUS) button again to remove the menu. The Main waveform should now have an intensified segment and a Delayed waveform should also be visible in the graticule. (If the Delayed waveform is not visible, select DLY'D with the 11301/11302 INTENSITY knob menu buttons and set INTENSITY for a visible Delayed waveform.)
- i. Press the 11301/11302 HORIZONTAL SIZE button.
- j. Use the right control knob (set for FINE resolution) to set the length of the intensified portion so it covers approximately one cycle of the Main waveform.
- k. Press the 11301/11302 HORIZONTAL POS button and use the right control knob to center the Delayed waveform in the graticule.
- l. Press the 11301/11302 HORIZONTAL DELAY button.
- m. Check that the Delayed waveform is a horizontally expanded version of the Main waveform's intensified portion and that the intensified portion can be positioned along the full range of the Main waveform with the right control knob.

9. Counter/Timer and Measure

NOTE

Beginning a new setup. The 11301/11302 must be in Enhanced Accuracy to perform the following procedure step.

- a. Press the 11301/11302 UTILITY button to view the Utility major menu.
- b. Touch the **Init** label in the Utility major menu. Then touch the screen area on the message, "**Touch here to Initialize Scope settings.**"
- c. Press the UTILITY button again to remove the menu.
- d. Connect the leveled output of the High Frequency Sine Wave Generator to the Amplifier's channel one input connector.
- e. Set the Generator Frequency to Reference, and set the Amplitude control to minimum.
- f. Press the Amplifier display on/off button to on and press the 11301/11302 AUTOSET button.
- g. Press the 11301/11302 MEASURE button to view the Measure major menu.
- h. In the Measure menu (on the left side of the screen) touch the **Meas List** label to display the Measurements List on the left side of the screen. Select all the measurements in the **Meas List** by touching each of the measurement labels. All the listed measurements should be shaded to indicate that all measurements will be made.
- i. In the Measure menu, touch the **Start** label to begin the measurements.
- j. When the measurements are complete, **Stop** will be shaded in the Measure menu, the message, "**Measurement block complete,**" will be displayed, and a list of the measured values and a time and date stamp will be displayed on the right side of the screen.
- k. Press the CURSORS button to view the Cursors control menu.
- l. Select **Vertical Cursors** from the Cursors control menu by touching the **Cursors** label.
- m. Using the left control knob (set to FINE resolution), position the solid line at the minimum value of the waveform.
- n. Using the right knob (set to FINE resolution), position the dashed line at the maximum value of the waveform.
- o. **CHECK**—that the Δ Vert reading on the right side of the display message area agrees with the P-P value in the Measurement List.

- p. **CHECK**—that the **Vert Ref** value agrees with the **Min** value in the Measurement List.
- q. Use the left control knob to set the solid cursor line at the maximum value of the waveform.
- r. **CHECK**—that the **Vert Ref** value agrees with the **Max** value given in the Measurement List. (The **Mld** value is a calculated value based on the **Min** and **Max** measurement.)
- s. In the Cursors control menu, select **Horiz Cursors** by touching the **Cursors** label.
- t. Use the left control knob (set for **FINE** resolution) to align the solid cursor line on the point where a waveform edge intersects the center horizontal graticule line.
- u. Use the right control knob (set for **FINE** resolution) to align the dashed cursor line with the same crossing point on the next cycle to the right.
- v. **CHECK**—that the **ΔHoriz** value on the right side of the display settings area agrees with **Per** (Period) in the Measurements List; and **1/ΔHoriz** at the left agrees with **Freq. Duty**, in the Measurement List, should be approximately 50%, and **Wld** (Width) should be about half the **Per** (Period) reading.
- w. Disconnect the High Frequency Sine Wave Generator from the Amplifier input.

10. External Inputs and Counter–View Traces

NOTE

Beginning a new setup. The 11301/11302 must be in Enhanced Accuracy to perform the following procedure step.

- a. Press the 11301/11302 UTILITY button to view the Utility major menu.
- b. Touch the **Init** label in the Utility major menu. Then touch the screen area that states, "**Touch here to initialize the Scope settings.**"
- c. Press the UTILITY button again to remove the menu.
- d. Connect a T Connector to the A EXTERNAL TRIGGER & COUNTER input. Install a 50 Ω Termination on the B EXTERNAL TRIGGER & COUNTER input and connect a coaxial cable between the Termination and one side of the T Connector. Connect a High Frequency Sine Wave Generator to the remaining side of the T Connector.
- e. Set the High Frequency Sine Wave Generator Amplitude to approximately 1 volt and Frequency to 250 MHz.
- f. Press the 11301/11302 TRIGGER SOURCE button to view the Trigger Source major menu. On the left side of the screen, touch **Main**. On the right side of the screen, touch **A Ext** and **Enter**.
- g. Check that the 11301/11302 M TRIG'D indicator is illuminated.
- h. To display counter–view traces, press the WAVEFORM button. On the left side of the screen, touch the **Count View** label.
- i. To select both A & B External inputs in the Count View menu, touch **A Ext** then touch **Enter**; then, touch **B Ext** then touch **Enter**. Set 11301/11302 HORIZONTAL SIZE to 10 ns/div and adjust MAIN INTENSITY as necessary to view two waveforms, each approximately one division in amplitude. If the waveforms are superimposed, one may be repositioned with the left control knob.
- j. Press the 11301/11302 TRIGGER SOURCE button to view the Trigger Source menu. On the left side of the screen, touch **Dly1**. On the right side of the screen, touch **B Ext** and **Enter**.
- k. Press the 11301/11302 HORIZONTAL DELAY (OFFSET) button to view the Horizontal Delay control menu. In the Horizontal Delay control menu, select **Trig'd After Dly** and set **Window1** to **On**.
- l. Check that the 11301/11302 D TRIG'D indicator is illuminated.

Successful completion of this procedure for each plug–in compartment verifies the accuracy of key measurement functions and checks the functionality of the 11301/11302. Refer any problems encountered in this procedure to qualified service personnel.

Operating Information

Oscilloscope Familiarization

Controls, knobs, and connectors are discussed in detail. Information on using the principal power switch and the ON/STANDBY switch is provided. Initialization conditions are listed.

Display Area

The general behavior of control menus and major menus are explained. The touch panel and the conventions of the display format are presented.

Waveform Acquisition

This subsection contains all the information needed to acquire a waveform and view it on screen. Acquiring a waveform via the probe ID button is also discussed.

Triggering

Triggering in its entirety is discussed here. This includes Trigger Holdoff, Trigger Level, and Trigger Source menus. Restrictions for trigger source and composite traces are listed.

Display Control

Focus, astigmatism, spot-shift, horizontal and vertical resolution, vector filter phase adjustments are discussed here as well as graticule, character, and sweep intensity levels.

Measurement

The measurement menus (Counter/Timer, Cursors, and Measure) are presented here. "Counter/Timer Concepts" discusses the principles of using the counter/timer.

Numeric Entry

Numeric entry is accomplished through the Numeric Entry major menu. This provides a means to directly enter a value instead of turning a knob or to compute simple algebraic expressions.

Store and Recall (Instrument Settings)

Store and recall discusses the menu operations required to store, recall, or erase settings in the Store and Recall major menu, and how to access randomly or sequentially stored information.

Utilities

Here is instruction for this collection of "utility" menus: Autoset, Beep, Cal, Cal Sig, Ext Text, GPIB, Init, I/O Bnc, Probe Cal, Probe ID, Probe Skew, RS232, Test, and Time and Date.

Measurement Concept Tutorial

This subsection is a step-by-step instruction on obtaining automatic measurements, measurements using cursors, and various Counter/Tmer measurements.

Section 2

Operating Information

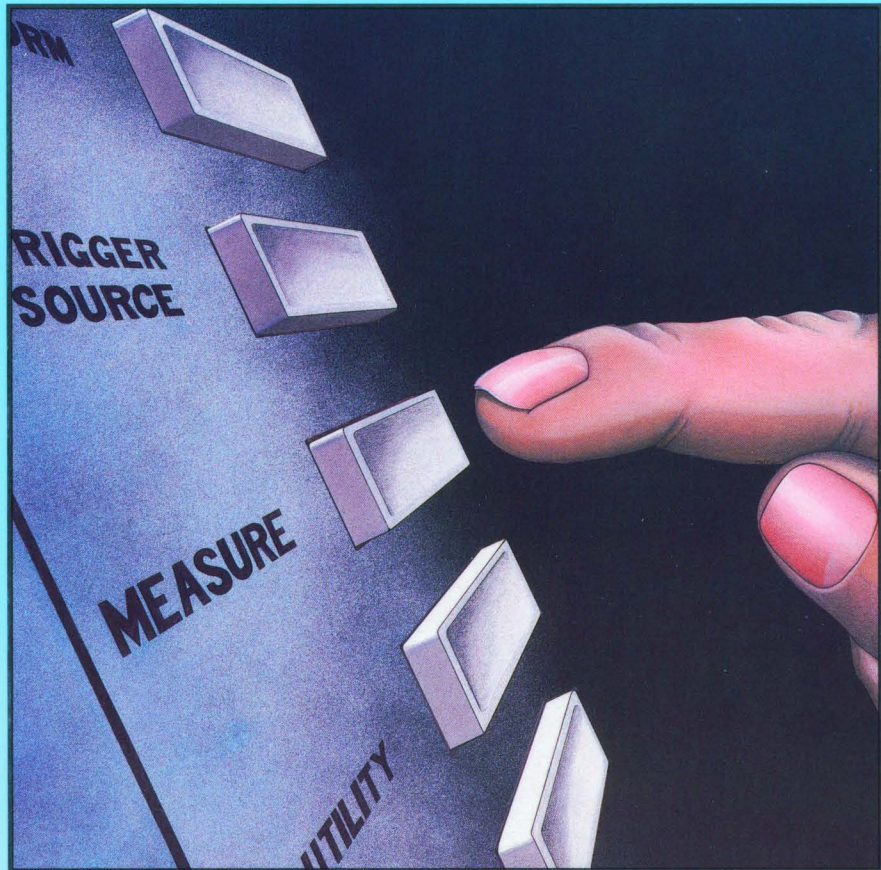

Contents

Oscilloscope Familiarization	2-1
Front-Panel Descriptions.....	2-3
Rear-Panel Descriptions.....	2-5
Buttons, Controls, Connectors, and Indicators.....	2-6
Buttons and Indicators Above The Display.....	2-6
Calibrator Connections.....	2-8
Crt Display Screen.....	2-9
Knobs and Control-Menu Buttons.....	2-10
Knobs.....	2-10
Control-Menu Buttons.....	2-10
Major Menu Buttons.....	2-13
Plug-In Compartments.....	2-15
Rear- and Front-Panel External Connections.....	2-15
Front-Panel Connectors.....	2-15
Rear-Panel Connectors.....	2-16
RS232C and IEEE-488 (GPIB) Interface Connectors.....	2-19
Switches for Power (On/Standby and Principal Power Switch).....	2-20
Power-Up Information.....	2-22
Instrument Verification.....	2-22
Calibration.....	2-22
Diagnostics.....	2-25
Self-Test.....	2-25
GPIB and RS-232-C.....	2-26
UTILITY Menu.....	2-26
Power On.....	2-26
Self-test Not at Power On.....	2-26
Oscilloscope Initialization.....	2-27
Display Area	2-31
Control Menus.....	2-32
Access to Control Menus.....	2-32
Knobs.....	2-36
Major Menus.....	2-37
Numeric Displays.....	2-37
Prompt and Message Areas.....	2-37
Touch Panel.....	2-38
Waveform Display.....	2-38
Waveform Acquisition	2-39
Acquiring Waveforms.....	2-39
Acquiring a Trace using the Display On/Off Button.....	2-39
Acquiring a Trace with the Probe ID Button.....	2-39
Autoset.....	2-40
Autoset Operation.....	2-40
AUTOSSET Button.....	2-41
Probe ID Button.....	2-42
Interactions with other Functions.....	2-42
Menu Selections.....	2-44
More Autoset Information.....	2-44

Beam Find.....	2-45
Delayed Windows ("Delayed Sweeps").....	2-46
Creating Windows and Intensified Zones.....	2-46
Delay Readout.....	2-47
Delayed Window Restrictions.....	2-48
Selecting Traces.....	2-49
Horizontal Menu.....	2-50
Access to Control Menus.....	2-50
Horizontal Position and Size Menu and Delay (Offset) Menu.....	2-50
Delay Menu.....	2-50
Time-Base Selection.....	2-52
XY Traces.....	2-54
YT Traces.....	2-55
Knob Behavior.....	2-55
Delay and Offset.....	2-55
Horizontal Position.....	2-56
Horizontal Size.....	2-56
X Offset for XY TRaces.....	2-56
Input Channel Selection (Using Probe ID).....	2-57
Probe ID (Summary of Uses and Functions).....	2-60
Create New Traces.....	2-61
Function Compatibility.....	2-61
Identify Channels in the Display and Trace Selection.....	2-61
Initiate Autoset.....	2-61
Initiate Measurements.....	2-62
Manually Generate a Service Request.....	2-62
Sequentially Recalled Stored Settings.....	2-62
Trace Selection.....	2-63
Vertical Menu.....	2-65
Access to Control Menus.....	2-65
Vertical Size, Position, and Offset Menu.....	2-65
Knob Behavior.....	2-65
Vertical Offset.....	2-66
Vertical Position.....	2-66
Vertical Size.....	2-66
Waveform Menu.....	2-67
Behavior of the Waveform Menu.....	2-67
Defining a New Trace with the WAVEFORM Menu.....	2-67
Counter View.....	2-68
Reference.....	2-69
Scope.....	2-70
General Trace Behavior.....	2-70
Display of Simple YT Traces.....	2-72
Composite YT Traces.....	2-72
Restrictions for Composite Traces.....	2-74
XY Traces.....	2-75
XY Trace Restrictions.....	2-75
Inverting Channel Polarity.....	2-76

Triggering	2-77
Trigger Holdoff Menu.....	2-77
Holdoff Menu Selections.....	2-77
Knob Behavior when using Holdoff.....	2-80
Restrictions for Holdoff.....	2-80
Restrictions for Holdoff by Events.....	2-81
Trigger Level Menu.....	2-83
Menu Selections.....	2-83
Menu Selection Definitions.....	2-84
Trigger Level Knob Behavior.....	2-86
Trigger Scaling.....	2-86
Trigger Source Major Menu.....	2-88
About Defining Trigger Sources.....	2-88
Choices of Trigger Sources.....	2-90
Creating Trigger Source Expressions for Main and Delayed Triggers.....	2-91
Trigger Source Restrictions.....	2-91
Expressions for Composite Triggers for Main and Delayed Triggers.....	2-92
Composite Trigger Restrictions.....	2-92
Inverting Channel Polarity.....	2-93
Pending Source Definition.....	2-93
Single (Sequence) and Trigger Reset.....	2-93
Single sequence.....	2-93
Trigger RESET.....	2-94
Trigger After Delay.....	2-95
Display Control	2-97
Display Adjust Major Menu.....	2-97
DISP ADJ Menu Knob Behavior.....	2-101
Intensity.....	2-102
11302 Intensity Behavior.....	2-102
Complete Shutdown.....	2-102
Partial Shutdown.....	2-103
INTENSITY Knob Behavior.....	2-103
Measurement	2-105
Counter/Timer.....	2-105
Counter/Timer Controls and Functions.....	2-105
Averaging.....	2-105
Count Ref.....	2-105
Counter Source Selection.....	2-105
Restrictions and Interactions.....	2-106
Gating.....	2-107
Measure.....	2-107
Frequency.....	2-107
Off.....	2-109
Period.....	2-110
Ratio.....	2-111

Time A→B.....	2-112
A & B External Source.....	2-112
Main and Delayed Trigger Source.....	2-113
Swp Start.....	2-114
Total.....	2-117
Width.....	2-118
Updating.....	2-119
Counter/Timer Knob Assignments.....	2-120
Counter/Timer Operation.....	2-122
Additional Control and Status.....	2-126
Counter View Traces.....	2-127
Presentation of Results.....	2-130
Frequency, Period, Ratio, Time, and Width.....	2-130
Total.....	2-131
Ratio.....	2-131
Counter/Timer Concepts.....	2-132
Description.....	2-132
Counter View Display.....	2-132
Displaying Counter View Traces.....	2-132
Measured Signals.....	2-134
Measurement Intervals.....	2-135
Frequency Measurements.....	2-136
Gated Frequency Measurements.....	2-137
Input Coupling, Noise, and Attenuation.....	2-138
Nulling the Counter/Timer.....	2-140
Reducing Measurement Errors.....	2-140
Time Interval Measurements.....	2-141
Cursors.....	2-143
Cursors Menu.....	2-143
Cursors Selected For Horizontal.....	2-143
Cursors Selected for Vertical.....	2-145
Cursors When Off.....	2-146
Tracking and Nontracking Cursors.....	2-146
Set Ref.....	2-146
Scaling.....	2-147
Knob Behavior.....	2-148
Horizontal Cursors.....	2-148
Vertical cursors.....	2-148
Restrictions.....	2-148
Measure Menu.....	2-149
Numeric Entry.....	2-153
Choices of Left or Right Knob.....	2-155
Count Reference.....	2-156
Functioning as a Calculator.....	2-156
Operation.....	2-156
Initial Conditions.....	2-157

Store and Recall (Instrument Settings)	2-159
Menu Behavior.....	2-159
Operation.....	2-160
Operator's Procedure.....	2-161
Utilities	2-163
Autoset.....	2-164
Beep.....	2-165
Calibration.....	2-166
Calibrator Signal (Front-Panel Output).....	2-167
Extended Test.....	2-168
GPIB (IEEE-488).....	2-169
Initialize.....	2-171
Input and Output BNC Control.....	2-172
Probe Cal.....	2-173
Probe ID.....	2-174
Probe Skew.....	2-175
RS-232-C Selections.....	2-176
Test.....	2-177
Time and Date Selections.....	2-178
Measurement Concept Tutorial	2-179
Coaxial Cables and Probes.....	2-179
Coaxial Cables.....	2-179
Probes.....	2-179
Measurement Examples.....	2-180
Automatic Measurements.....	2-180
Cursors Measurements.....	2-182
Peak to Peak Measurements.....	2-182
Phase Measurements.....	2-184
Rise Time Measurements.....	2-187
Counter/Timer Measurements.....	2-192
Basic Frequency Measurements.....	2-192
Counter View Traces.....	2-193
Gated Frequency Measurements.....	2-195
Nulling the Counter/Timer.....	2-199
Time Interval Measurement of Propagation Delay.....	2-200

Operating Information

Section 2 contains all the information you need to operate either the 11301 or the 11302 Programmable Oscilloscope. The main headings of this section are broken into eleven functional parts listed in a logical order of use:

- Oscilloscope Familiarization
- Display Area
- Waveform Acquisition
- Triggering
- Display Control
- Measurement
- Numeric Entry
- Store and Recall
- Utilities
- Measurement Concept Tutorial

To facilitate quick access to information, a dictionary-like form is used. Notice in the contents of this section, each item listed below the main heading is in alphabetical order. The reason for this is that beyond the major heading each user's application may change the logical order of use.

To easily distinguish menu functions from menu function choices directly referred to within the text, menu functions will be printed in medium text and menu function choices will be printed in **bold** text.

Upper-case words refer to buttons, controls, connectors, or indicators marked on the front- and rear-panels of the oscilloscope. Initial upper-case words are unmarked controls (e.g., Control knobs, Probe ID button, and Camera Power connector).

Oscilloscope Familiarization

This section, "Oscilloscope Familiarization," is intended to familiarize you with the front and rear panels of the oscilloscope.

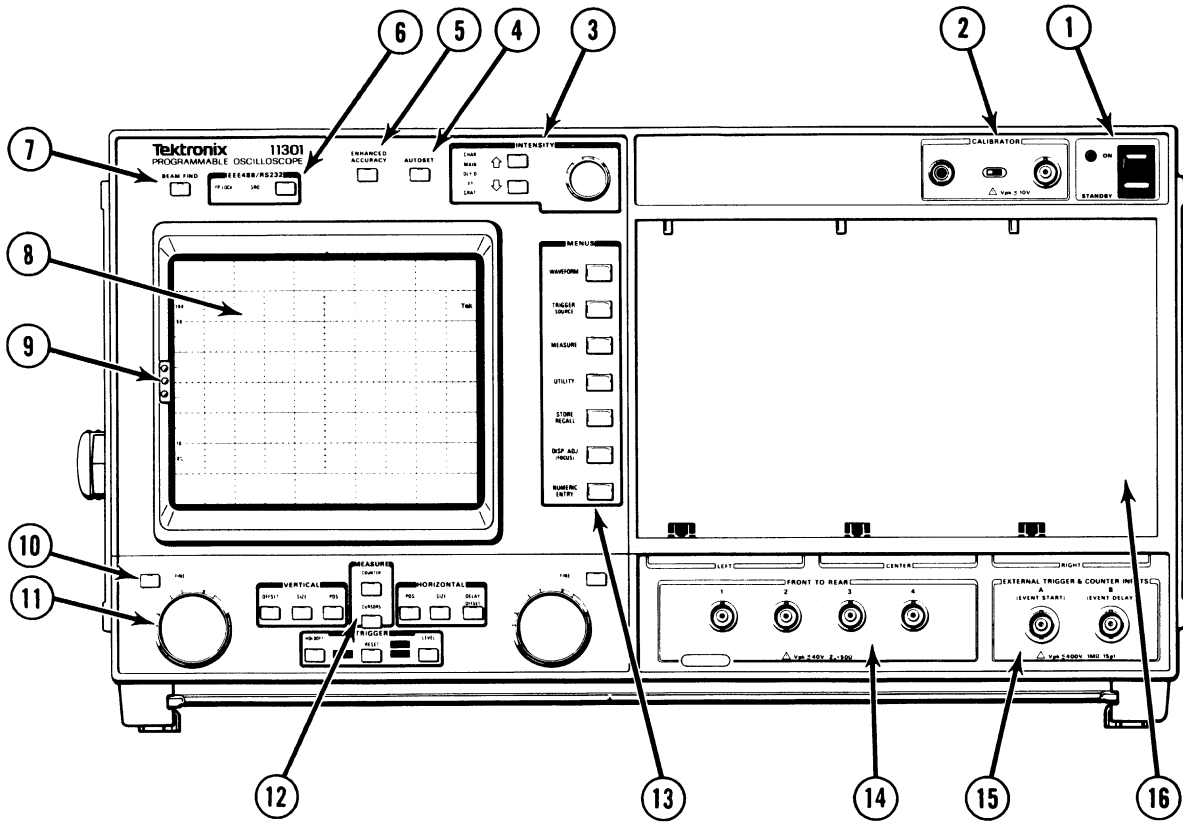

Figure 2-1. Front-panel controls, connectors, and indicators.

Front-Panel Descriptions

- ① **ON/STANDBY**—Applies dc power to entire oscilloscope.
- ② **CALIBRATOR Connector and Probe-tip Jack**—Provides a signal for calibrating probes and serves as a simple signal source.
- ③ **INTENSITY**—Controls brightness of selected trace, graticule, or characters.
- ④ **AUTOSET Button**—Gives a one time automatic scaling of vertical and horizontal deflection and triggering.
- ⑤ **ENHANCED ACCURACY Button**—Gives a one time self-calibration.
- ⑥ **IEEE488/RS232**—Pressing the SRQ button produces an interrupt. FP LOCKED, when backlighted, indicates a programmed nonoperating front panel.
- ⑦ **BEAM FIND Button**—When pressed, compresses the display within the graticule area.
- ⑧ **Crt with Touch Screen**—Display and touch selection area.
- ⑨ **Camera Power Connector (not labeled)**—Power for camera.
- ⑩ **FINE Button**—Gives "fine" increment adjustment for knobs.
- ⑪ **Knobs (not labeled)**—Performs selections chosen by pressing control-menu buttons.
- ⑫ **Control Menu Buttons**—When pressed, invoke respectively VERTICAL OFFSET, SIZE, and POSition; COUNTER; CURSORS; TRIGGER HOLDOFF; TRIGGER LEVEL; HORIZONTAL SIZE and POSition; and HORIZONTAL DELAY Knob menus. Also here is the TRIGGER RESET button and READY, D TRIG, and M TRIG indicators.
- ⑬ **Major Menu Buttons**—When pressed, these invoke respectively WAVEFORM, TRIGGER SOURCE, MEASURE, UTILITY, STORE/RECALL, DISP ADJ (FOCUS), and NUMERIC ENTRY major menus.
- ⑭ **FRONT TO REAR Connectors**—Allow input to the amplifiers through the instrument from the rear panel.
- ⑮ **A and B EXTERNAL COUNTER TRIGGER & INPUT Connectors**—Used for input to the Counter Timer and to the main and delayed triggers.
- ⑯ **Plug-in Compartments**—LEFT, CENTER, and RIGHT compartments for inserting plug-ins.

6106-201B

Figure 2-1 (cont). Front-panel controls, connectors, and indicators.

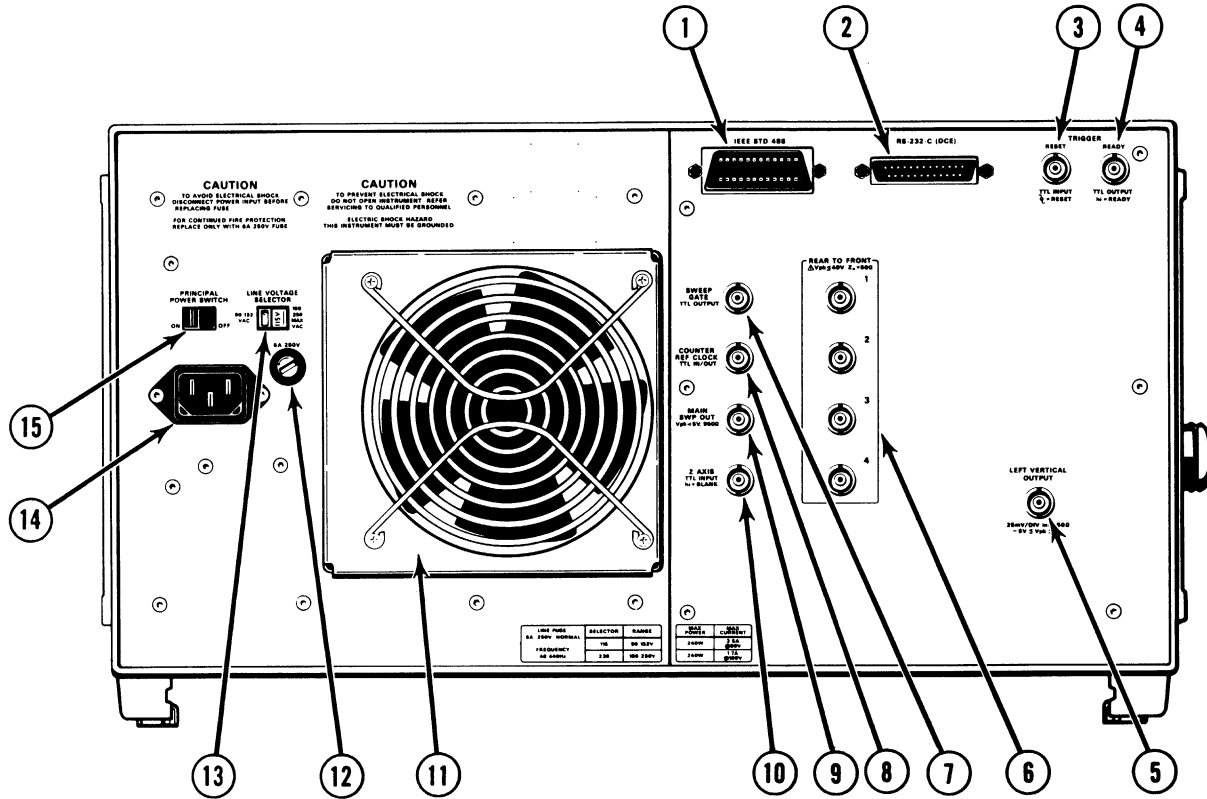

6106-202A

Figure 2-2. Rear-panel controls, connectors, and indicators.

Rear-Panel Descriptions

- ① **IEEE STD 488 Connector**—Interface connector for GPIB.
- ② **RS-232-C (DCE) Connector**—Interface connector for RS-232.
- ③ **TRIGGER RESET Connector**—Aborts and arms the Counter Timer measurements and the sweeps that are in progress.
- ④ **TRIGGER READY Connector**—Outputs a signal from the LEFT plug-in compartment.
- ⑤ **LEFT VERTICAL OUTPUT**—Outputs a signal from the LEFT plug-in compartment.
- ⑥ **REAR TO FRONT Connectors**—Allow input to the amplifiers through the instrument to the front panel.
- ⑦ **SWEEP GATE OUTPUT**—Signal derived from the Main or Delayed sweep gates as selected from the UTILITY menu (I/O BNC).
- ⑧ **COUNTER REF CLOCK**—Connects a cable for a reference into or out of the Counter as selected from the UTILITY menu (I/O BNC).
- ⑨ **MAIN SWEEP OUT**—Signal (sawtooth) derived from the Main time base.
- ⑩ **Z AXIS INPUT**—External control for intensity modulation of the display.
- ⑪ **Fan**—Variable speed, depending upon temperature, exhausting fan.
- ⑫ **Fuse Holder**—Contains the ac power source fuse.
- ⑬ **LINE VOLTAGE SELECTOR Switch**—Selects the nominal instrument operating voltage range.
- ⑭ **Receptacle for Detachable Power Cord**—Provides connection for the ac power source to the instrument.
- ⑮ **PRINCIPAL POWER SWITCH**—Ac power switch.

Figure 2-2 (cont). Rear-panel controls, connectors, and indicators.

Buttons, Controls, Connectors, and Indicators

The following description shows you the location and function of the controls, connectors, and indicators of the oscilloscope.

Buttons and Indicators Above The Display

Refer to Figure 2-1, Front-panel controls, connectors, and indicators, and Figures 2-3 and 2-4.

The BEAM FIND button, when held in, compresses the display to within the graticule area. Observing where the waveform appears gives you a clue to the direction the controls must be adjusted to bring the waveform on-screen.

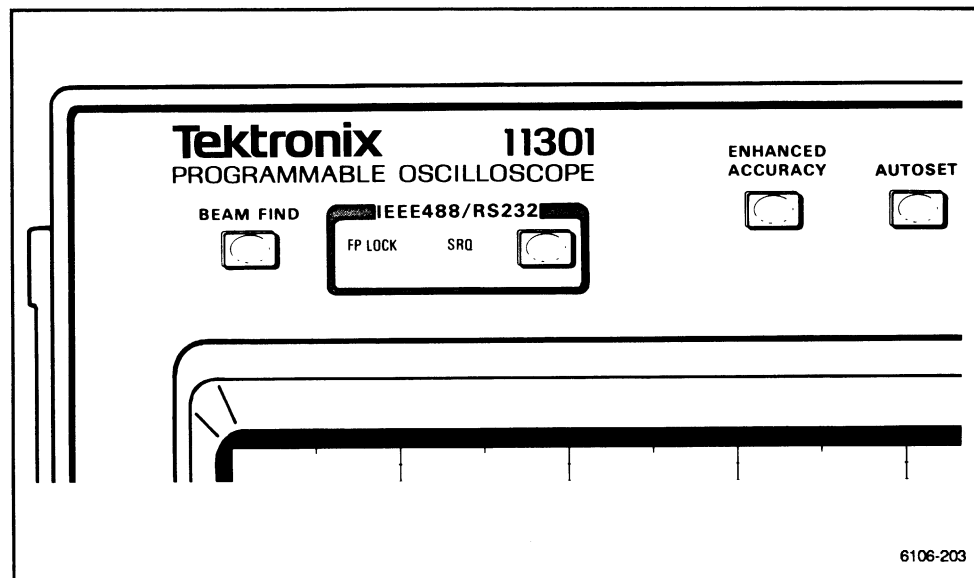

Figure 2-3. BEAM FIND, IEEE488/RS232, ENHANCED ACCURACY, and AUTOSET buttons.

This instrument is IEEE-488 (GPIB) and RS-232-C compatible. An interrupt can be generated, if programmed to do so, by pressing the SRQ button. SRQ will be backlit while any interrupt is posted. It will be extinguished after the GPIB has serviced or cleared all SRQs.

FP LOCKED will be backlit if the front panel has been programmed to be nonoperating. This means you cannot operate the front-panel controls, except the ON/STANDBY switch, when this light is illuminated.

There is a means to electrically lock the ON/STANDBY switch in the ON position. The instrument must be referred to a qualified service person for internal setting.

Pressing the ENHANCED ACCURACY button gives a one time self-calibration. The Enhanced Accuracy will remain until the temperature varies 5° C from the self-calibrated temperature, then lapse to the Not-Enhanced Accuracy state. (See "Power-Up Information" in this subsection for more information on Enhanced Accuracy.) Enhanced Accuracy can be used 20 minutes after power has been turned on. It is especially useful prior to making a critical precision measurement.

The AUTOSET button, when pressed, initiates a one time only automatic scaling of vertical and horizontal deflection and triggering of the selected trace.

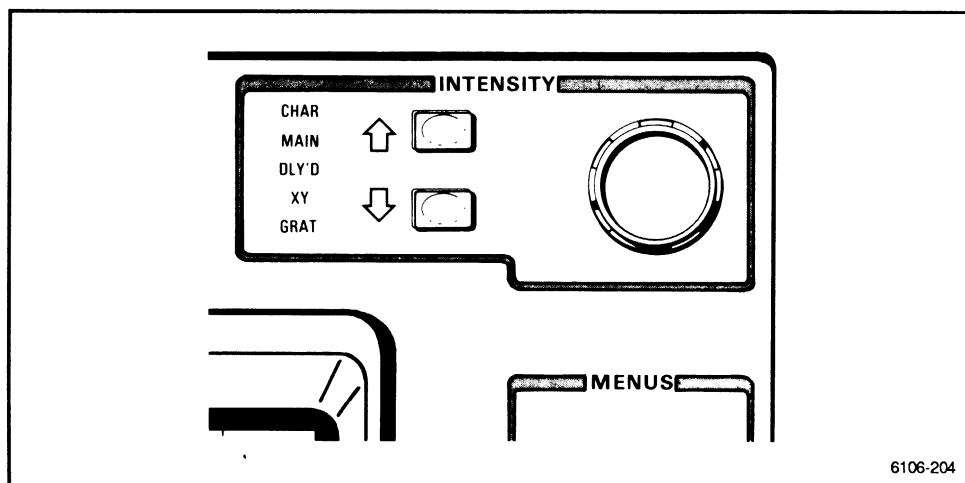

Figure 2-4. INTENSITY controls.

The INTENSITY controls include of two buttons and an adjacent knob. Pressing the upper button scrolls upward through the selections listed to the left of the buttons. The current selection is backlit. Pressing the lower button scrolls through the list in the downward direction. Rotating the knob changes the intensity of the selected item.

Calibrator Connections

Refer to Figure 2-1, Front-panel illustration, and Figure 2-5.

The CALIBRATOR area provides three connectors: a ground connection, a probe-tip jack, and a bnc connector.

NOTE

All the instruments involved during testing (especially true on sensitive measurements) should be joined using heavy cable at this ground connector. Otherwise, any difference in the ground potential of these instruments results in current flowing in the probe shield. The signal displayed will be distorted. See "Coaxial Cables and Probes" under "Measurement Concept Tutorial."

The oscilloscope has both a bnc connector and a probe-tip jack that facilitates calibration of probes; each provides the same calibration signal. The signal type, amplitude output, and repetition rate are controlled using *Cal Sig* in the UTILITY menu.

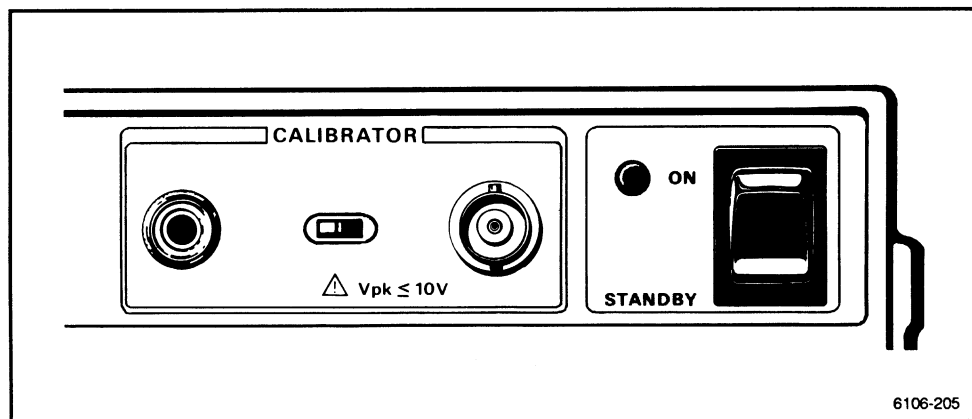

Figure 2-5. CALIBRATOR connections.

Crt Display Screen

Refer to Figure 2-1, Front-panel illustration, and Figure 2-6.

The crt is used in conjunction with a touch-screen; that is, selections can be made by touching the crt. Sometimes the crt may be referred to as "the screen" or as "the display."

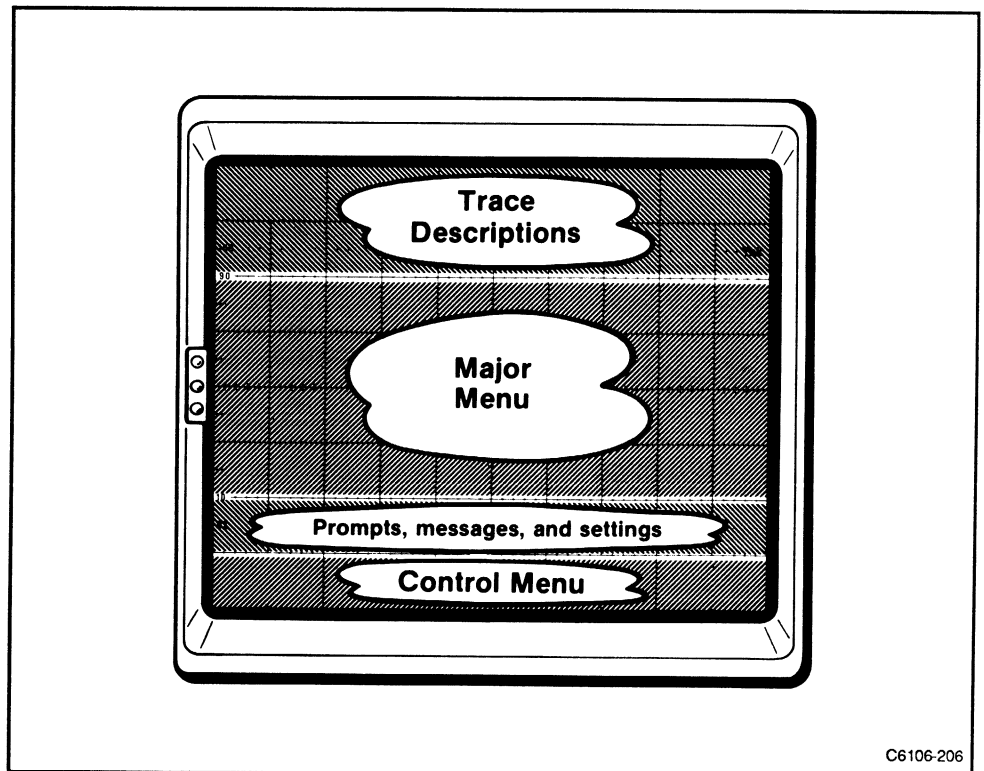

Figure 2-6. Display format.

Up to eight unique traces can be displayed. The names or descriptions of the traces occupy the area of the screen labeled "Trace Descriptions" as shown in Figure 2-6. Horizontal scaling information appears at the upper right corner. The *D Time/div* is displayed whenever the delayed time base is used. Both left and right knobs or knob controlled calculated values are displayed on the bottom third line. The oscilloscope functions that are known to interact or are believed to be convenient knob adjustments (control menus) are offered at the bottom.

The three-pin Camera Power connector (not labeled) on the left of the crt provides power for the camera and receives control signals from Tektronix automatic cameras to allow camera-controlled single-shot photography (see camera manual for complete instructions for obtaining waveform photographs).

Knobs and Control-Menu Buttons

Refer to Figure 2-1, Front-panel illustration, and Figure 2-7.

The functions that the knobs perform are selected with the control-menu buttons located below the crt.

Knobs

Below the crt are two large knobs that can be assigned to different functions by pressing one of the several adjacent buttons. A corresponding LED illuminates your choice.

Each knob can have coarse or fine increments. When the FINE button is pressed, FINE will be backlit offering small increments. When the button is pressed again, the light will no longer be illuminated and the increments will be coarse. Coarse and FINE settings are retained for different knob assignments.

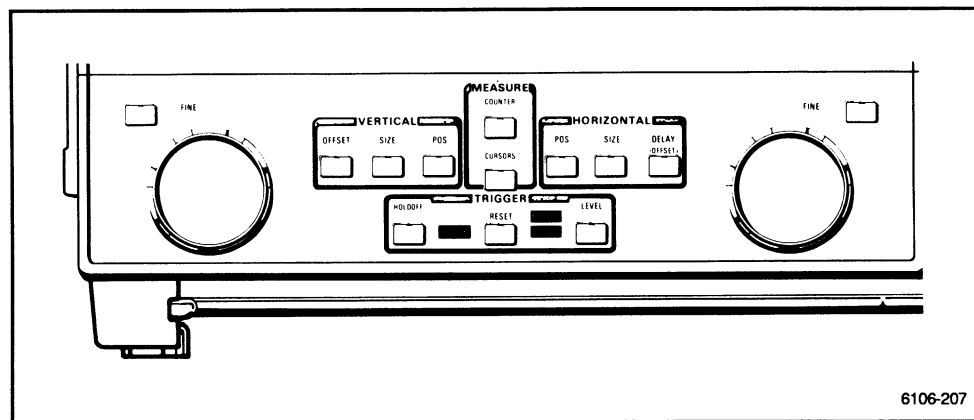

Figure 2-7. Knobs and control-menu buttons.

Refer to Figure 2-1, Front-Panel illustration, and Figure 2-8.

Control-Menu Buttons

The functions of the two knobs are selected by pressing the buttons located between them. These buttons, when pressed, invoke seven different types of control menus: VERTICAL SIZE, POS (position), or OFFSET buttons invoke the Vertical menu; HORIZONTAL POS or SIZE buttons invoke the Horizontal menu; the HORIZONTAL DELAY button invokes the Delay menu; TRIGGER HOLDOFF button invokes the Holdoff menu; the TRIGGER LEVEL button invokes the Trigger Level menu; the COUNTER button invokes the Counter/Timer menu; and CURSORS button invokes the Cursor menu.

Pressing a control-menu button once displays the corresponding menu and lets you change the selected parameter by turning a knob. (Notice that the left knob controls the Vertical selections and the right knob controls the Horizontal selections.) Pressing the control-menu button a second time removes the control menu from the screen. A third press returns the control menu to the original position on the display.

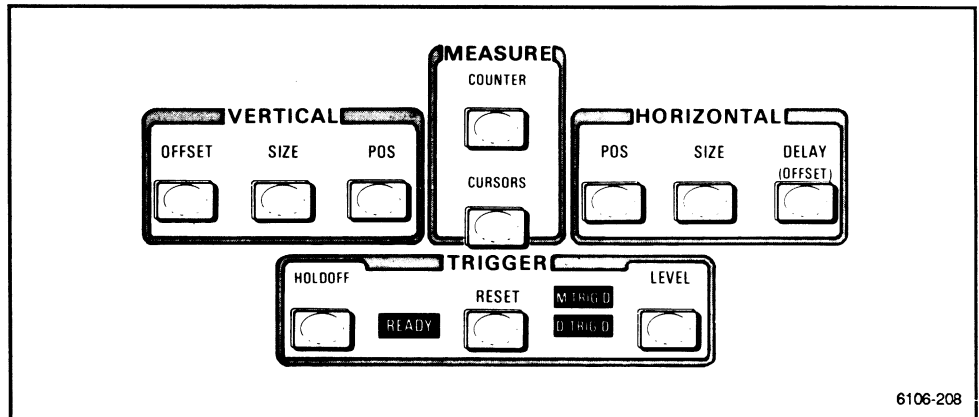

Figure 2-8. Control-menu buttons.

Pressing the VERTICAL OFFSET button assigns the left knob to controlling input offset within the amplifier. Other menu choices (e.g., *Coupling*, *Impedance*, etc.), dependent on the installed amplifier, are accessible.

Pressing the VERTICAL POSition button enables the left knob to move the trace upward or downward on the screen. Other menu choices (e.g., *Coupling*, *Impedance*, etc.), dependent on the installed amplifier, are accessible.

Pressing the VERTICAL SIZE button displays the vertical menu and assigns the left knob to vertical input sensitivity. Other menu choices (e.g., *Coupling*, *Impedance* etc.), dependent on the installed amplifier, are accessible.

Pressing the HORIZONTAL POSition button displays the Horizontal Control menu and enables the right knob to move the trace left or right on the screen.

Pressing the HORIZONTAL SIZE button displays the horizontal menu and assigns the right knob to control the time per division (*Time/div*) or horizontal sensitivity for XY traces. Turning the knob clockwise increases the sweep speed (lowers *Time/div*).

Pressing the HORIZONTAL DELAY button displays the Delay menu and assigns the knob to control the delay value of the delayed windows or the horizontal offset for an XY trace. Delay sweeps (windows) are created using this control menu.

Refer to Figure 2-1, Front-panel illustration, and Figure 2-9.

The MEASURE functions, COUNTER and CURSORS, display menus when their respective buttons are pressed. These menus are accessed similarly to the Vertical and Horizontal functions. Press either function and a corresponding control menu appears: one press displays the control menu, a second press removes the control menu from the screen, and a third press displays the menu again.

Pressing the COUNTER button displays the Counter menu while maintaining the previous knob assignments. No new functions are assigned to either knob. Counter selections are made on the touch screen.

The CURSORS button, when pressed, assigns both knobs to respective cursors. A Cursor menu is displayed allowing several cursor choices. Horizontal cursors are vertical lines marking a horizontal measurement. Vertical cursors are horizontal lines marking a vertical measurement.

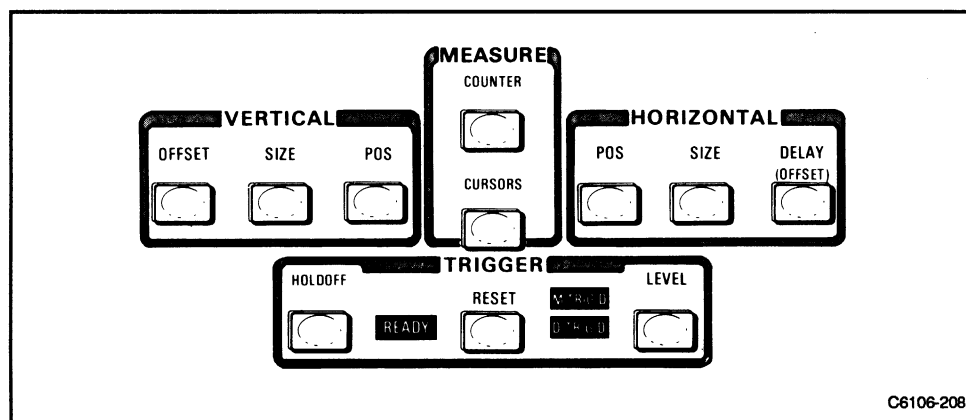

Figure 2-9. Control-menu buttons.

Pressing the TRIGGER HOLDOFF button allows you to use the left knob to vary the holdoff period (time between Main time-base triggers) to improve the triggering stability of repetitive complex waveforms. *Holdoff* can also be by **2ns Step, Countdown, or Events**.

Pressing the TRIGGER RESET button aborts the sweeps and Counter/Timer activity and then arms the trigger sweeps and Counter/Timer. When armed by the TRIGGER RESET button, the READY light will indicate an armed condition.

Pressing the TRIGGER LEVEL button displays the Trigger control menu and enables the right knob so that you may select a level on the trigger signal where triggering occurs.

Triggered indicators for Main (M Trig) and Delayed (D Trig) are illuminated when the respective trigger conditions (slope, level, etc.) detect a signal transition.

Major Menu Buttons

Refer to Figure 2-1, Front-panel illustration, and Figure 2-10.

Seven major menu buttons provide a direct path to major menus **independent** of previous selections. That is, any major menu can be accessed at random.

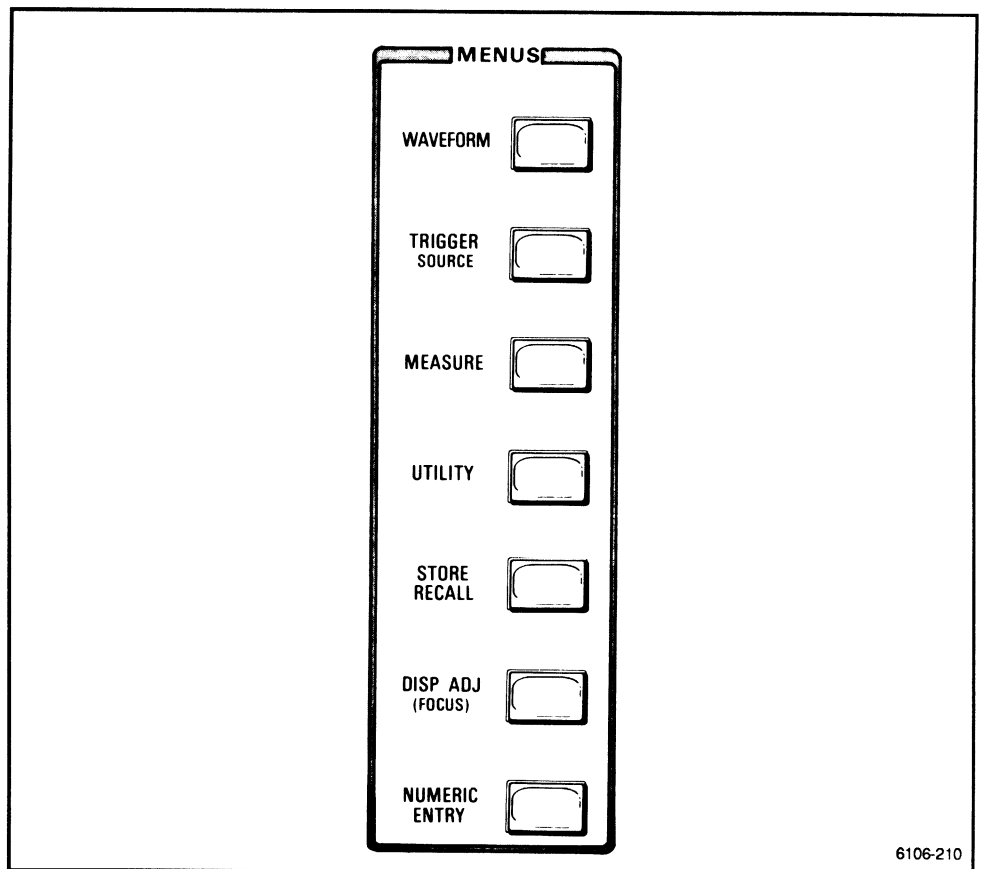

Figure 2-10. Major-menu buttons.

The **WAVEFORM** major menu is used to construct more complex waveforms using operators such as **+**, **-**, and **Vs** (versus). Counter/Timer signals (counter-views) can also be displayed. See the "Waveform Acquisition" subsection for detail.

The **TRIGGER SOURCE** major menu allows you to select the input signals that you wish to trigger on. Sources for the Main and Delayed (window) time bases are defined here. See the "Triggering" subsection for detail.

The **MEASURE** major menu is used to obtain a variety of waveform measurements. Automatic measurement of time and amplitude characteristics of a waveform can be made. See the "Measurement" subsection for detail.

Refer to Figure 2-1, Front-panel illustration, and Figure 2-11.

The UTILITY major menu gives access to these miscellaneous settings: Autoset, Beep (audio level), Calibration, Calibration Signal, Extended Testing, GPIB (IEEE-488) Interface, Initialize, defining Input/Output Bnc's, Probe Cal, Probe ID, Probe Skew, RS-232 Interface, Test (self-test), and setting the Time and Date. See the "Utilities" subsection for detail.

The STORE RECALL major menu allows the storing of instrument settings for recall at a later time. See the "Store and Recall" subsection for detail.

The DISP ADJ major menu accesses various special display patterns as well as controls for Focus, Astigmatism, and Trace Rotation. Contrast of the intensified zones and control of background shading of characters are controlled through selections of Δ Main and Δ Char respectively. Before other knob assignments can be made, this menu must be turned off. See the "Display Control" subsection for detail.

The NUMERIC ENTRY major menu allows you to change a setting in lieu of using a control menu, to specify a reference value for difference (delta) measurements when using the Counter/Timer, and to compute simple algebraic expressions. See the "Numeric Entry" subsection for detail.

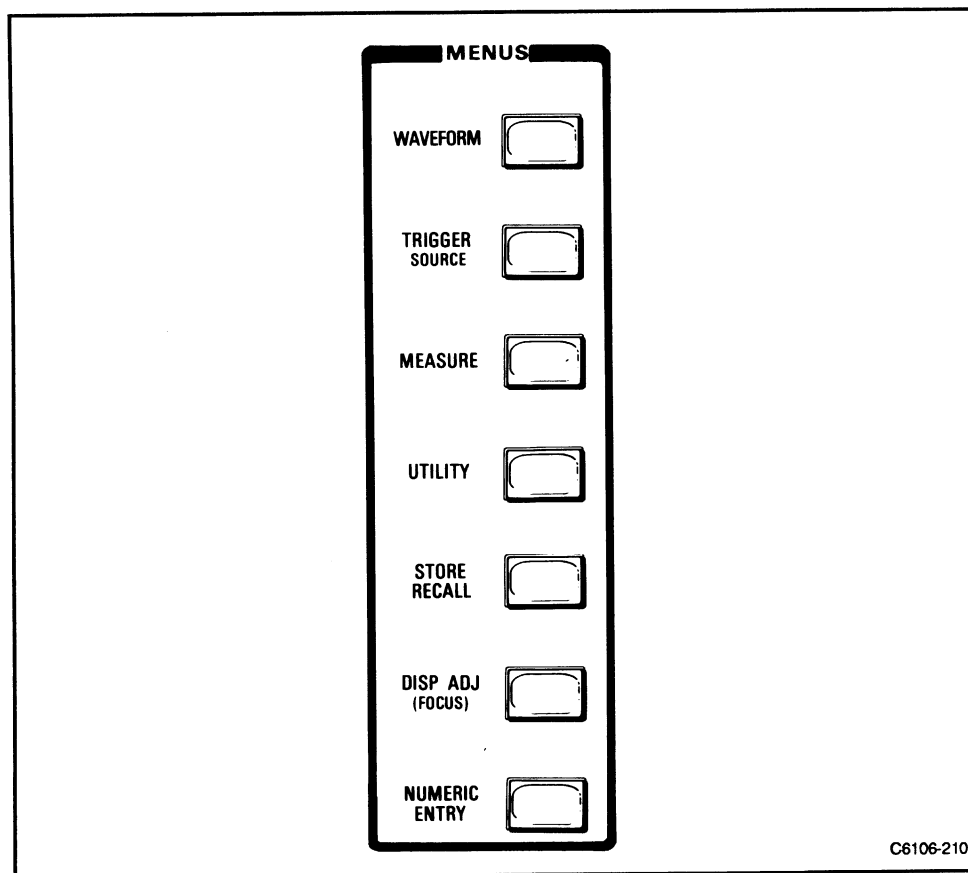

Figure 2-11. Major-menu buttons.

Plug-In Compartments

Refer to Figure 2-1, Front-panel illustration.

The three plug-in compartments are LEFT, CENTER, and RIGHT. The LEFT compartment can be used for vertical deflection only. The CENTER compartment can be used for either vertical or horizontal deflection. The RIGHT compartment can be used for horizontal deflection only. Any compartment can be used for a trigger source or other special purpose plug-in.

Rear- and Front-Panel External Connections

A number of external connections reside on the front and rear panel of the oscilloscope. The EXTERNAL A and B TRIGGER & COUNTER INPUT bnc connectors are on the lower right corner.

On the lower right front are four bnc FRONT TO REAR connectors. These connections are fed through the instrument to the matching set of REAR TO FRONT bnc connectors. (An optional set of eight connectors is available, see Section 5, "Instrument Options.")

On the rear of the instrument there is a IEEE-488 (GPIB) and a RS-232-C (DCE) connector as well as four other signal connectors (SWEEP GATE, COUNTER REF CLOCK, MAIN SWEEP OUTPUT, and Z-AXIS).

Front-Panel Connectors

Refer to Figure 2-1, Front-panel illustration, and Figure 2-12.

Beneath the plug-in compartments are several bnc type connectors. The first two, on the lower right, can be used for input to the Counter/Timer and to the main and delayed triggers.

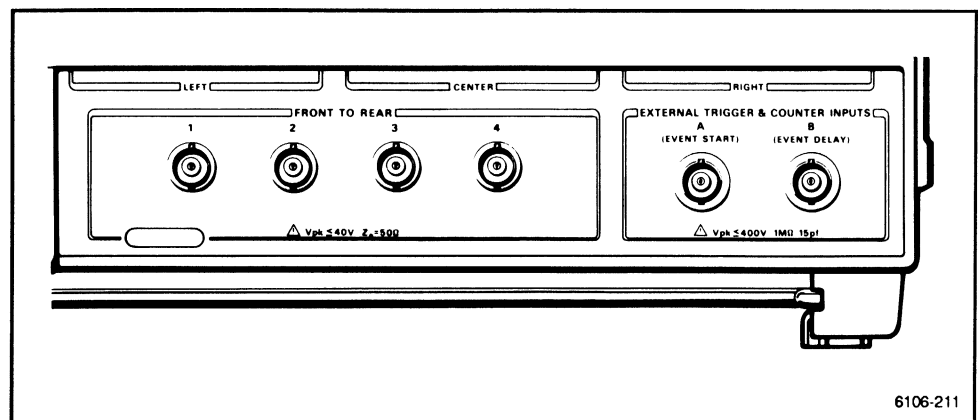

Figure 2-12. Front-panel external connectors.

The FRONT TO REAR bnc connectors allow input to the plug-in amplifiers through the instrument from the rear panel. These are 50Ω impedance coaxial cables.

Rear-Panel Connectors

Refer to Figure 2-2, Rear-panel illustration, and Figure 2-13.

The SWEEP GATE OUTPUT provides a signal derived from the Main or Delayed sweep gates as selected from *I/O Bnc* function choice in the UTILITY menu.

The COUNTER REF CLOCK allows a 10 MHz reference to be connected into or out of the Counter as selected from the *I/O Bnc* function choice in the UTILITY menu.

The MAIN SWEEP OUTPUT is a sawtooth signal derived from the Main time base.

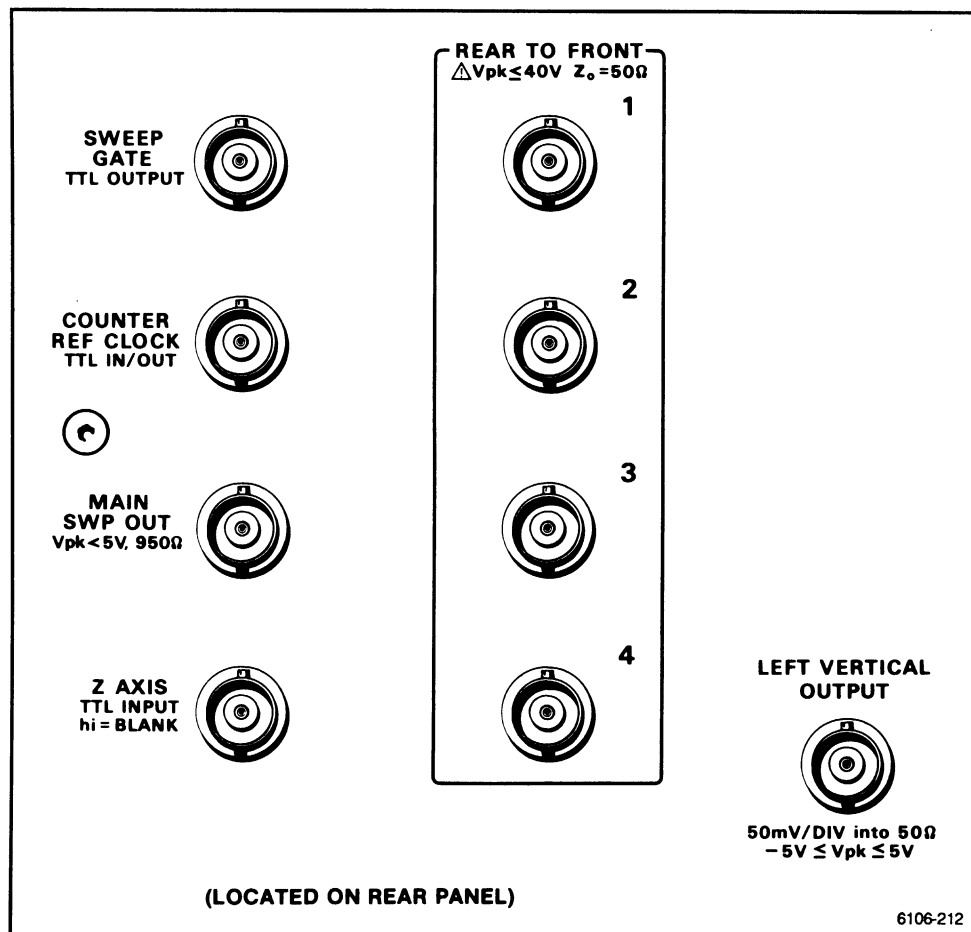

Figure 2-13. REAR TO FRONT and signal-controlling input/output connectors.

The Z-AXIS INPUT is an external control for intensity modulation of the display.

The four (eight optional) bnc REAR TO FRONT connectors correspond to the four connectors on the front-panel. These are a direct feedthrough for convenience.

LEFT VERTICAL OUTPUT is an output signal from the LEFT compartment trigger signal.

Refer to Figure 2-2, Rear-panel illustration, and Figure 2-14.

The TRIGGER RESET input bnc connection allows you to abort and arm the Counter/Timer measurements and sweeps in progress on a high to low transition.

The TRIGGER READY output bnc connector signals when the Counter/Timer and sweeps have been armed by the TRIGGER RESET signal or front-panel button.

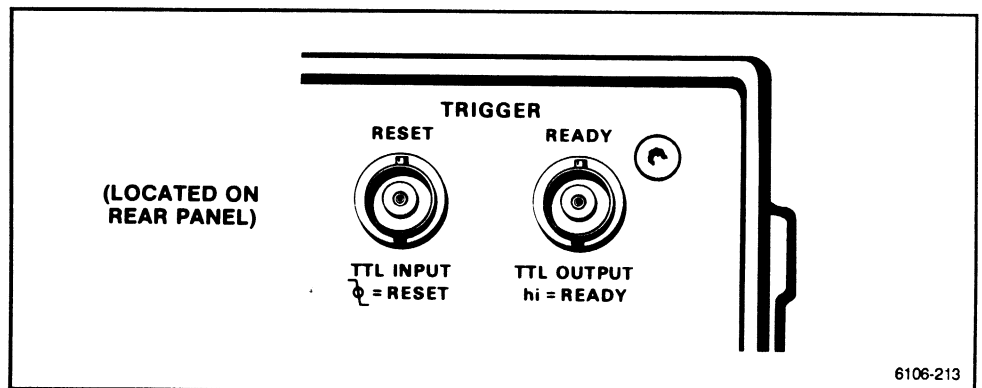

Figure 2-14. TRIGGER RESET and READY connectors.

Refer to Figure 2-2, Rear-panel illustration, and Figure 2-15.

The fan, the socket for the detachable line cord, the PRINCIPAL POWER SWITCH, the fuse, and the indicator that shows the selected line voltage are on the rear of the instrument.

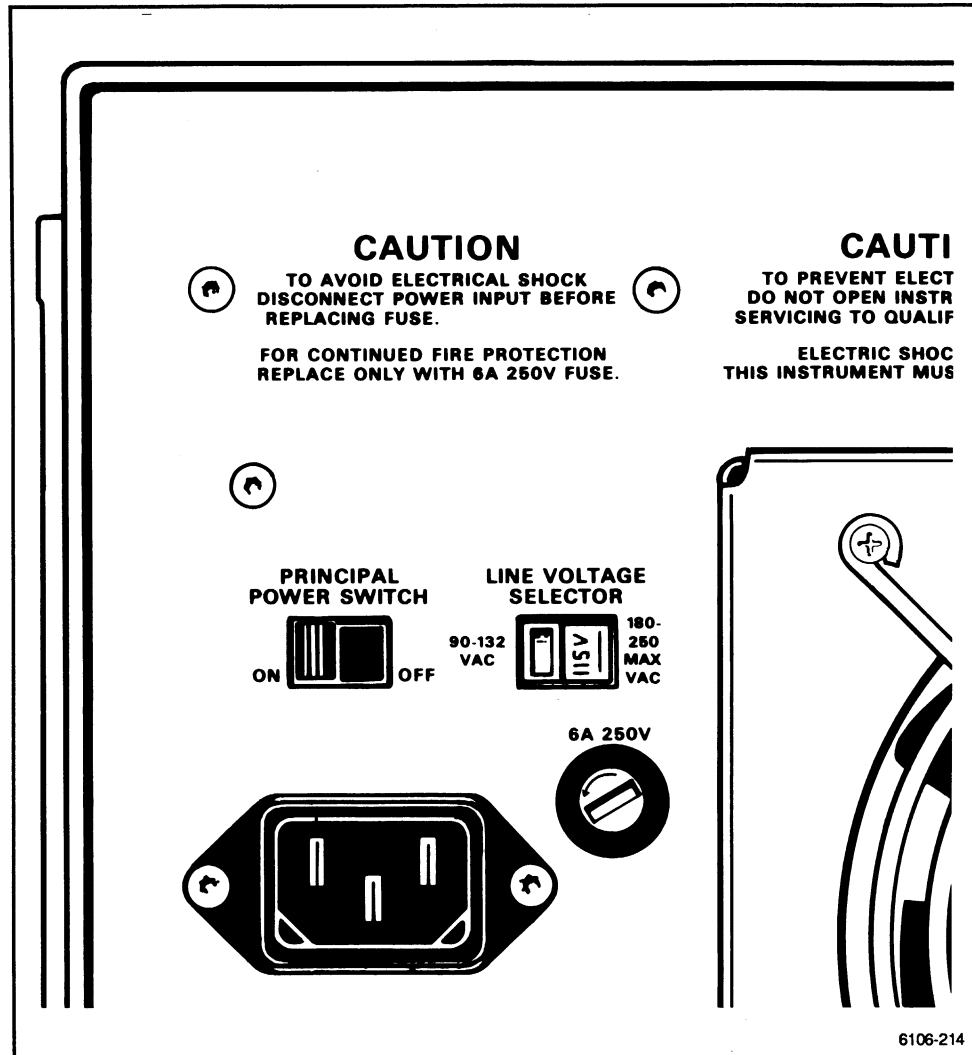

Figure 2-15 Fan, line cord socket, PRINCIPAL POWER SWITCH, fuse, and LINE VOLTAGE SELECTOR.

The fan is a variable speed, temperature-dependent, exhaust fan. The detachable power cord receptacle provides connection for the ac power source. The PRINCIPAL POWER SWITCH is the main ac power switch. The Fuse Holder contains the ac power source fuse, and the LINE VOLTAGE SELECTOR switch selects the nominal instrument operating voltage range.

RS232C and IEEE488 (GPIB) Interface Connectors

Refer to Figure 2-2, Rear-panel illustration, and Figure 2-16.

This oscilloscope interfaces with either GPIB (IEEE488) or RS-232-C instruments. These are respectively 24 pin female and 25 pin female connectors on the rear of the instrument. Please refer to "Utility" in this section for operating parameters, and refer to Section 3, "GPIB/RS-232-C Interfaces" in this manual for operation, programming, syntax, and command language.

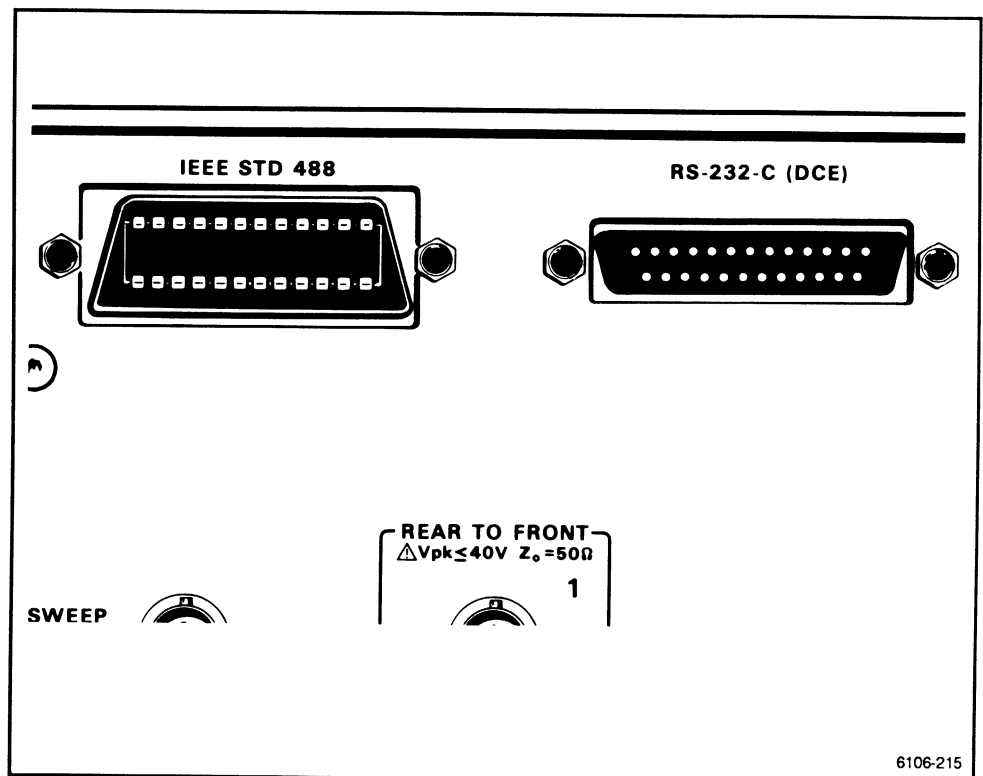

Figure 2-16. IEEE-488 (GPIB), and RS-232-C interface connectors.

Switches for Power (On/Standby and Principal Power Switch)

Refer to Figures 2-1 and 2-2, Front- and Rear-panel illustrations, and Figure 2-17.

The PRINCIPAL POWER SWITCH, which is located on the rear of the instrument, is the main power switch. The ON/STANDBY switch energizes the instrument. An indicator next to the ON/STANDBY switch illuminates when the rear power switch is in the ON position and the ON/STANDBY switch is in the ON position. (If Option 1T is installed, it will remain powered while in STANDBY).

As soon as both the PRINCIPAL POWER SWITCH and the front-panel ON/STANDBY switch are ON, a self test will verify the instrument functionality. This test can also be invoked from a menu (see "Test" under "Instrument Verification").

To electrically lock the ON/STANDBY switch in the ON position, refer the instrument to qualified service personnel.

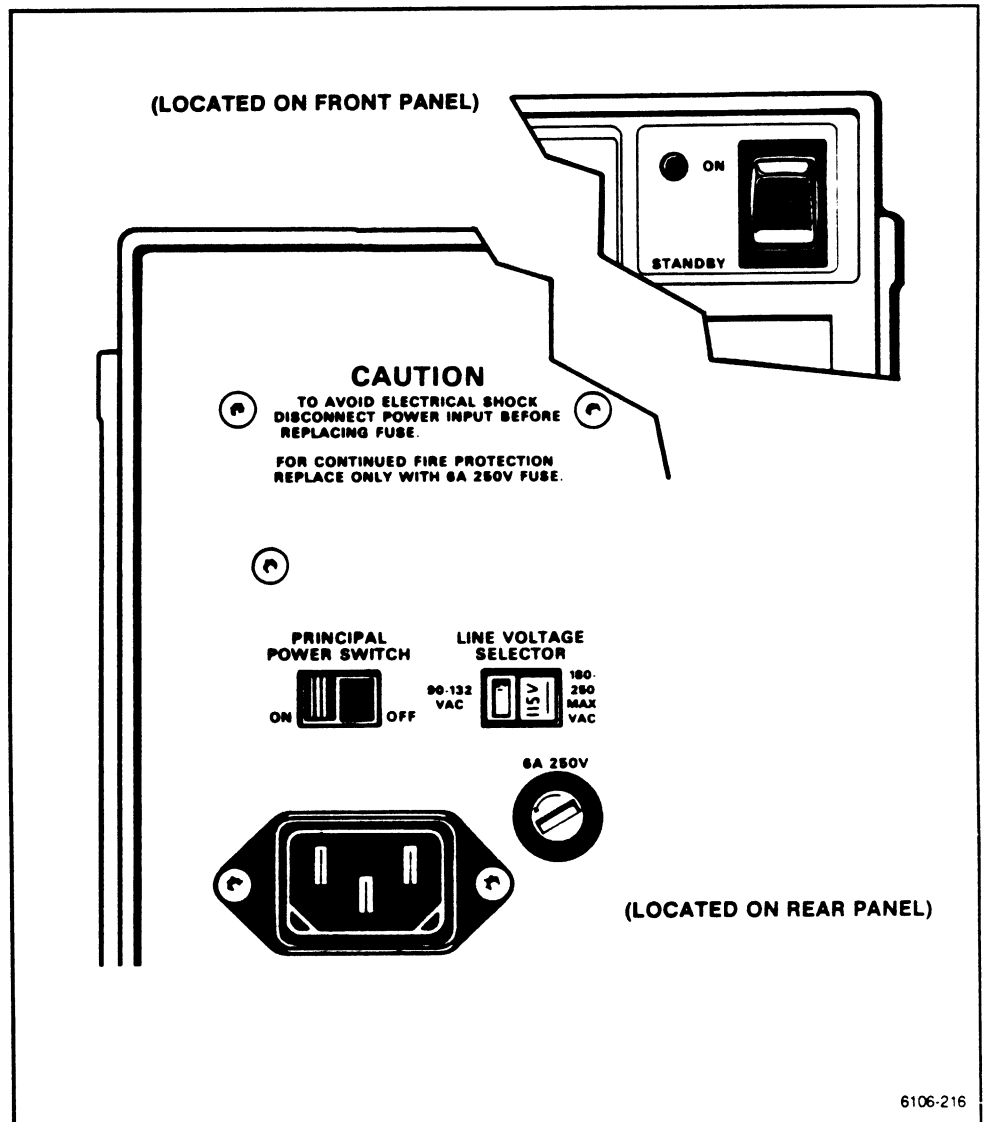

Figure 2-17. The PRINCIPAL POWER SWITCH (rear panel) and ON/STANDBY switch (front panel).

Power-Up Information

First attach the detachable power cord to the receptacle in the rear of the instrument. Once this is done, the oscilloscope must be plugged into the appropriate power source. See Section 1, "Operating Power Information." After this is accomplished, slide the PRINCIPAL POWER SWITCH located on the right side on the rear of the instrument to the ON position. The front-panel ON/STANDBY switch on the right, upper corner of the instrument applies power to the entire oscilloscope. Press this switch to ON. An indicator next to the ON/STANDBY switch illuminates when both the PRINCIPAL POWER SWITCH and the ON/STANDBY switch are in the ON position.

The PRINCIPAL POWER SWITCH is meant to remain ON; thereby, keeping the power supply and the optional Counter/Timer oven constantly in the "warmed up" condition. The ON/STANDBY switch must be in STANDBY when inserting or removing plug-ins. (See "Installing Plug-in Units" in Section 1 of this manual.

In computer controlled applications, it may be desirable to disable the front-panel ON/STANDBY switch. There is a means to secure it electrically in the ON setting; this procedure is to be performed only by qualified service personnel.

CAUTION

To prevent possible damage to plug-in units or the mainframe, do not attempt to remove or install plug-in units if the ON/STANDBY switch has been disabled (locked ON) and the PRINCIPAL POWER switch is ON.

As soon as both the PRINCIPAL POWER SWITCH and the front-panel ON/STANDBY switch are ON, a self-test verifies the instrument functionality. This test can also run from a menu (see "Test" under "Instrument Verification" in this subsection and "Test" under "Utilities" later in this section for detail).

The settings upon power-up will be the same as when previously powered-down. If these settings are not desired, you may initialize the instrument to a predefined known state. See the discussion of "Oscilloscope Initialization" in this subsection and also see "Initialize" in the "Utility" subsection.

Instrument Verification

The functionality and accuracy of the instrument is verified in several ways: calibration, diagnostics, and self-test.

Calibration

The 11301 and 11302 Programmable Oscilloscope has the ability to calibrate itself to achieve a state of enhanced accuracy. Enhanced Accuracy is typically twice Not-Enhanced Accuracy. All accuracy specifications pertain to Enhanced Accuracy with all plug-in compartments full to ensure proper ventilation.

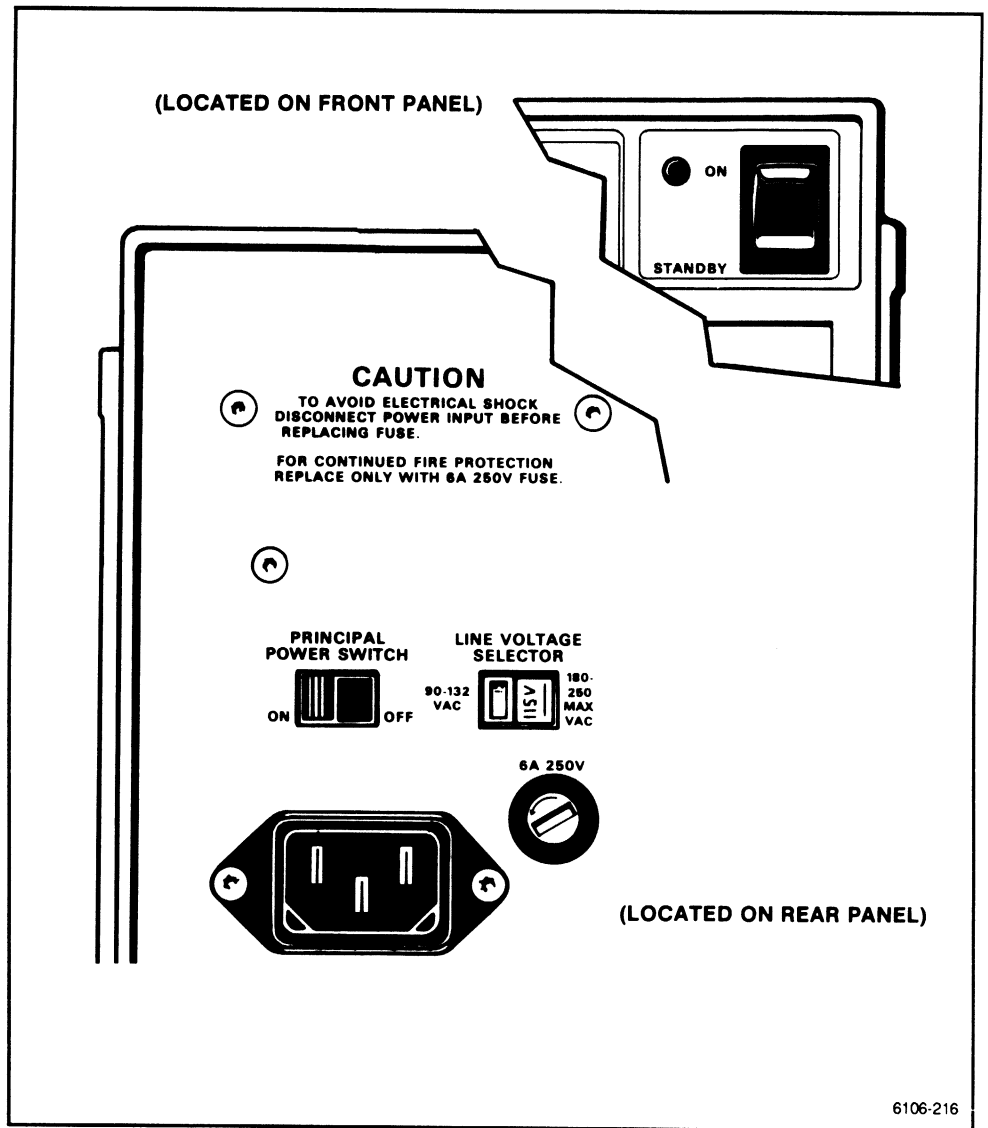

Figure 2-17. The PRINCIPAL POWER SWITCH (rear panel) and ON/STANDBY switch (front panel).

Power-Up Information

First attach the detachable power cord to the receptacle in the rear of the instrument. Once this is done, the oscilloscope must be plugged into the appropriate power source. See Section 1, "Operating Power Information." After this is accomplished, slide the PRINCIPAL POWER SWITCH located on the right side on the rear of the instrument to the ON position. The front-panel ON/STANDBY switch on the right, upper corner of the instrument applies power to the entire oscilloscope. Press this switch to ON. An indicator next to the ON/STANDBY switch illuminates when both the PRINCIPAL POWER SWITCH and the ON/STANDBY switch are in the ON position.

The PRINCIPAL POWER SWITCH is meant to remain ON; thereby, keeping the power supply and the optional Counter/Timer oven constantly in the "warmed up" condition. The ON/STANDBY switch must be in STANDBY when inserting or removing plug-ins. (See "Installing Plug-in Units" in Section 1 of this manual.

In computer controlled applications, it may be desirable to disable the front-panel ON/STANDBY switch. There is a means to secure it electrically in the ON setting; this procedure is to be performed only by qualified service personnel.

As soon as both the PRINCIPAL POWER SWITCH and the front-panel ON/STANDBY switch are ON, a self-test verifies the instrument functionality. This test can also run from a menu (see "Test" under "Instrument Verification" in this subsection and "Test" under "Utilities" later in this section for detail).

The settings upon power-up will be the same as when previously powered-down. If these settings are not desired, you may initialize the instrument to a predefined known state. See the discussion of "Oscilloscope Initialization" in this subsection and also see "Initialize" in the "Utility" subsection.

Instrument Verification

The functionality and accuracy of the instrument is verified in several ways: calibration, diagnostics, and self-test.

Calibration

The 11301 and 11302 Programmable Oscilloscope has the ability to calibrate itself to achieve a state of enhanced accuracy. Enhanced Accuracy is typically twice Not-Enhanced Accuracy. All accuracy specifications pertain to Enhanced Accuracy.

To invoke the self-calibration process, press the EA button labeled ENHANCED ACCURACY near the top of the instrument. Since it is easy to inadvertently press the EA button, a second confirmation push of the EA button is necessary to actually cause calibration to begin. Any different second action that is not another EA button push will cancel the pending button push.

To invoke the self-calibration process, press the EA button labeled ENHANCED ACCURACY near the top of the instrument. Since it is easy to inadvertently press the EA button, a second confirmation push of the EA button is necessary to actually cause calibration to begin. Any different second action that is not another EA button push will cancel the pending button push. The first time the EA button is pressed, the following message appears on the screen.

"Press EA again to confirm request".

If calibration is successful, the following message will be displayed at the completion of the process.

"Self calibration completed successfully".

There are actually four states of accuracy that can exist. They are warm-up, new configuration, not-enhanced, and enhanced. When the oscilloscope is first powered on, accuracy is in the warm-up state for the first 20 minutes. When the warm-up period expires, one of the other three states is entered depending on a number of factors. See the state diagram in Figure 2-18.

If there has been a change in plug-in units since the last time the oscilloscope was enhanced, the state of new configuration is entered; otherwise, the state of not-enhanced is entered. At either of these two points, if self-calibration is in Auto mode, the calibration process is started automatically and the enhanced accuracy state is entered at the completion of calibration.

Once in the enhanced state, the system (including plug-ins) will remain enhanced until the internal temperature changes by more than 5 degrees Celsius. If that happens, accuracy reverts to not-enhanced unless self-calibration is in Auto mode in which case the calibration process is started automatically.

Self-calibration can be either **Auto** or **Manual**. If **Auto MODE** has been selected in the Calibration menu and the warm-up period has expired, self-calibration will automatically begin anytime that the accuracy is not enhanced.

If **Manual MODE** has been selected in the Calibration menu and a new plug-in has been installed since the last calibration, the following message will appear when the 20 minute warm-up period expires.

"Warmup Complete. New config requires Cal. Press EA"

If the Calibration **MODE** is **Manual** and the accuracy is enhanced, then if the temperature changes by 5 degrees Celsius or more, accuracy becomes not-enhanced and the following message is displayed on the screen.

"Temp change since last Cal. Press EA to restore"

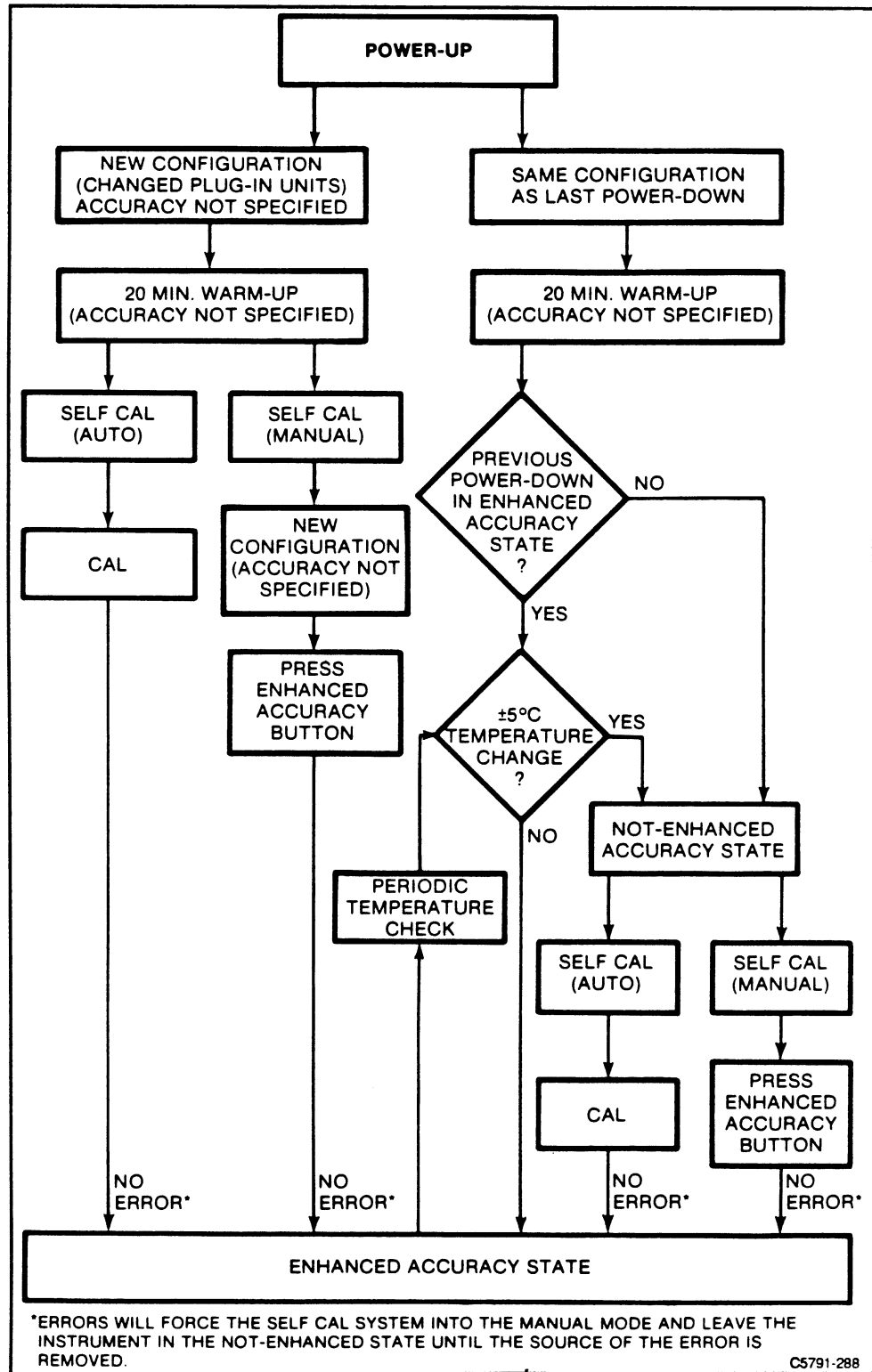

Figure 2-18. State diagram for Enhanced Accuracy.

The first time the EA button is pressed, the following message appears on the screen.

"Press EA again to confirm request".

If calibration is successful, the following message will be displayed at the completion of the process.

"Self calibration completed successfully".

There are actually four states of accuracy that can exist. They are warm-up, new configuration, not-enhanced, and enhanced. When the oscilloscope is first powered on, accuracy is in the warm-up state for the first 20 minutes. When the warm-up period expires, one of the other three states is entered depending on a number of factors. See the state diagram in Figure 2-18.

If there has been a change in plug-in units since the last time the oscilloscope was enhanced, the state of new configuration is entered; otherwise, the state of not-enhanced is entered. At either of these two points, if self-calibration is in Auto mode, the calibration process is started automatically and the enhanced accuracy state is entered at the completion of calibration.

Once in the enhanced state, the system (including plug-ins) will remain enhanced until the internal temperature changes by more than 5 degrees Celsius. If that happens, accuracy reverts to not-enhanced unless self-calibration is in Auto mode in which case the calibration process is started automatically.

Self-calibration can be either **Auto** or **Manual**. If **Auto MODE** has been selected in the Calibration menu and the warm-up period has expired, self-calibration will automatically begin anytime that the accuracy is not enhanced.

If **Manual MODE** has been selected in the Calibration menu and a new plug-in has been installed since the last calibration, the following message will appear when the 20 minute warm-up period expires.

"Warmup Complete. New config requires Cal. Press EA"

If the Calibration **MODE** is **Manual** and the accuracy is enhanced, then if the temperature changes by 5 degrees Celsius or more, accuracy becomes not-enhanced and the following message is displayed on the screen.

"Temp change since last Cal. Press EA to restore"

See "Calibration" in the "Utilities" subsection for information on how to change the self-calibration mode from Auto to Manual and vice versa.

If for some reason the instrument failed to calibrate, the instrument is left in the not-enhanced state, the self-calibration mode is automatically changed to Manual, and a message explaining the failure is displayed.

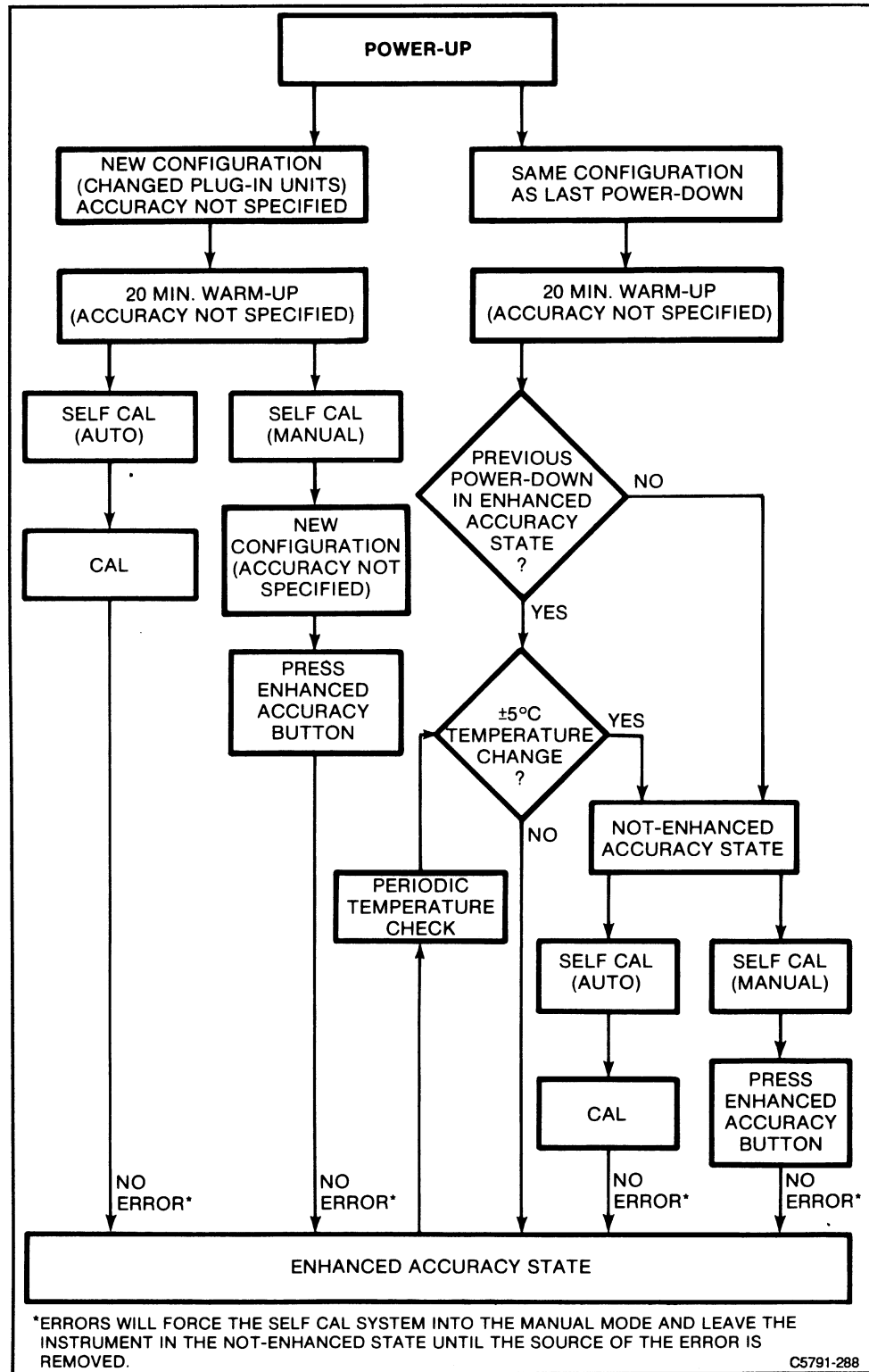

Figure 2-18. State diagram for Enhanced Accuracy.

WARNING

It is inadvisable to change the configuration of the oscilloscope system while Enhanced Accuracy is being performed. For best results DO NOT attach or remove probes at the plug-ins and DO NOT remove or insert plug-ins during the Enhanced Accuracy process.

To indicate when the instrument is in Enhanced Accuracy, the symbol E_A will appear in the lower right hand corner of the screen at the end of the line that contains the value of the right knob. See Figure 2-19. When accuracy is anything but enhanced, this icon will not be displayed.

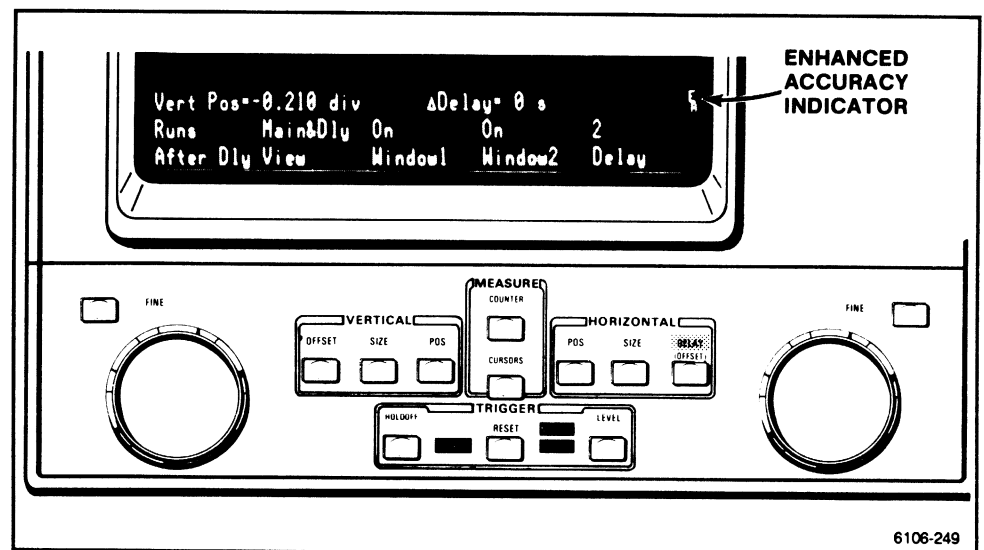

Figure 2-19. Enhanced Accuracy indicator on the lower right of screen.

Attempting to run calibration before warm-up period has expired results in the following message being displayed where N is the number of minutes remaining before the 20 minutes are up.

"Enhanced Accuracy avail after warmup in N minutes"

Diagnostics

These procedures check and adjust performance criteria. They should be used by qualified service personnel only.

Diagnostics, Cal, and Test contribute to overall functionality and performance accuracy of the instrument and should be considered as a whole and not in part.

Self-Test

Test (self-test) verifies the functionality of the instrument prior to or during normal operation. Test is intended to exercise a major portion of the instrument circuitry to determine if that circuitry is functioning properly.

Test runs automatically without operator intervention and is invoked as a single unit through GPIB and RS-232-C commands selected from the Test menu accessed through the UTILITY major menu, or by moving the ON/STANDBY switch to ON (assuming the PRINCIPAL POWER SWITCH is also ON).

The Test feature may be disabled from automatic calibration through *Cal* in the UTILITY menu.

GPIB and RS-232-C

Test will be invoked by sending the command TEST to the instrument. While Test is in progress, the busy bit is asserted. If RQS is ON and SRQMASK OPCMPL is ON, upon completion of Test the normal GPIB communication protocol of asserting SRQ with status byte will follow.

UTILITY Menu

Test may also be invoked from the UTILITY menu. See the "Utilities" subsection for more detail.

Power On

Test first tests the mainframe, then proceeds to test any installed 11A-series plug-ins. When Test is first invoked, it performs two sets of tests: kernel verification and instrument verification. Kernel verification turns all LEDs on the front panel on. When kernel verification completes with no failures, all the LEDs are turned off and Test automatically goes into instrument verification.

If no faults are encountered, the self-test completes in about two minutes, sending the POWERON event code to the RS-232-C and GPIB buses and returns the oscilloscope to normal operating mode. Any failure causes the SELFTEST FAILED event code to be sent to the external buses and the extended diagnostic block menu to be placed on the screen if possible. The Test halts at any failure; pressing any major menu button will continue the test.

If a fault is detected during kernel verification, a two-LED code will blink on the major menu LEDs indicating the device in question.

NOTE

Since failure codes refer to specific devices, they are not listed here. Devices should be replaced by qualified service personnel.

If a fault should occur once into instrument verification, the display then shows a block menu and the failed parameter is shaded.

In some cases, a noncatastrophic failure may occur and you may choose to continue to use the instrument. The instrument may still be operable, but Tektronix cannot guarantee its accuracy. The instrument should be referred to qualified service personnel immediately. Consult your service department, local Tektronix Service Center, or nearest Tektronix representative for additional assistance.

Self-test Not at Power On

When self-test is run other than at power on, either the "SELFTEST PASSED" event or the internal Error event "SELFTEST FAILED" message is sent to the source of the test invoked. Additional information on a test failure is possible by using the Ext Test entry in the UTILITY menu or TEST? on an external interface.

Oscilloscope Initialization

To set the Programmable Oscilloscope to a known starting state, press the UTILITY major menu button and touch the *Init* selection on the screen. This will bring the oscilloscope to the conditions shown in Table 2-1. Refer to "Initialize" in the "Utilities" subsection.

TABLE 2-1
Initial Oscilloscope Conditions

Selection	Subset	Function	Setting	Comments
Traces				All are deleted.
Autoset		Amplitude Timing	On On	
Knob Assignments		Right Knob Left Knob	Vertical POSition Horizontal POSition	No control menu displayed.
Vertical POSition		Position	0.0 div	
Plug-ins			Depends on plug-ins	
Horizontal SIZE and POSition		Display 10X Mag Main Time/div Dly'd Time/div Position	Auto Off 100 μ s 10 μ s 0.0 div	
Horizontal Delay		After Dly View Window 1 Window 2 Delay Delay 1 Delay 2	Runs Main&Dly Off Off 1 100 μ s 800 μ s	
Cursors	Horizontal	Solid Position Dotted Position Set Ref Tracking % Degree	3 divs left of center 3 divs right of center 5 divs Off Off	No Cursors displayed.
	Vertical	Solid Position Dotted Position Set Ref Tracking % dB	2 divs below center 2 divs above center 5 divs Off Off	
Intensity		Knob Selection CHAR MAIN DLY'D XY GRAT	CHAR (characters) Factory Preset Factory Preset Factory Preset Factory Preset 0%	

TABLE 2-1 (cont)
Initial Oscilloscope Conditions

Selection	Subset	Function	Setting	Comments
Counter	Measure=Off	None	None	
	Measure=Frequency	Averages Gating Update Source Reference	Auto Off Auto Main Trig 0.0	
	Measure=Period	Averages Gating Update Source Reference	Auto Off Auto Main Trig 0.0	
	Measure=Width	Averages Gating Update Source Reference	Auto Off Auto Main Trig 0.0	
	Measure=Ratio	Averages Gating Update Source Reference	Auto Off Auto M&D1 Trig 0.0	
	Measure=Total	Gating Update Source	Off Stopped M&D1 Trig	
	Measure= Time A→B	Averages Update Source Reference	Auto Auto Swp Start 0.0	
Trigger Holdoff	Holdoff=Time			Setting= minimum available at 100 μs/div.
	Holdoff=Events	After HO One Start Count Start	Runs Off 2 ns Main Trig	
Trigger Level	Main	Level Mode Sensitivity Coupling Slope	0 div (midrange) P-P (Peak-to- Peak Auto) Medium Dc +	
	Dly1 and Dly2	Level Sensitivity Coupling Slope	0 div (midrange) Medium Dc +	
	CT Ext A and CT Ext B	Level Slope	0.0 +	

TABLE 2-1 (cont)
Initial Oscilloscope Conditions

Selection	Subset	Function	Setting	Comments
Trigger Source Major Menu		Main Dly1 Dly2		No triggers defined, in trigger pending state.
Waveform Major Menu		Ref Wfm1 Ref Wfm2	All zeros All zeros	
Measure Major Menu		Meas List	No measurement selected.	
Store Recall Major Menu		No change		
Disp Adj Major Menu		Focus Astig Trace Rot Δ Main (contrast) Δ Char (contrast)	No change No change No change 50% 20%	
Utility Major Menu	Autoset	Amplitude Timing	On On	
	Beep	Buttons	Soft	
	Calibration	Mode	Man	
	Cal Signal	Type Amplitude Frequency	Sq Wave 5 V 1 kHz	
	Ext Test	No setting		
	GPIB	No Change	No Change	
	Input/Output Bnc	Gate Out Ref Clock	Main Int	
	Probe Cal	No selection		
	Probe ID	Autoset Sequence Measure	On Off Off	
	RS232	No Change	No Change	
	Test	No setting		
	Time and Date	Date Time	Off Off	

TABLE 2-1 (cont)
Initial Oscilloscope Conditions

Selection	Subset	Function	Setting	Comments
GPIB/RS-232-C		Display Text	Dots None	Text string cleared.
	Waveform Memory	Output Input Encoding XMULT XINCR XZERO XUNIT YMULT YZERO YUNIT	ST01 ST01 Ascii 100 1 0 "knot" 1 0 "slug"	
	Setting	Encoding	Ascii	
	Redirect	GPIB RS232 LONGFORM DEBUG FPANEL	OFF OFF ON OFF ON	
	SRQMASK	CMDERR EXERR INERR EXWARN INWARN OPCMPL USER IDROBE CALDUE	ON ON ON ON ON ON OFF OFF ON	
	Interrupts	RQS	ON	

Display Area

This subsection discusses the operation of the display.

In analyzing how novice users tend to learn the operation of the oscilloscope, we find they base their choices by observing the response in the display area while "experimenting" with the controls. Therefore, each selection is executed immediately to give you reinforcement and feedback needed to learn the operation of the instrument. Viewing all possible settings at one time is not necessary.

All operation, presentation, and definition apply to both the 9.8 cm x 12.2 cm 11301 crt display and the 8 cm x 10 cm 11302 crt display. Figure 2-20 shows the display format.

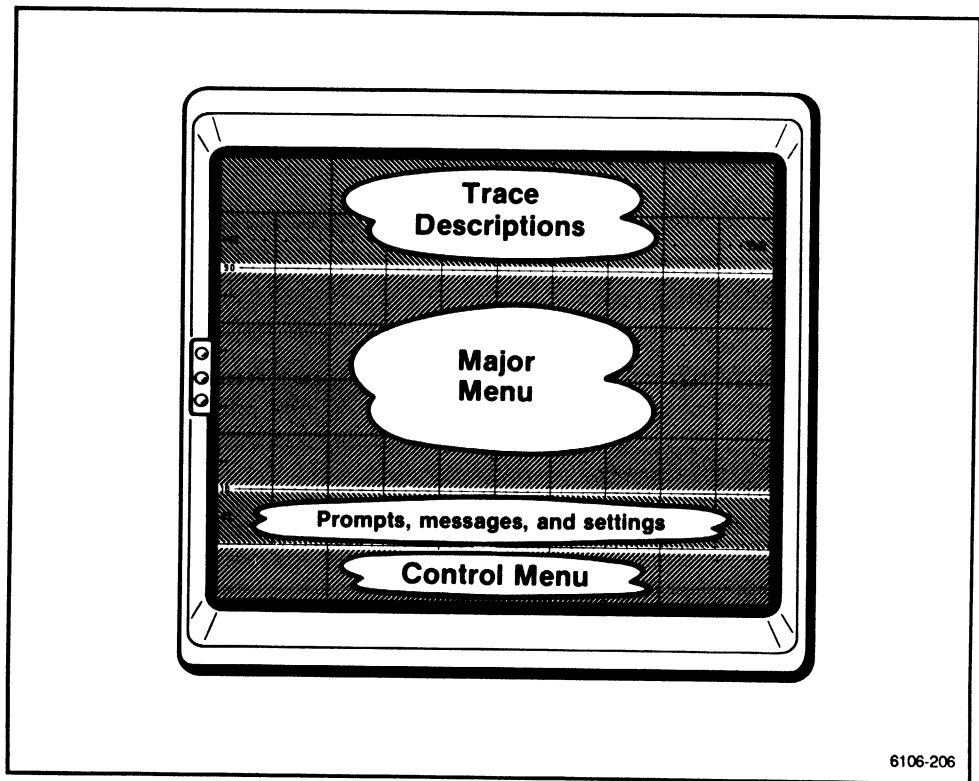

Figure 2-20. Display Format.

To display a menu you must first push either a major-menu button or a control-menu button. Each menu gives you choices that may be selected or changed by touching areas on the screen.

Control Menus

In this discussion, the general behavior of the control dependent menu is defined. The choices presented are those we anticipate to be especially convenient or that interact with a particular adjustment. Traditional front-panel controls (buttons) for modes, coupling, etc. are found in the control menus. This allows immediate access to other functions that interact with the present setting. These menus appear near the bottom of the display (see Fig 2-20).

Touching a menu function repeatedly causes its state to cycle through several choices. There is no need for a lengthy menu history (trail) as the control menu is the result of the most recent knob assignment.

Access to Control Menus

Pressing one of the buttons (except COUNTER and TRIGGER RESET) located between the two control knobs below the crt assigns one or both of the knobs. (CURSORS are assigned when either **Horiz** or **Vertical Cursors** is selected). Whenever a knob is assigned to a desired function, a menu appears at the bottom of the display just above the knobs. This menu appears only if there are some relevant or related choices to offer. For example, when using the 11A32, selecting the VERTICAL SIZE knob assignment displays a menu offering choices to control Input *Coupling*, Input *Impedance*, and *HF Limit*. Each choice and present status occupy a touch zone, touching that area changes the status.

Repeated touching of the function cycles or scrolls through the available states. For example, touching *Coupling* when it's set for **Ac** changes it to **Dc**, touching again changes it from **Dc** to **Off**, and touching another time returns it to **Ac**. (See Figs. 2-21 and 2-22.)

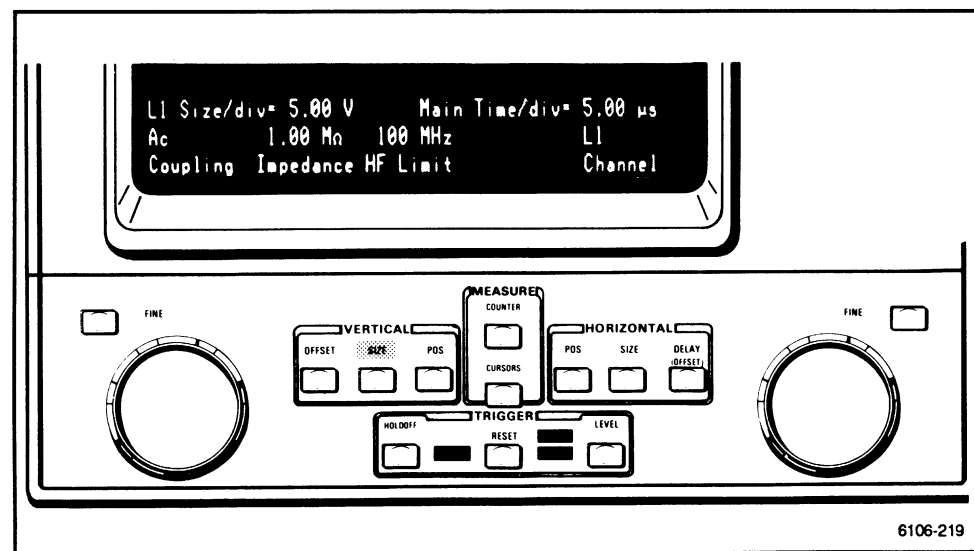

Figure 2-21. The Vertical menu with **AC Coupling** selected.

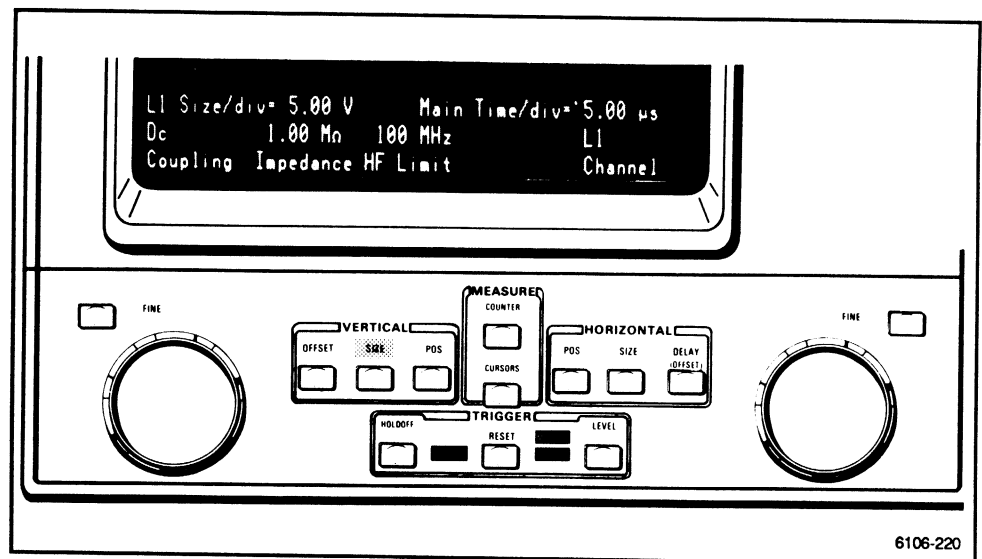

Figure 2-22. The Vertical menu with *DC Coupling* selected.

When another knob assignment is made, the associated menu has priority over the previous control menu and removes the old menu from the display. Although the state of the previous control menu is maintained, the menu itself can be accessed only by changing the knob assignment back to the previous one. Knob assignments for a given control are mutually exclusive, that is, choosing a new assignment cancels the previous one.

Alternate presses of any control button will remove and restore its menu. By such action, a menu can be turned on (see Fig. 2-23) for making selections or turned off (see Fig. 2-24) to make more area available for viewing traces. When turned off, the prompting message line and the knob setting line drop to the bottom two display lines.

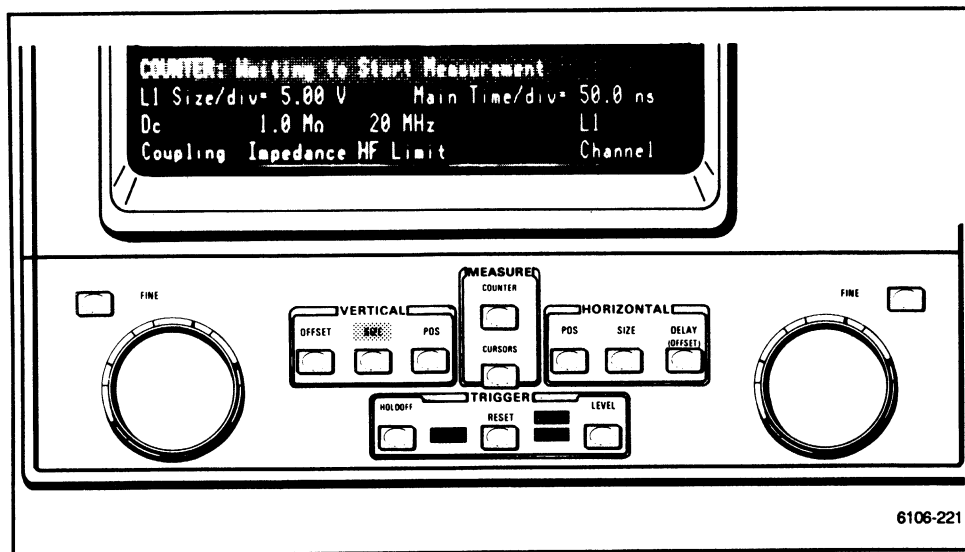

Figure 2-23. The prompt line, the knob setting line, and the two-line menu lines. This menu is On.

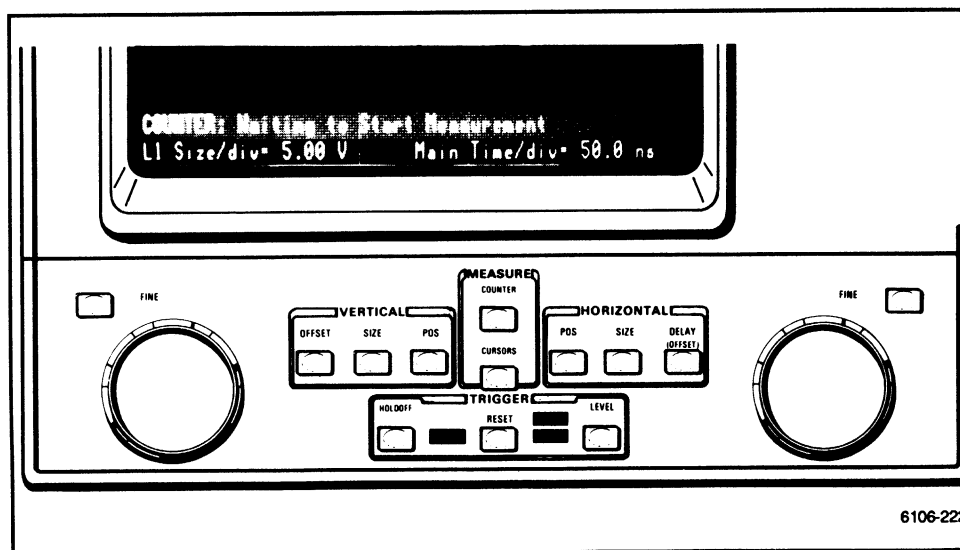

Figure 2-24. When the menu is Off, only the prompting and knob setting line appears.

Control menus can be operated as long as the associated control is still active even while major menus are active (except for the DISP ADJ major menu). To let you maintain control over the knob assignments, the knobs are not generally commandeered and reassigned by a major-menu action except for a few calibration adjustments.

For different knob assignments, the behavior of the knob may be different. For example, adjusting vertical offset is usually controlled in linear increments, whereas the time-base time/div is controlled in exponential increments (1-2-5-10...). In addition, the FINE button can change the time/div increments from coarse exponential to fine linear ones.

The buttons, located between the two knobs below the display, call seven different types of control menus when pressed: VERTICAL SIZE, POSition, or OFFSET buttons display the Vertical menu; HORIZONTAL SIZE and POSition display the Horizontal menu; HORIZONTAL DELAY displays the Delay menu; TRIGGER HOLDOFF displays the Holdoff menu; TRIGGER LEVEL buttons displays the Trigger Level menu; the COUNTER button displays the Counter/Timer menu; and the CURSORS button displays the Cursor menu.

Knobs

The two large knobs located below the display (crt) are assigned their functions by the adjacent buttons. (See Table 2-2.) To use these knobs see "Control Menus" and specific control menus: Horizontal, Vertical, Trigger, Counter, and Cursors.

**TABLE 2-2
Knob Assignments**

Menu	Left Knob	Right Knob
VERTICAL	OFFSET SIZE POSition	No change
COUNTER	No change	No change
CURSORS Horizontal Vertical	Solid cursor Solid cursor	Dashed cursor Dashed cursor
TRIGGER HOLDOFF	HOLDOFF	No change
TRIGGER LEVEL	No change	LEVEL
HORIZONTAL	No change	POSition SIZE
HORIZONTAL DELAY		DELAY
DISP ADJ	Focus	Astig Trace Rot Δ Main Δ Char

Major Menus

To the immediate right of the crt is a column of "major menu" buttons. These mutually exclusive buttons provide a direct path to major or complex menu structures independent of previous selections. When a selection is made, the previous menu is exited. If the previous operation was incomplete, it will be terminated and revert to the previous operation.

A history of the last menu state or condition is maintained, so when entered later, conditions are as they were when previously exited. Major menu buttons are alternate action (alternate presses of the same button displays or exits and removes the menu) and mutually exclusive of each other.

On major menus, a visual acknowledgement to a touch selection is displayed to indicate the interpretation of the selection by the oscilloscope. The oscilloscope shades the area around the menu entry it thinks you selected. In this way you get feedback, so your aim can be adjusted or you can change your mind if you erred.

Numeric Displays

Numeric displays of settings and computed results are formatted as a mantissa followed by a symbol serving as exponent (power of ten) followed by a dimension or unit. The mantissa is greater than or equal to one and less than 1,000. The exponents are integer multiples of three as represented by accepted SI (Système International d'Unités) notation (e.g., $10^3=k$, $10^{-6}=\mu$, etc.). Any exceptions are noted in this document.

Prompt and Message Areas

A prompt line appears near the bottom of the display. Helpful messages will be displayed prompting you to take corrective action after an error occurs or to clarify an operation. Any advisory message (prompts, errors, warnings, etc.) appears with background shading over the entire line (see Fig. 2-25).

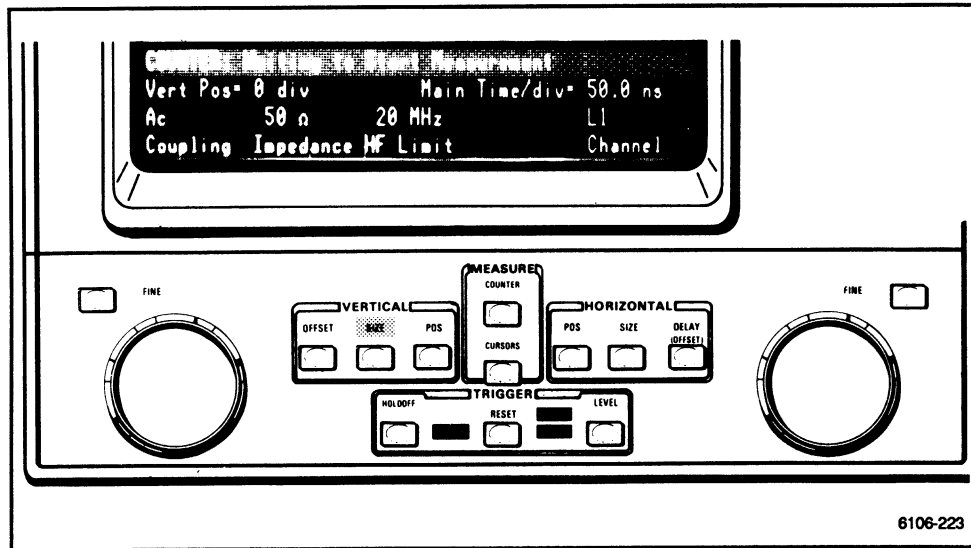

Figure 2-25. The Vertical menu with a helpful message.

Touch Panel

The Touch Panel allows you to make choices by touching the screen. A touch interrupts an infrared light beam that is transmitted across the crt (parallel to the screen surface) to sensors. Interrupting the light beam is interpreted into a viable function similar to pushing a button. After touching a selection, menus give visual acknowledgement by changing the parameter status presented on the screen or by shading a selected choice.

Waveform Display

Traces are defined and displayed three ways: one way uses the WAVEFORM major menu method; a second, simple method, is pressing the display on/off button of a plug-in channel; and finally, by pressing the probe ID button. See the "Waveform Acquisition" subsection for details.

When a trace is selected, its intensity is temporarily boosted (increased) for approximately one second to aid in identifying it from other traces.

If the trace uses only one input channel or uses two input channels having the same sensitivity or is an XY trace using only two input channels, the vertical scale factor is displayed as part of the trace description.

Up to eight unique waveforms can be displayed. An X-versus-Y trace is considered a single trace even though it can be created from two or more input signals.

Waveform Acquisition

This subsection discusses how to display a waveform. Its categories are in alphabetical order. You find your selection as you do in a dictionary.

Acquiring Waveforms

Traces may be acquired using two other methods besides the WAVEFORM major menu. These two ways are either by pressing the display on/off button on the plug-in or the ID button on the probe.

Acquiring a Trace using the Display On/Off Button

Each amplifier channel has an associated display on/off button. This is generally the only button per input channel on an amplifier. The on/off button is intended to serve as an obvious means to create and delete traces. When pressed, the input state of the channel will alternate between on and off. An illuminated LED indicates when an input is in use. The LED is off when the channel is not used.

When a channel display is turned off, all traces using the channel will be deleted! No history will be maintained to allow for recovery if the display is accidentally turned off. When the display of the channel is turned on again, only one trace is created: that channel versus the main time base.

Acquiring a Trace with the Probe ID Button

Pressing the probe ID button from the LEFT or CENTER compartment always (unless Front Panel Lockout is in effect) results in a defined trace without the need to access any menus if the channel isn't already in use and if there is space to create a new trace. This method is limited to designating a trace that is composed of an individual input channel versus the Main time base. It is most likely that this represents a common configuration used by the majority of oscilloscope users.

If an XY display or a multiple input-channel composite trace is desired, it must be constructed using the WAVEFORM major menu choices (see "Waveform Menu" at the end of this subsection). When invoked, this large menu appears offering the means to create a new trace. From this menu, all available input channels can be combined into a maximum of eight unique traces including delayed and XY traces.

If the WAVEFORM major menu is displayed, the probe ID buttons behave the same as when the menu is not displayed, that is, pressing the ID button creates and completes the trace. "ID Chan1" + "ID Chan2" is not permitted.

Autoset

The Autoset feature helps to create an acceptable oscilloscope display. This feature is intended to assist you so that only a few simple modifications are required to obtain the desired display. No attempt is made to judge or guess which of the previous oscilloscope settings should be left unmodified. For example, triggering will always be affected. The *Autoset* selection from the UTILITY menu allows you to disable the amplitude or time base scaling.

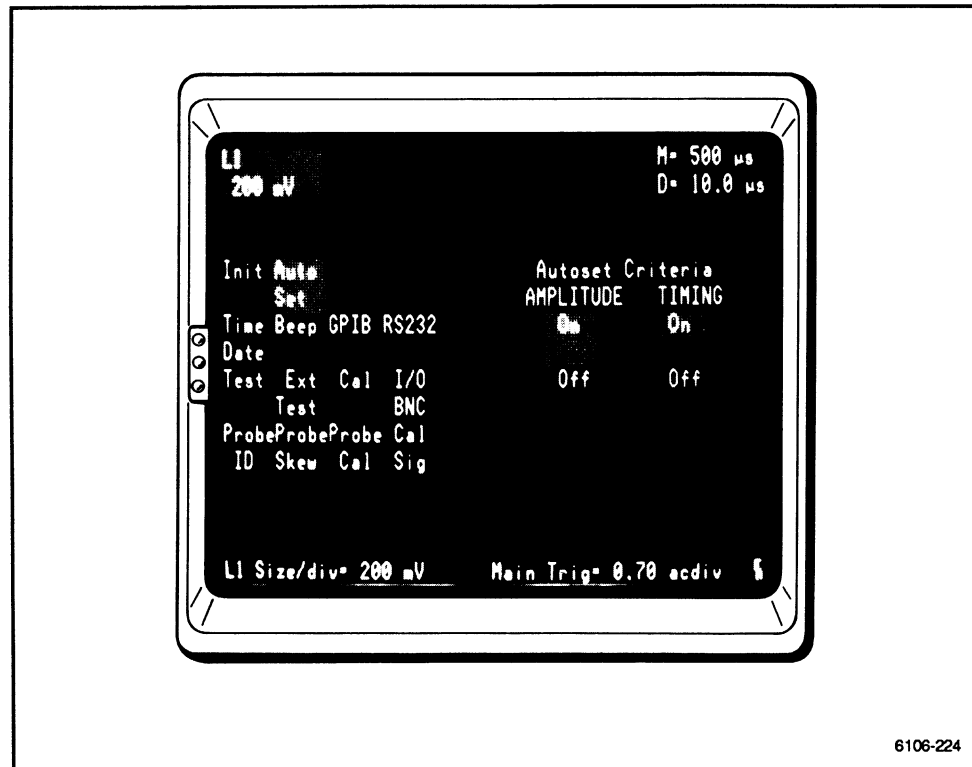

Figure 2-26. Autoset menu.

Autoset Operation

Assuming that *Autoset* and *Probe ID* are enabled, Autoset can be initiated by pressing one of two buttons: the ID button on the probe or the AUTOSET button on the mainframe. Pressing either button initiates the process once. No action relating to Autoset is taken when the button is released.

NOTE

If Front Panel Lockout is in effect, Autoset cannot be enabled through the front-panel or probe ID button.

Autoset does not continually monitor the trace or input and make adjustments whenever it sees fit. Instead, you ask for it to take control momentarily. When the oscilloscope has either found and displayed the signal or given up, control is returned to you.

When setting a channel, the algorithm attempts to preserve dc coupling by offsetting the signal to make the trace appear on the display. If there is not enough offset available to view the ac component, dc coupling is abandoned and ac coupling is used with zero offset.

To set the Time/div on the main time base, the signal must have a repetition rate between about 30 Hz and 500 MHz. The delayed time-base trigger level is modified to equal the main time-base trigger level. The trigger sources for the main and the delayed triggers are set equal to the vertical component of the selected trace.

AUTOSET Button

The mainframe AUTOSET button acts on the selected trace. If the trace is composed of more than one input, whether for vertical or horizontal deflection, all inputs comprising the trace will be scaled. Each input channel will be scaled individually. When all of the inputs are scaled, they are combined once again into the original expression.

Timing for the main and delayed time bases is based on the composite trace by creating a trigger expression to match the trace description. In the case of XY traces, only the vertical portion of the expression will be used for the triggering.

The **Main** time base will be scaled to view a few, two to five, cycles or events of the trace if the signal has a duty factor of near 50%. The oscilloscope will scale based upon the width of the signal. The Time/div will be near the measured width. An attempt to find a positive or negative width will be made, thereby, obtaining low duty factor signals and presenting the leading pulse. The **Dly'd** Time/div will be set to view a transition (about twenty times faster than the main) rather than a few cycles. An attempt will be made to place Window 1 on the first transition relative to the start of the main sweep (zero delay). Window 2 will be placed on the next transition (the width value). The **Dly'd** Time/div and *Delay* values are not modified if no windows exist. By placing the window on a transition and adjusting its Time/div, a trace having some two-dimensional interest may help maintain your orientation.

Whenever Autoset is performed on any trace, the main time base will be adjusted. If present, the windows will also adjust whenever any trace is automatically scaled.

Probe ID Button

The ID button of any probe attached to an 11A-Series amplifier can be used to perform Autoset on its channel and the time bases. This differs from the AUTOSET button on the mainframe in that the probe ID button will only initiate the scaling of the attached input. Autoset from the probe tip allows remote initiation of the scaling process without reaching for the mainframe. In such cases, a user is typically probing around a circuit hunting for signals, and it is highly unlikely that two channels have been combined to create a trace. Therefore, the probe ID initiation method is optimized for operating on a single channel per trace. The time bases are still adjusted as described for the AUTOSET button.

The way to enable or disable the initiation of the probe Autoset is found in the UTILITY menu as *Probe ID*. As this button can take on several meanings simultaneously, this menu shows the status of the ID initiated functions. See the "Probe ID" in this subsection for more detail.

Interactions with other Functions

When Autoset is completed, the control knobs are always set to these assignments:

Left Knob—VERTICAL POSition

Right Knob—HORIZONTAL SIZE (with **Main** Time Base selected.)

Intensity Knob (top)—MAIN sweep intensity

Along with these control knob assignments, the Vertical menu of one of the inputs that has been automatically scaled is active and displayed.

Oscilloscope Functions that can be Autoset:

Vertical Menu

- VERTICAL POSition (set to zero)
- Input OFFSET
- Input *Coupling* (dependent upon offset range and sensitivity)
- Input *Impedance* (set to 1 M Ω if selectable)
- Input Bandwidth (set to maximum)

Horizontal Menu

- HORIZONTAL POSition (set to zero)
- Main and delayed 10X *Mag* (set to **Off**)
- Main and Delayed Time/div

Holdoff Menu

- HOLDOFF (set to minimum)

Trigger Menu

- Main, Dly1, and Dly2 trigger *Level* (set the same as determined by **P-P Auto**)
- Main and Delayed 1 trigger *Coupling* (set to **Dc**)
- Main and Delayed trigger *Sensivity* (set to **LOW**)
- Main trigger *Mode* (set to **P-P Auto**)
- Main and Delayed trigger *Slope*
- Main, Dly1, and Dly2 trigger sources set to the vertical component of the selected trace

Delay Menu

- Delayed time base (set for **Runs After Dly**)
- Delay reference values for *Dly1* and *Dly2* (*Dly1* set to 0.0, and *Dly2* set to width value)

Intensity Levels

- Main, Dly'd, and XY

Menu Selections

The Autoset UTILITY menu provides several ways for you to specify the behavior and criteria to control automatic scaling. See Table 2-3 for a list of menu choices.

Amplitude—constraints can be selected from **Off**, nothing disturbed or **On**, which allows the oscilloscope to set the vertical sensitivity for 2 to 5 divisions of amplitude.

Timing—criteria can be specified for automatic setting of the time base. **Off** prohibits Autosetting of the time base entirely. **On** allows the oscilloscope to set the timing and triggers.

TABLE 2-3
Function Choices of the Autoset Menu

Amplitude	Timing
On	On
Off	Off

The Autoset settings when the oscilloscope is initialized are *AMPLITUDE*, **On**; and *TIMING*, **On**.

The selections for Autoset criteria are found in the Autoset UTILITY menu. To access the menu as shown in Figure 2-26, press the UTILITY button and then touch *Autoset* in the menu, not the front-panel AUTOSET button.

More Autoset Information

If the Autosetting process fails to scale properly (the oscilloscope can't meet the criteria), the previous settings of the oscilloscope will be restored. If the signal is not found, you may expect one of these messages:

"Horizontal signal not found"
 "Vertical signal not found"
 "Signal amplitude too large"
 "Signal amplitude too small"

The conditions to expect at initialization are *AMPLITUDE*=**On**, *TIMING*=**On**, and *Probe ID* enabled for Autosetting. These conditions may be different than those at power-up. See "Oscilloscope Initialization" in the "Oscilloscope Familiarization" subsection.

Beam Find

Many oscilloscopes have a beam finder feature to help you to find an off-screen signal. Although the signal can be found and displayed automatically, the 11301 and 11302 oscilloscopes also offer the familiar beam finder. There are some advantages in that it will not disturb any oscilloscope setting while lending some reassurance as to what is going on.

BEAM FIND will cause the vertical and horizontal gain to compress, force the time bases to free run (except when HOLDOFF is not set to TIME), disable the character readout, and boost all of the display intensities for as long as the button is pressed. When the button is released, the oscilloscope is restored to its prior state.

Delayed Windows ("Delayed Sweeps")

Windows (referred to also as Delayed Sweeps) can be specified by using the HORIZONTAL DELAY menu. Up to two windows can be placed on an individual main time-base trace. That's the same as the traditional "dual-delayed sweep" configuration. Windows are indicated on the main time-base trace as intensified zones. If the main trace is deleted, its associated windows are also deleted. If a window is deleted, the associated intensified zone disappears.

Creating Windows and Intensified Zones

Provisions for creating windows appear in a control menu associated with the HORIZONTAL DELAY button. When the button is pressed, the menu choices are available as shown in Table 2-4.

Table 2-4
Horizontal Delay Menu

After Dly	View	Window1	Window2	Delay
Runs	Main	On	On	1
Trig'd	Main&Dly Dly	Off	Off	2

Repeatedly touching a menu function on the screen cycles through all of the possible choices. (See "Horizontal Menu" for details on XY traces and DELAY button.)

Intensified zones on the Main trace locate the delayed windows relative to the trigger of the Main trace. Since there are only two different delay references, the delay of all windows created using *Delay 1* are changed when delay reference one is adjusted. The same thing occurs when delay reference two is changed.

Delay—is used to assign the DELAY control knob to modify either *Delay 1* or *Delay 2*.

Window1—selections are **On** and **Off**. **On** and **Off** refer to the window and its respective intensified zone controlled by *Delay 1*.

Window2—selections are **On** and **Off**. **On** and **Off** refer to the window and its respective intensified zone controlled by *Delay 2*.

View—allows for the choice of viewing only the Main traces, only the Delayed Window traces, or both Main and Delayed traces. None of these selections will affect the trace descriptions. Traces will be inhibited from view in some cases, but their trace descriptions will remain displayed.

As all of the trace descriptions are touchable at any time, selecting a trace that is inhibited will force the *View* status to **Main&Dly**. This will permit viewing of the newly selected trace.

After Dly—permits qualification of the delayed zones and sweeps. It can be set for **Runs After Dly** to immediately produce a window after the delay value expires. **Trig'd After Dly** has the added qualification of requiring a trigger from the delayed time base (e.g., the proper source, slope, and level).

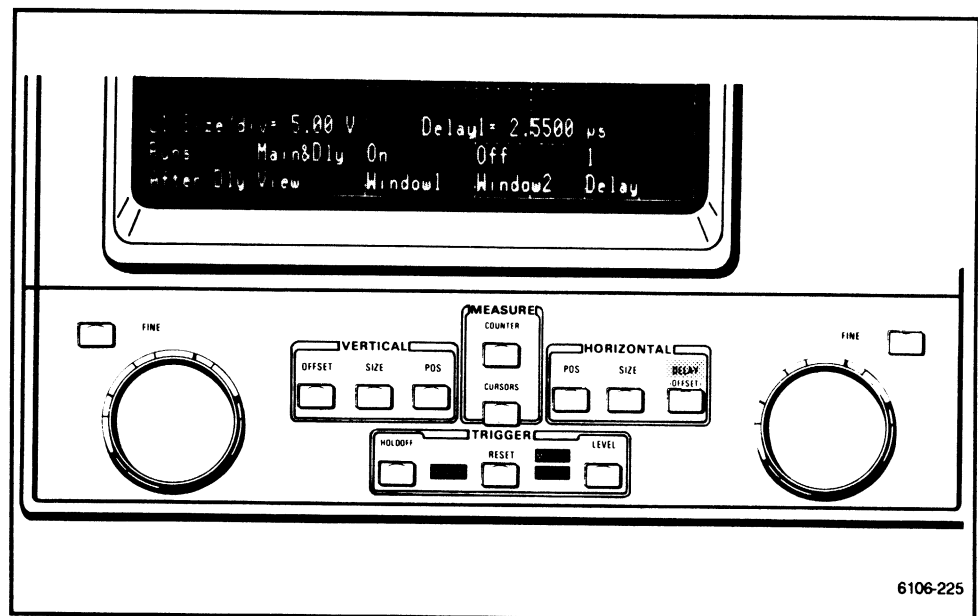

Figure 2-27. The HORIZONTAL DELAY menu for windows and YT traces.

Adjustments of the delay are made using the DELAY control knob and selecting *Delay 1* or *Delay 2* in the menu (see Fig. 2-27). There are no restrictions to inhibit the selection of either one or two.

Delay Readout

Whenever both delay references are in use (window one and two), the readout for the control knob when *Delay* is assigned is " Δ Delay." This is the difference of delay reference number two minus delay reference number one. If only one of the delayed zones or sweeps is displayed, the value reads *Delay* relative to the Main trigger.

If the Counter/Timer is engaged and measuring Time A→B, the result of the Counter may differ from the Delay reading. There are many contributing factors. The largest variation is due to manually adjusting the Delay (1 or 2) based on the intensified zones. As these are approximate indications of the start of the delayed windows, visual errors will increase with faster Time/div.

Delayed Window Restrictions

- The delay reference value cannot exceed the duration of the main sweep (10X Time/div).
- The sweep time (time span) of a window cannot exceed the sweep time of the Main time base. The Main time span must be equal to or longer than the Delayed time-base sweep time.
- No more than two windows can be created from a single Main time-base trace.
- Windows cannot be created from windows.
- Windows cannot be created from Reference waveforms. Any attempt to do so results in the following message being displayed on the prompt line.

"Cannot create a window from a reference trace"

- A window cannot be created if no Main traces exist. Any attempt to create a window when there are no traces defined results in the following message being displayed on the prompt line.

"Window trace requires a main (parent) trace"

- Windows created from XY traces can window only the vertical portion of the XY trace. The result is an intensified zone on the XY trace and a YT display of the windowed section.
- If any delayed windows are defined, the Main Time/div is restricted to sweep no faster than 10 ns/div (10X Mag=Off).
- The combined total number of delayed window traces and main traces cannot exceed eight. When no more traces can be created, touching *Window* does not change **Off** to **On** and this message is displayed:

"Too many traces. Use Waveform menu to clear one"

- If the Main Time/div is less than 10 ns (10X Mag=Off) or 1 ns (10X Mag=On) and no intensified zones are present, the Main Time/div is forced to 10 ns if 10X Mag=Off or 1 ns if 10X Mag=On when a window is created from it.

Selecting Traces

Because the traditional knobs and controls usually found on the plug-ins have been removed, there is no longer a one-to-one correspondence between individual controls and the input channels. On this oscilloscope there is only one set of controls to be shared among all of the displayed traces; therefore, they will operate only on the trace that has been "selected." Only one trace can be selected at a time.

The selected trace will be changed automatically in some cases. See "Trace Selection" in this subsection for more information.

Horizontal Menu

The following discusses the Horizontal control menu functions of POSition, SIZE, and DELAY for YT and XY traces.

Access to Control Menus

Access to control menus occurs whenever a control knob is assigned to a desired function. When another knob assignment is made, the associated menu has priority over the previous control menu and removes the old one from the display. Although the state of the previous selections are maintained, the menu itself can be accessed only by changing the knob assignment to the previous one. Knob assignments for a given control knob are mutually exclusive, that is, choosing a new assignment cancels the previous one.

NOTE

Whenever the Time/div is changed, the oscilloscope attempts to adjust the intensity (+ or -) to maintain reasonable brightness.

Horizontal Position and Size Menu and Delay (Offset) Menu

Whenever HORIZONTAL SIZE or POSition is pressed, the same menu appears (see the following examples). Table 2-5 shows the choices available in this menu.

TABLE 2-5
Horizontal Size and Position Menu Choices

10X Mag	Display	Time Base
On	Alt	Main
Off	Chop	Dly'd
	Auto	

Repeatedly touching a menu function on the screen cycles through all of the possible choices.

Delay Menu

When the DELAY button is pressed, the menu choices as shown in Table 2-6 appear (see Fig. 2-28). See "Creating Windows and Intensified Zones" under "Delayed Windows" for a complete discussion.

TABLE 2-6
Menu choices for DELAY

After Dly	View	Window1	Window2	Delay
Runs	Main	On	On	1
Trig'd	Main&Dly	Off	Off	2
	Dly			

Repeatedly touching a menu function on the screen cycles through all of the possible choices.

Intensified zones on the Main trace locate the delayed windows relative to the trigger of the Main trace. If no windows existed when powered-off, when powered-on a default choice for the delay type is **Runs After Dly**.

Since there are only two different delay references, the delay of all windows created using delay reference one are changed when delay reference one is adjusted. The same thing occurs when delay reference two is changed.

Delay—is used to assign the DELAY control knob to modify either *Delay 1* or *Delay 2*.

Window1—selections are **On** and **Off**. **On** and **Off** refer to the window and its respective intensified zone controlled by *Delay 1*.

Window2—selections are **On** and **Off**. **On** and **Off** refer to the window and its respective intensified zone controlled by *Delay 2*.

View—allows for the choice of viewing only the Main traces, only the Delayed window traces, or both Main and Delayed traces. None of these selections will affect the trace descriptions. Traces will be inhibited from view in some cases, but their trace descriptions will remain displayed.

As all of the trace descriptions are touchable at any time, selecting a trace that is inhibited will force the *View* status to **Main&Dly**. This will permit viewing of the newly selected trace.

After Dly—permits qualification of the delayed zones and sweeps. It can be set for **Runs After Dly** to immediately produce a window after the delay value expires. **Trig'd After Dly** has the added qualification of requiring a trigger from the delayed time base (e.g., the proper source, slope, and level).

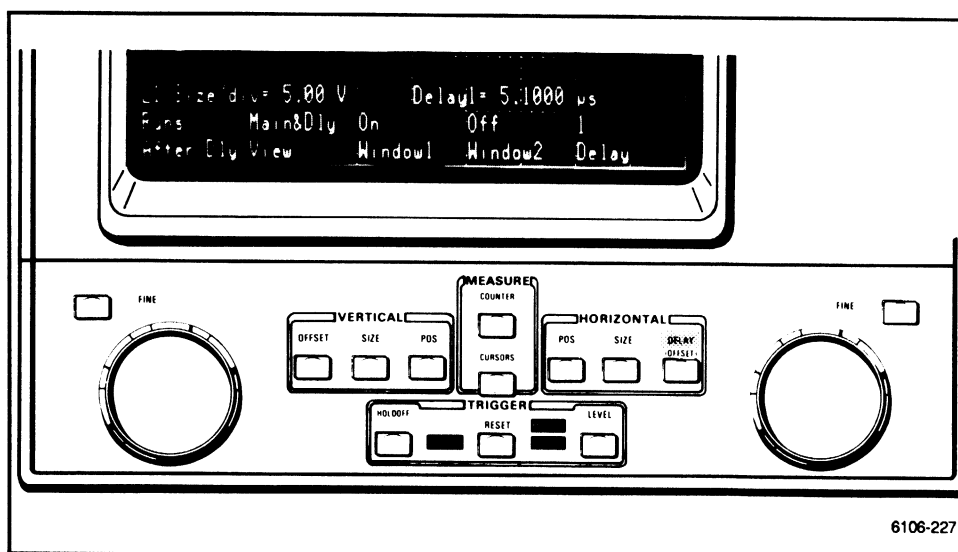

Figure 2-28. The HORIZONTAL DELAY menu for windows and YT traces.

Adjustments of the delay references are made using the DELAY control knob and selecting *Delay 1* or *Delay 2* in the menu. There are no restrictions to inhibit the selection of either one or two.

Time-Base Selection Besides the trace selection method, "Time Base Selection" is another way to designate which time base to adjust or modify in a more direct manner. The need will arise to directly specify a time base because accessing the time base indirectly through a trace description requires you to read through the list of trace descriptions to find a trace that is using the desired time base.

To select a time base you need only touch the *Time Base* choice in the Horizontal menu. When a time base is selected in this way, the oscilloscope simply alternates from the present time-base selection to the other. In addition, this direct selection implies that you prefer to bypass the selection of a trace. The selected trace remains selected.

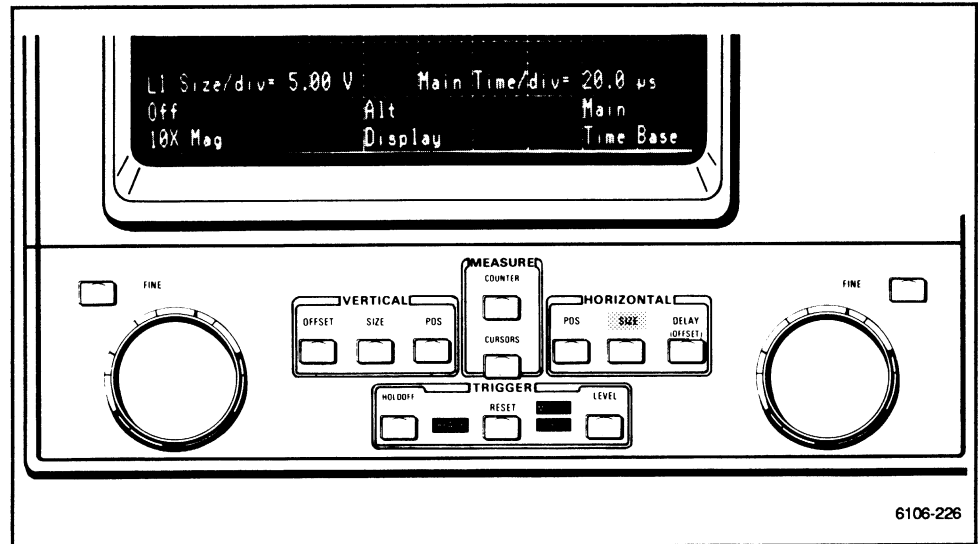

Figure 2-29. HORIZONTAL SIZE and POSition control menu for YT traces.

The menu in Figure 2-29 appears when either the HORIZONTAL SIZE or POSition button is pressed when dealing with a YT trace. In such a case, the choices for the time-base selection are **Main** or **Dly'd**. If working with an XY trace, the Horizontal menu resembles the Vertical menu and affords access to the amplifier plug-in that is driving the horizontal deflection. The components of the selected trace can be selected by touching *Chan/Time* in the menu. This selection is limited to the components of the selected trace.

When controlling an XY display, it is also necessary to select and adjust the Time/div and delay references of the time base. This requires a sharing of the horizontal controls between the time base and the horizontal deflection.

Touching *Chan/Time* will call the Time-Base menu to give control of the **Main** or **Dly'd** Time/div. The XY version of the Time-Base menu is the same as the YT version except the far right choice called *Time Base* is changed to *Chan/Time*. (See Fig. 2-30.)

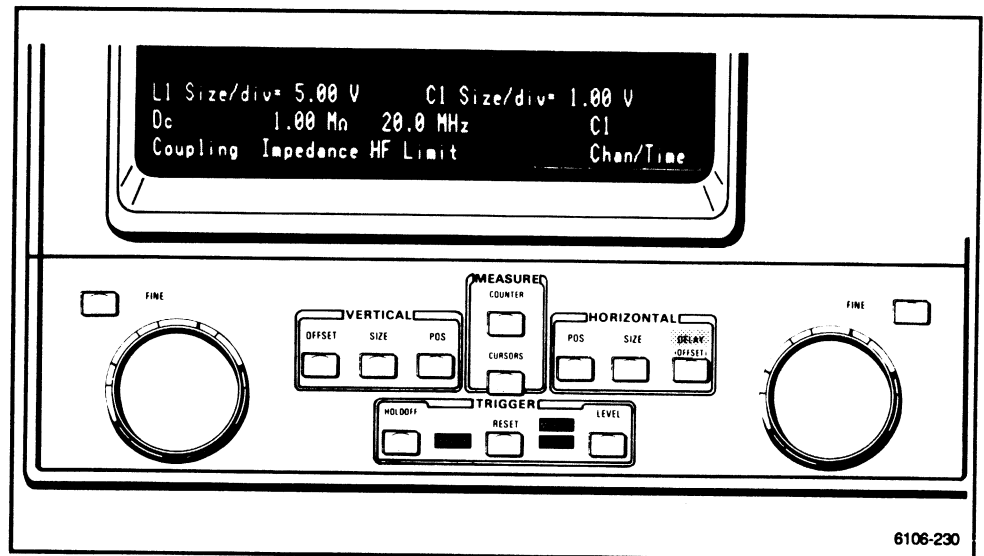

Figure 2-30. XY Horizontal Menu.

Once the time bases have been selected, the knob will remain in control of the time base function until a horizontal channel or any XY trace is selected.

Similarly, when an XY trace is selected and the DELAY button is pressed, one of the horizontal deflection channels is selected to control the offset of the amplifier. The means of accessing input offset and delay value is provided by the far right menu choice of *Chan/Dly*. The choices are the horizontal channels comprising horizontal deflection and delayed windows one and two. (See Fig. 2-31.)

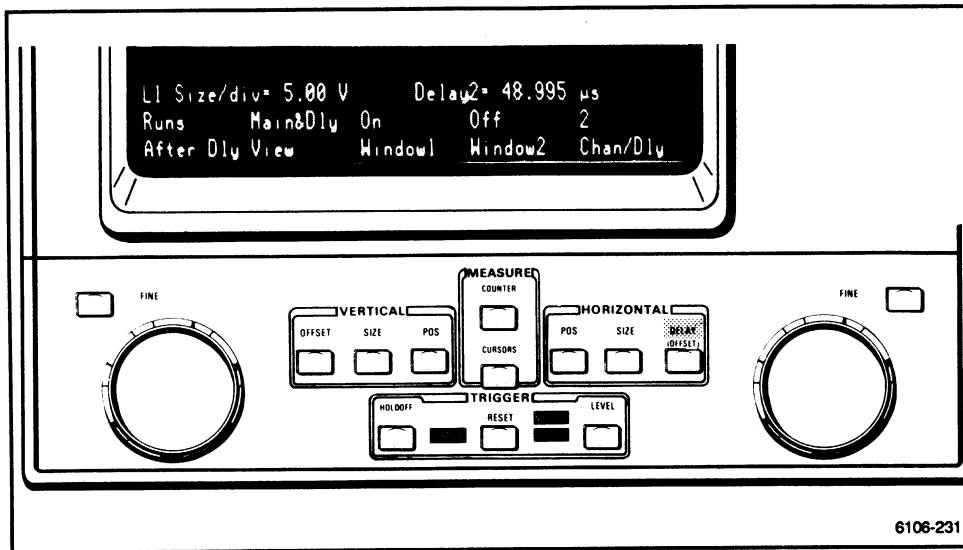

Figure 2-31. The DELAY (Offset) menu for an XY trace.

XY Traces

The menu for XY traces, shown in Figure 2-32, is similar to the vertical menu for the channel(s) providing the horizontal deflection, and it is dependent upon the type of plug-in used. It allows for selection of the two time bases as well as the input channels. See "Time-Base Selection" in this subsection.

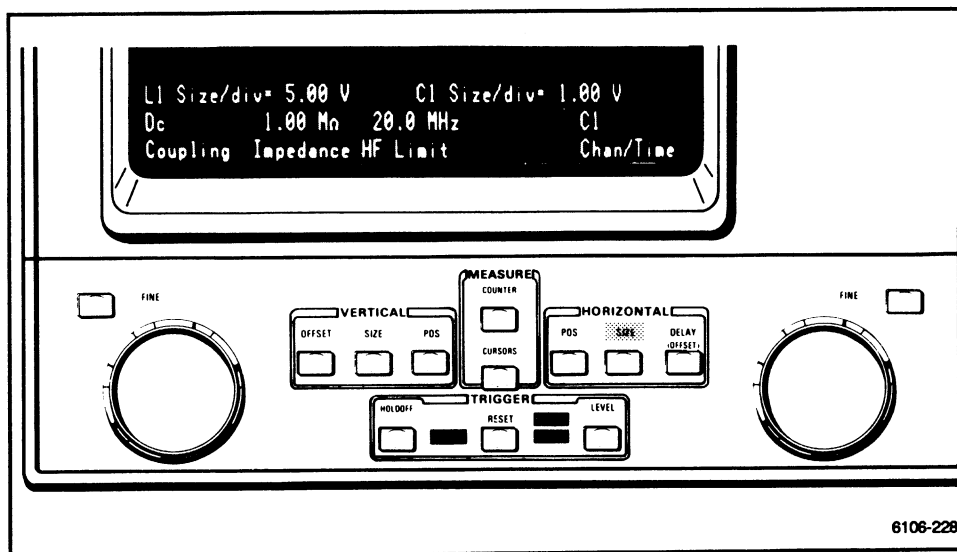

Figure 2-32. HORIZONTAL SIZE and POSition control menu for an XY trace.

YT Traces

The menu in Figure 2-33 is always displayed for YT traces using the internal time bases.

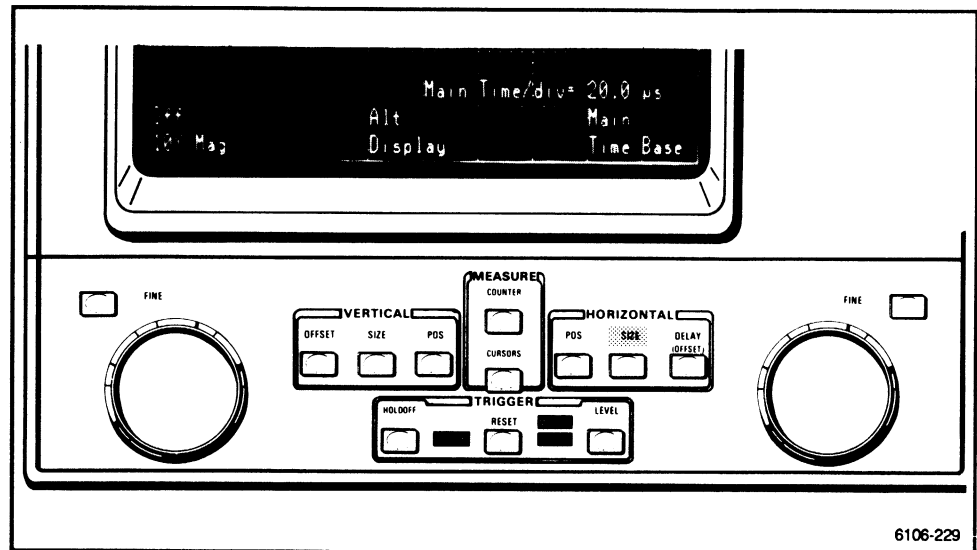

Figure 2-33. HORIZONTAL SIZE and POSition control menu for a YT trace.

Knob Behavior

Each control knob assignment has its own coarse/fine function status. The oscilloscope remembers and reinstates the coarse/fine condition for any given knob assignment. Selecting Coarse after making a FINE adjustment does not change the value of the setting. The value can be changed only by turning the knob. For any given knob assignment, the increment value of the control knob may be changed from coarse exponential to fine linear.

Delay and Offset

- Clockwise rotation increases the delay value.
- Valid coarse settings are linear increments of 0.1 division relative to the sweep speed of the Main time base. In other words, the delay time increment is one-tenth the Main time base time/division setting or 100 increments over the full sweep time of the Main time base.
- Valid fine settings are 20,000 linear increments over the 10 division range of the Main time base (2,000 increments per division).

Horizontal Position

- Clockwise rotation moves the trace to the right.
- Valid coarse (YT display, *10X Mag Off*) settings are linear increments of 0.2 divisions.
- Valid coarse (YT display, *10X Mag On*) settings are linear increments of 1 division. Remember that when using 10X Magnify, you really have 100 divisions of information, but can view only 10 at a time.
- Valid coarse (XY display) settings are linear 0.2 division increments throughout the entire range.
- Valid fine (YT display, *10X Mag Off*) settings are linear increments of 0.01 divisions.
- Valid fine (YT display, *10X Mag On*) settings are linear increments of 0.025 divisions.
- Valid fine (XY display) settings are linear 0.01 division increments.

Horizontal Size

- Clockwise rotation increases sweep speed (lowers Time/div) for YT and increases sensitivity (lowers Size/div) for XY.
- Valid coarse YT display settings are the traditional 1-2-5 sequence, exponential approximation.
- Valid coarse XY display settings are the traditional 1-2-5 sequence, exponential approximation.
- Valid fine YT display settings are linear increments of 1% of the faster coarse setting. For example, if $1 \mu\text{s} \leq \text{Time/div} < 2 \mu\text{s}$, then the increment is 10 ns (1% of 1 μs) resulting in 100 increments.
- Valid fine XY display settings depend upon the amplifier used for the horizontal deflection. Typically, they are linear increments of 1% of the lower coarse (1-2-5) step. For example, if $1 \leq \text{Size/div} < 2$, then the fine steps are 0.01(1% of 1) resulting in 100 increments.

X Offset for XY Traces (Range and resolution depend on the plug-in)

- Clockwise rotation decreases offset value.
- Valid coarse settings are determined by the plug-in.
- The fine increments are also determined by the plug-in.

Input Channel Selection (Using Probe ID)

The knob controls are assigned in two ways. The first way represents each channel input as a unique trace, thereby, allowing you to select the desired trace and manipulate it as described in "Trace Selection " in this subsection. The second way is to press the ID button on the probe for the desired channel. Assuming that the channel is being used, all occurrences of that channel are highlighted (brightened trace) in the display.

If the input is a component of the selected trace, then the trace remains selected. If the input channel is not used in the selected trace, the oscilloscope, searching left to right from the top left corner, chooses the first trace that uses the chosen input. Delayed or windowed traces are ignored in this search.

If the trace using the chosen input is an XY waveform and the input is part of the horizontal expression and Autoset is disabled, then the Horizontal controls operate upon that input channel.

If any input channel from the left or center is not in use, pressing its probe ID button creates a new trace—if there's room!—then selects it for manipulation. If there is no more room for another trace, the warning

"Channel is not displayed"

advises that this input is not or cannot be displayed, but you have control of the channel.

If the selected input is from the RIGHT compartment, VERTICAL SIZE is assigned to the knob, and the control menu of the input channel also appears. If Autoset is active, only the SIZE and OFFSET are scaled, and the time base will not be disturbed. However, as no trace is associated with the input, the trace selection is unchanged. The horizontal controls remain assigned to the selected time base. A warning advises that this input is not displayed.

Whenever a knob controls an input, the input name appears in the readout for that knob. See Figures 2-34 and 2-35.

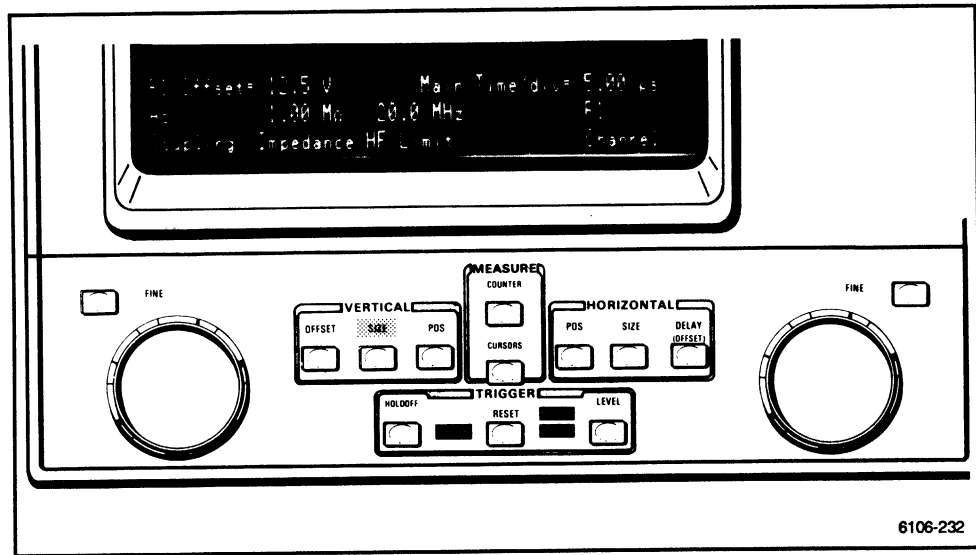

Figure 2-34. The left control knob is assigned for R1 input.

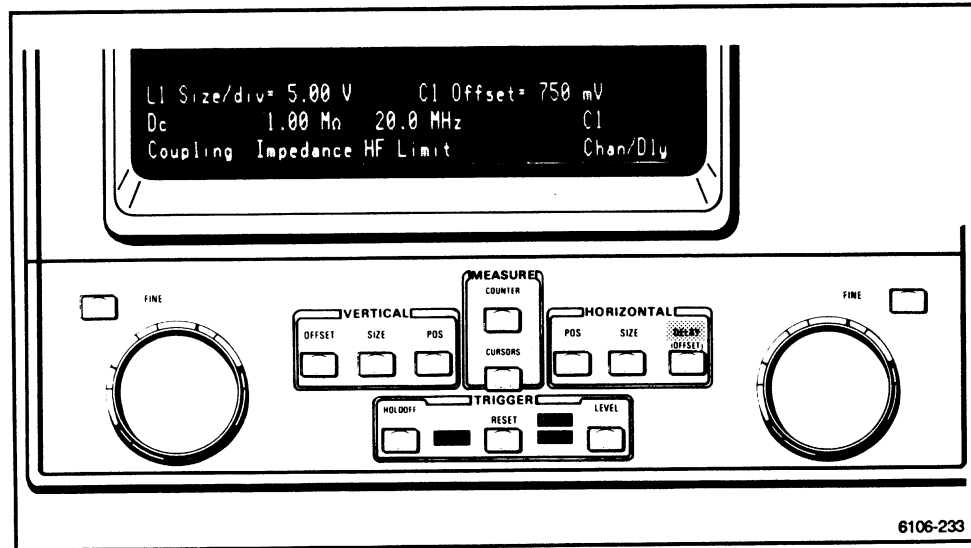

Figure 2-35. The right control knob is assigned to supply the offset for C1 even though it cannot be displayed vertically.

For an XY trace, the horizontal control knob can be assigned to an input at the same time the vertical control knob is assigned to another input.

When the probe ID button is pressed for an undisplayed left or center channel and there are eight traces already displayed, the following message is displayed:

"Channel is not displayed"

Whenever a knob controls an undisplayed input channel, the LED on the plug-in for that channel is illuminated to indicate that the channel is being controlled. If the display on/off button of an undisplayed channel is turned off, the knob reverts to controlling the last selected channel of the last selected trace.

Probe ID (Summary of Uses and Functions)

Probe ID (Identify) can be accessed through either the UTILITY menu selection *Probe ID* or by pressing the ID button on the probe body. The ID button can:

- Create New Traces
- Identify Channels in the Display
- Initiate Autoset
- Initiate Automatic Measurements
- Manually Generate a Service Request Interrupt
- Select Traces
- Sequentially Recall Stored Settings

To assign different functions to the Probe ID button, selecting *Probe ID* in the UTILITY menu offers the necessary choices (see Fig. 2-36).

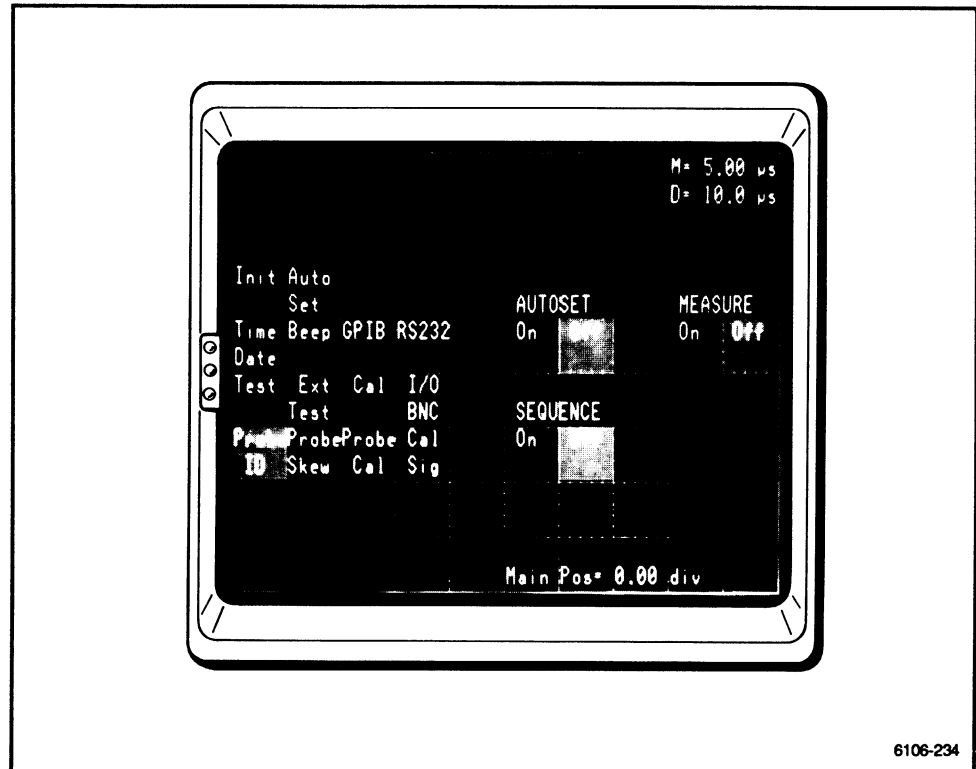

Figure 2-36. *Probe ID* selection from the Utility menu.

Create New Traces

If an input channel is not already in use, pressing its Probe ID button causes a trace to appear versus the Main time base. The WAVEFORM major menu is not required if you choose to make traces this way. This function of the ID button can be inhibited only by locking out the front panel through the GPIB or the RS-232-C interface.

Function Compatibility

All of the previously listed ID functions are compatible with each other; none exclude any others. However, there is a priority (see Table 2-7) to the execution of each function.

TABLE 2-7
Execution Priority

Execution Order	Channel Not in Use	Channel already in Use
First	Create a trace	Select a trace or channel
↓	Select a trace or channel	Sequential Recall (if enabled)
↓	Sequential Recall (if enabled)	Autoset (if enabled)
↓	Autoset (if enabled)	Measure (if enabled)
↓	Measure (if enabled)	Generate SRQ (if enabled)
Last	Generate SRQ (if enabled)	

Identify Channels in the Display and Trace Selection

If a Probe ID button is pressed for a channel that is already used for display, trace selection is made and all traces using that channel brighten momentarily. See "Trace Selection" and "Input Channel Selection" in this subsection for more detail. This function can be inhibited only by locking out the front panel through the GPIB or the RS-232-C interface.

Initiate Autoset

Automatic scaling of an input channel can be initiated by the probe ID. This function can be inhibited by turning off the Autoset feature or by locking out the front panel through the GPIB or the RS-232-C interface. See "Autoset" in this subsection for more detail.

Initiate Measurements

Automatic measurements can be initiated by the Probe ID. This is selected using the UTILITY major menu. Front-panel lockout through the GPIB or the RS-232-C interface inhibits this function. See the "Measurement" subsection for more detail.

Manually Generate a Service Request

Service request (SRQ) interrupts to the GPIB and RS-232-C interfaces can also be generated by pressing the probe ID button. This function is **not** inhibited by front-panel lockout. The SRQ is inhibited only through using the interrupt mask call PROBEID. This can be set to on or off through the GPIB or the RS-232-C interface. See Section 3, "GPIB and RS-232-C Interfaces," for more detail.

Sequentially Recalled Stored Settings

The probe ID button functions similarly to touching **Next** followed by **Recall** while in the STORE/RECALL major menu. However, when sequencing from the ID button on the probe, only locations with stored settings will be used. Any location that has been erased is skipped. To enable sequencing by the probe, you must access *Probe ID* in the UTILITY menu. There the sequencing function can be set to **On**. From any probe, the next setting in sequence can be recalled by pressing the ID button on the probe. See the "Store and Recall" subsection for more information.

Trace Selection

This oscilloscope has only one set of controls to be shared among all of the displayed traces; therefore, they operate only on the trace that has been "selected." Only one trace can be selected at a time.

Traces are constructed (defined) through the WAVEFORM major menu, the plug-in Display On/Off button, and the probe ID button. Once defined, each trace description is displayed toward the top of the screen as an expression in a unique touchable location. Touching the screen where a trace description is displayed lets you designate (select) the trace to be manipulated. The most recently created trace becomes the selected trace.

When a trace is selected, the trace description is highlighted by background shading. The corresponding trace is also highlighted by momentarily (about one second) increasing its intensity. At this point, the selected trace and its components can be manipulated using the knobs, located below the crt, and their various assignments. If you select another trace before the one second expires, the previous selection and its one second timing is abandoned in favor of the new selection. The one second delay does not inhibit the use of any controls.

Although it is intended that the knobs operate on the selected trace, it is possible that changing one trace will disturb the other displayed traces. For example, traces L1 and L1+L2 are displayed. The HORIZONTAL SIZE actually adjusts all traces using the Main time base, thereby, changing both traces. Selecting L1 and changing VERTICAL SIZE also disturbs trace L1+L2.

When a composite trace is selected, the VERTICAL SIZE and OFFSET controls are assigned to one of the input channels comprising the trace. In addition, if the selected trace is an XY trace, the HORIZONTAL SIZE and OFFSET are assigned to an input channel.

There will always be a selected channel during trace construction. This will be the last channel in the expression. When a trace is selected, the input last selected for that trace will become the selected input. If you want to adjust a component other than the one the oscilloscope picked, you can simply press the channel selection offered in the Vertical control menu or press the probe ID button for that input. However, the probe ID will cause all traces using that channel to be brightened. See "Input Channel Selection," in this subsection, for detail.

The selected trace also affects other control menus. The Horizontal control menu for a YT trace allows you to select the Main or Delayed time base for control. However, as a consequence of selecting a trace, the oscilloscope also selects the appropriate time base as well. For example, if the Delayed time base is being controlled, the oscilloscope changes the selection to the Main time base when the selected trace is displayed using the Main time base. You can still change the time base selection; however, trace selection has priority. Similarly, Triggering controls track the trace selection, but you can still override what the oscilloscope chose.

If the selected trace gets deleted, the oscilloscope selects the first trace encountered in a search from the top left to the bottom right of the trace description list. The control knobs remain active and their values undisturbed. So long as there is one or more traces defined, there will always be a selected trace. The selected trace will be changed automatically in some cases.

A parent trace refers to the main trace from which a window is derived; this trace will always exist for any window trace. The selected trace will be determined by the following conditions.

1. If the selected trace is a main trace and:
 - a. If only one window is created from this parent, that window trace will become the selected trace.
 - b. If two windows are created, the last one created will become the selected trace.
2. If the selected trace is a window and:
 - a. Same as b above.
 - b. If the selected trace is turned off by the DELAY menu, the parent trace will once again become the selected trace.

The intent of all of this is to steer other control functions like VERTICAL POSITION, TRIGGER LEVEL, and HORIZONTAL SIZE to affect the window being manipulated by the DELAY control knob.

Vertical Menu

The following is a discussion of the Vertical control menu function of SIZE, POSition, and OFFSET.

Access to Control Menus

Access to control menus occurs whenever a knob is assigned to a desired function. When another knob assignment is made, its associated menu has priority over the previous control menu and removes the old one from the display. Although the state of the previous selections are maintained, the menu itself can only be accessed by changing the knob assignment to the previous one. Knob assignments for a given knob are mutually exclusive, that is, choosing a new assignment cancels the previous one.

Vertical Size, Position, and Offset Menu

Whenever Vertical Size, Position, or Offset is pressed or the probe ID button is pressed, the control menu appears for the given channel. For details of channel selection see "Input Channel Selection" and "Trace Selection" in this subsection. The menu selection is dependent on the plug-in being used. See Table 2-8 and Figure 2-37 for the possible menu choices offered with a nondifferential amplifier.

TABLE 2-8
Possible Choices for a Nondifferential Amplifier

Coupling	Impedance	HF Limit	Channel
Ac Dc Off	1 M Ω 50 Ω	20 MHz 100 MHz 300 MHz	(Indicates which input of the plug-in is being affected by this menu. Also allows choosing the components of the selected trace.)

Repeatedly touching a menu function on the screen cycles through all of the possible choices.

Knob Behavior

Each knob assignment has its own coarse/fine function status. The oscilloscope remembers and reinstates the coarse/fine condition for any given knob assignment. Selecting Coarse after making a FINE adjustment does not change the value of the setting. The value can be changed only by turning the control knob. For any given knob assignment, the increment values of the knob may change from coarse exponential to fine linear ones.

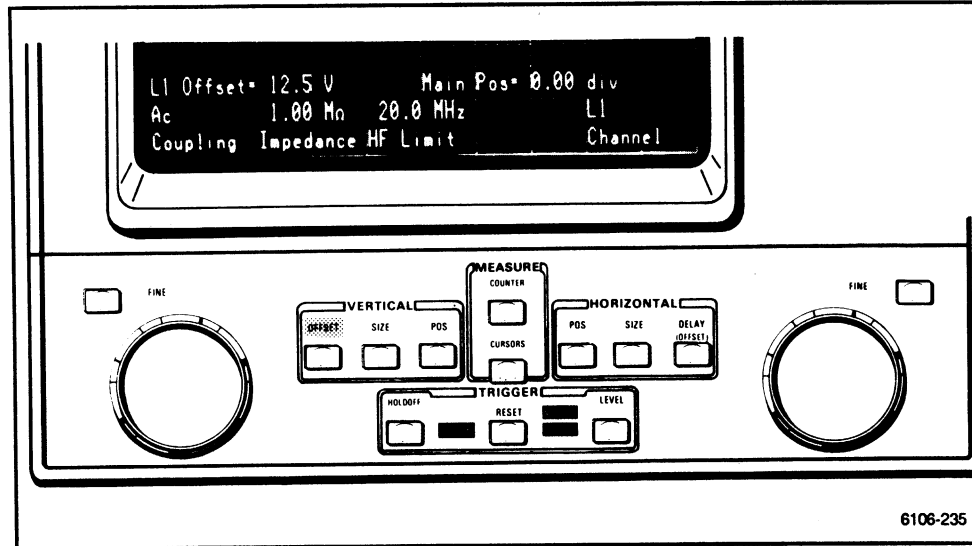

Figure 2-37. Control menu for a single-end amplifier. (See appropriate plug-in manual for exact function choices).

Vertical Offset
(Range and resolution depend on the plug-in)

- Clockwise rotation decreases offset value.
- Valid coarse settings are determined by the plug-in.
- The fine increments are also determined by the plug-in.

Vertical Position
(This is not a plug-in feature, but a main-frame display feature)

- Clockwise rotation moves the trace upward.
- Valid coarse settings are linear 0.2 division increments throughout the entire range.
- Valid fine settings are linear 0.01 division increments. An exception occurs when signals from left and center plug-ins are added. For this case, the increments are 0.02 division.

Vertical Size
(Range and resolution depend on the plug-in)

- Clockwise rotation increases sensitivity (less Volts/div).
- Valid coarse settings are the traditional 1-2-5 sequence, exponential approximation.
- Valid fine settings are linear increments of 1% of lower coarse (1-2-5) step. For example, if $1 \leq \text{Size/div} < 2$, then the fine steps are 0.01(1% of 1) resulting in 100 increments.

Waveform Menu

Traces are defined and displayed three ways. The simplest way is pressing the display on/off button of a plug-in channel, the second way is pressing the probe ID button, and the final way is choosing the WAVEFORM major menu.

Behavior of the Waveform Menu

The Waveform menu that represents the plug-in configuration presents the actual choices, not the potential possibilities. For example, if all three compartments are filled with two-channel amplifiers, the menu does not present any choices for channels 3 and 4.

As a trace is constructed, its expression appears toward the top of the display in the location determined by the oscilloscope. The oscilloscope chooses a location in one of these two ways:

1. If no traces exist, the expression of a new trace begins in the upper left corner and progresses to the right until the top locations are exhausted. After that, additional new trace descriptions appear at the left just below the first location and progress to the right. Each row has four locations.
2. If traces already exist, with descriptions occupying some of the first and second rows in the description list, and with vacancies scattered about, the oscilloscope tries to find a vacant location nearest to the top left of the display. This migration to the top of the display keeps the trace descriptions from interfering with the displayed waveforms.

Defining a New Trace with the WAVEFORM Menu

To construct a trace, press the major menu button labeled WAVEFORM. A menu like the one in Figure 2-38 appears offering several choices for trace construction.

The signals that can be displayed are categorized into three types: Counter View, Reference, and Scope (analog inputs). The organization of the menu can be explained as having a group of selections on the left side and the respective arguments and operations on the right side. In essence, there are three standard waveform menus that can be randomly selected. The presently selected one is highlighted by background shading.

Counter View

Touching *Count View* on the WAVEFORM major menu allows any or all of the Counter View signals originating from the Counter/Timer hardware to be viewed.

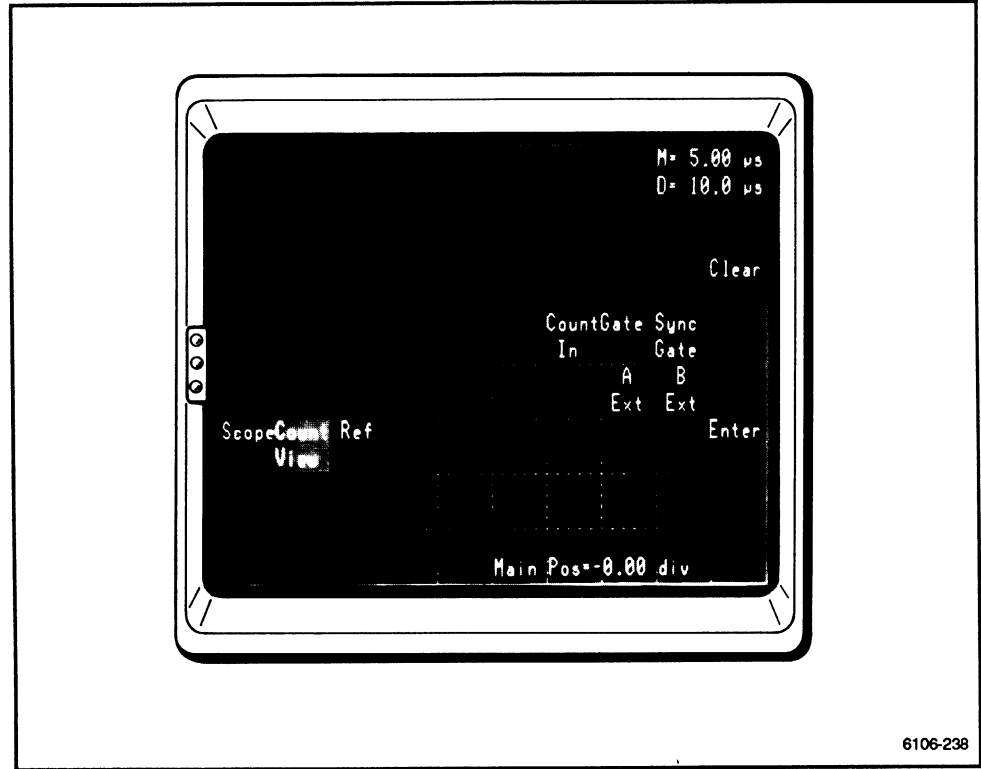

Figure 2-38. *Count View* selection in the WAVEFORM major menu.

These signals are useful in determining how the Counter/Timer is interpreting the signals it receives. There are no semantic constraints for these as they cannot interact with other signals. Any or all of the five signals can be displayed and windowed (see Fig. 2-38).

Reference

The *Ref* selection accesses waveforms that are useful for reference (see Fig 2-39). Previously stored "template" waveforms serve as references for visual comparisons. The reference waveforms can be defined by sending them into the oscilloscope from the GPIB or RS-232-C ports. The standard oscilloscope provides for two reference memories. (See "Data Transfers" in Section 3, "GPIB and RS-232-C Interfaces" for detail.

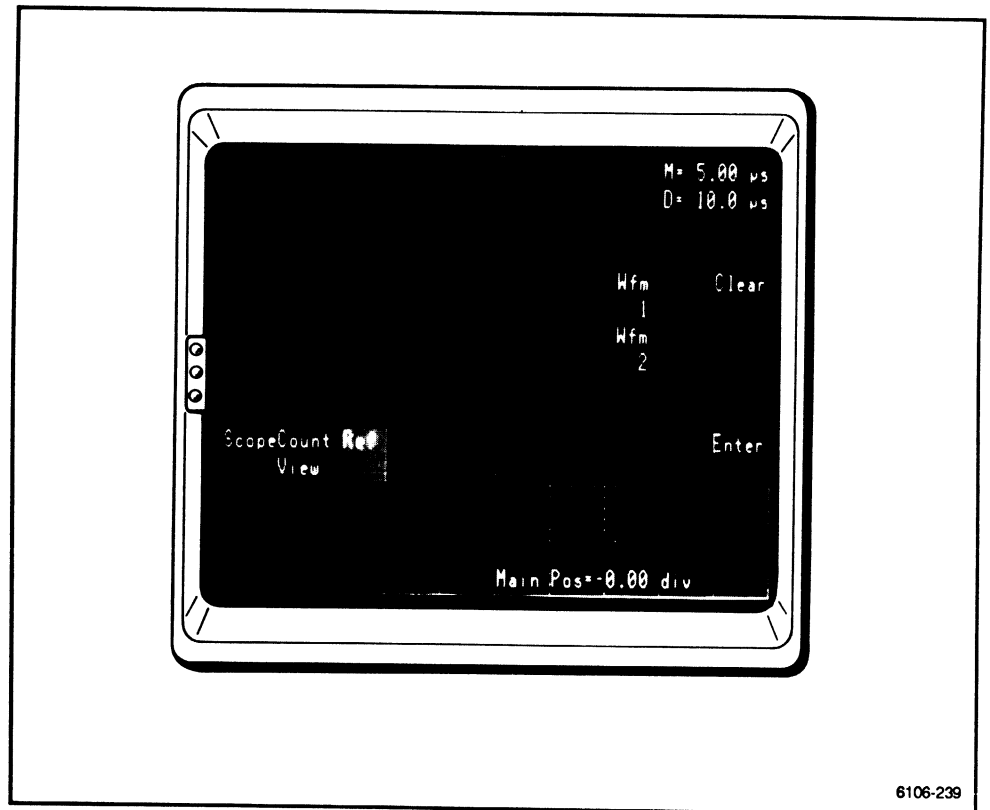

Figure 2-39. Reference selected in the WAVEFORM menu.

Scope

Selecting *Scope* permits the creation of the more traditional "analog" type oscilloscope traces. These signals use analog real-time display paths from the amplifier to the crt. Figure 2-40 represents three four-channel amplifiers installed.

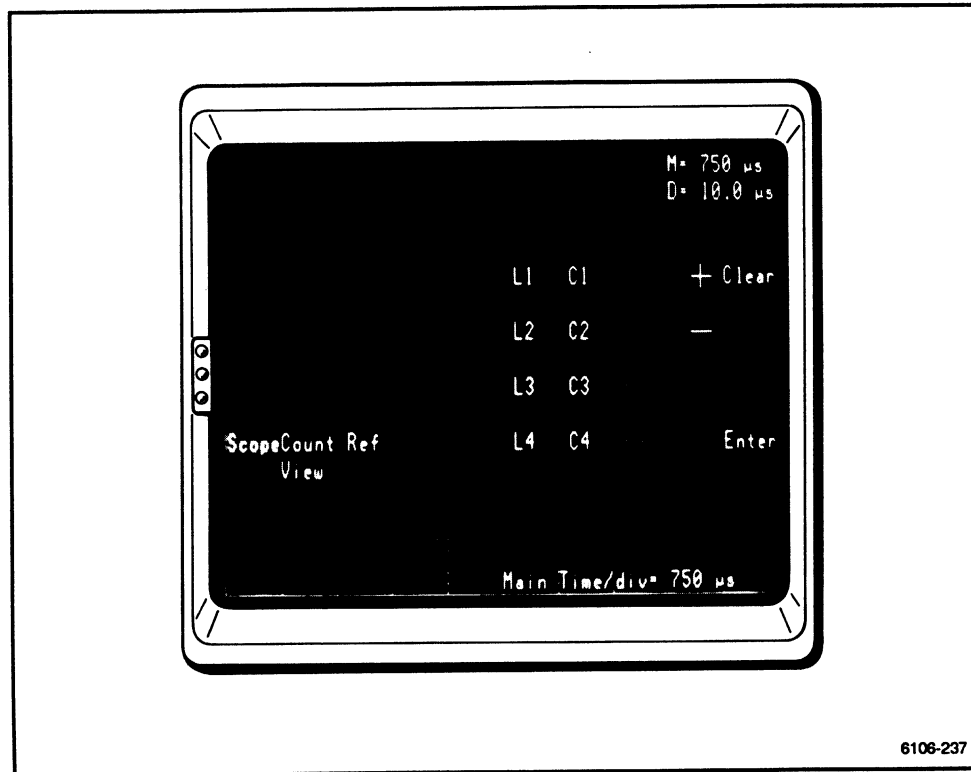

Figure 2-40. *Scope* selected in the WAVEFORM major menu.

General Trace Behavior

All trace expressions are displayed in the trace description list and any one trace can be selected by touching the desired expression. When a trace is being constructed, it is the selected trace and is highlighted by a shaded area behind the expression in the description list. At selection, the trace is momentarily brightened returning to a normal intensity after a short delay (about one second). Once selected, the trace can be controlled by the knobs and related control menu buttons.

When manipulating a composite trace (more than one channel), only one of the input channels specified in the trace is modified. See "Input Channel Selection" and "Trace Selection" in this subsection for more detail.

A blinking question-mark, used to attract your attention, indicates that the expression is under construction and the oscilloscope is waiting for more information. Upon termination, the question-mark disappears and the trace description shows the complete expression. See Figures 2-41 and 2-42.

A selected trace can be deleted (removed and no longer defined) by touching **Clear**. If the WAVEFORM major menu is exited or another waveform menu is selected without completing a trace definition, the oscilloscope accepts the most reasonable portion as a complete trace (e.g., L1+C2 Vs? would yield L1+C2 as a trace).

An individual input channel can be manipulated as if it were a separately defined trace by pressing its probe ID button. If the channel is not used in any trace descriptions, pressing the probe ID button produces a new trace. See "Input Channel Selection" in this subsection for more information.

The last item touched in a waveform menu is highlighted by a shaded background. Semantically, the item is no longer a valid choice. However, rather than dimming this choice, it is displayed with its shading. If it is touched again while it is shaded, the touch is ignored. The shading is important as it gives you feedback by showing what was touched.

When another item is touched it becomes the shaded one in the menu. Within the menu, only one argument or operator can be shaded at a time. Of course, invalid items will always be dimmed unless they are shaded. When the shading is removed from an invalid item it will then be dimmed. For example, within the *Scope* waveform menu while building the expression L1 Vs C2, the operators and operands behave as follows:

1. Touch **L1**. L1 becomes shaded and remains at normal intensity.
2. Touch **Vs**. L1 is no longer shaded and all left channel operands are dimmed. The Vs operator becomes shaded and remains at normal intensity.
3. Touch **C2**. Vs is no longer shaded and it is dimmed. C2 becomes shaded and remains at normal intensity.

If a dimmed invalid choice is touched, an error message is displayed on the prompt line. See "Errors, Warnings, and Messages" in the Appendixes for a list of messages.

Touching **Clear** when there are no traces defined results in the following message appearing on the prompt line:

"Trace does not exist"

Touching **Enter** when there is no trace being built does not cause anything to happen.

Display of Simple YT Traces (for all waveform types)

YT Displays of a single input source are the most common types and easiest to create.

One type of YT display is created simply by touching the label (trace name) for the desired source channel. The signal is immediately displayed using the main time base; this gives you feedback as the waveform shape is helpful to identify the signal.

The input label is added to a trace description list. Until **Enter** is touched (or the trace is completed as in item 4 that follows), you can touch any input source label. As each new input source is chosen, the previous one is cancelled along with its trace and description. When you are satisfied with the choice, then establish and "freeze" the trace and its trace description by touching **Enter**. The trace may also be completed by using any of the methods listed in item 4 of "Composite YT Traces" that follows.

Delayed Windows can also be created. For detail see "Delayed Windows" and "Creating Windows and Intensified Zones" in this subsection. In addition to the trace source and time base (Dly 1, Dly 2) being used, the scale factor of the input is displayed for this case of one input channel per trace.

Composite YT Traces

YT displays derived from multiple inputs require a more involved syntax. Input sources can be algebraically added or subtracted to produce a single trace. The symbols + (plus) and – (minus) are used in the expressions and shown in the trace description. To build an expression, you must use the following procedure:

1. After an input channel is designated, touching + or – begins the chain.
2. Alternately touching + and – (and vice versa) reverses the algebraic operator.
3. The input channel that is the last entry in the expression can be replaced by another input channel before the chain is completed.
4. The chain is completed by touching **Enter**, selecting a trace (including the trace being built), selecting another waveform menu, exiting the menu, creating a window from the HORIZONTAL DELAY menu, creating a trace using a plug-in display on/off button, pressing the probe ID button, or pressing the AUTOSET button.
5. Upon completion, the final item in the expression is the input channel that followed the last operator. As the expression is being constructed, it appears in the trace description list at the top of the display. The input channel added to the expression becomes the selected channel that can be manipulated by the oscilloscope controls. In other words, you can modify the latest item in the list.

The inclusion of the vertical scale factor in the trace description may exhaust the number of characters available within an individual description block. If the vertical scale factor can fit, it is displayed. Since it is possible to have a composite trace derived from inputs of different sensitivities, trace scaling becomes meaningless and will not be displayed. A vertical scale factor is displayed if the composite trace consists of two input channels that have the same sensitivity.

6. If a trace is under construction and no traces exist for a given channel when its ID or display on/off button is pressed, then the trace under construction will be completed and a new trace created and selected as derived from the button push.

Also, if a trace is under construction, a trace exists for a given channel that is not used in the constructed trace, and the display button is pressed to Off, then all the traces containing that channel will be deleted, but the current trace remains under construction.

To create the trace L1+C2 (LEFT1 + CENTER2) displayed using the Main time base, follow the procedure in Figure 2-41.

STEP NO.	TOUCH LABEL	TRACE DECIPTION
1.	L1	L1?
2.	+	L1+?
3.	C2	L1+C2?
4.	Enter	L1+C2

6106-240

Figure 2-41. Procedure for creating the trace "L1+C2."

Suppose you want to create "L1+C2", but you make a few mistakes along the way. Figure 2-40 proceeds the same as Figure 2-41, but shows how to handle accidental errors.

STEP NO	TOUCH LABEL	TRACE DESCRIPTION	COMMENTS
1.	L3	L3?	MISTAKE
2.	L2	L2?	MISTAKE
3.	L1	L1?	CORRECT
4.	-	L1-?	MISTAKE
5.	+	L1+?	CORRECT
6.	C3	L1+C3?	MISTAKE
7.	C2	L1+C2?	CORRECT
8.	Enter	L1+C2	COMPLETE

6106-241

Figure 2-42. Procedure for correcting mistakes while creating the trace "L1+C2".

Restrictions for Composite Traces (excluding XY)

- Input channels from the RIGHT compartment cannot be combined with any of the CENTER and LEFT inputs.
- The - (minus) operator cannot be used with an "empty" compartment designator for inversion or to combine two "empty" compartments (e.g., -L or L-C is not allowed).
- No more than two inputs can comprise an expression.
- Previously defined traces cannot be appended to create a new trace.
- An input appears only once in each trace description (e.g., L1-L1 is not allowed).
- An algebraic expression of two or more inputs cannot be formed by using the probe ID buttons or display on/off buttons. These buttons can create only one kind of trace: the one input versus the main time base. The trace is automatically completed.
- The RIGHT compartment cannot be used for vertical expressions.

XY Traces

XY displays are created using the **Vs** (versus) operator. Until something is specified for the horizontal displacement, the trace remains a YT trace.

If a trace is being constructed, touching **Vs** establishes it as the vertical part of the expression. Following this, the horizontal portion of the expression can be constructed under the same rules for creating composite trace expressions (this includes the prompting question mark). The pending **Vs** can be aborted while maintaining the vertical portion as a trace by touching **Enter**, selecting a trace (including the one being built), selecting another waveform menu, exiting the menu, creating a window from the HORIZONTAL DELAY menu, creating a trace using a plug-in display on/off button, pressing the probe ID button, or pressing the AUTOSET button.

The Main time base controls the duration of the XY display allowing you to examine arbitrary segments while blanking annoying bright spots common to most XY displays. This is referred to as "Triggered XY." If no trigger is detected, the XY trace will not be blanked. The Delayed time base can be used to generate intensified zones on the XY trace. This allows you to make delta-time measurements along the XY trace using the Counter/Timer. If the XY trace consists of a single input channel versus another single input channel, the vertical scale factor is displayed in its trace description block.

XY Trace Restrictions

- No input channel can be used for both vertical and horizontal displacement for the same trace.
- Vertical and horizontal sources cannot originate from the same compartment for the same trace.
- The horizontal portion of all XY traces **Vs** must use channels of the same compartment. **L1 Vs R1** and **L1 Vs C1** cannot exist simultaneously.
- The RIGHT compartment can be used only for horizontal portions of trace descriptions.
- The LEFT compartment can be used only for vertical portions of the trace descriptions.
- The horizontal displacement cannot be an algebraic expression of inputs from more than one compartment.
- Previously defined traces cannot be appended to create a new trace.
- XY traces cannot be formed by using the display on/off or probe ID buttons. These buttons can create only one kind of trace: the one input versus the Main time base. The trace is automatically completed.

NOTE

Creating an XY trace that specifies the Right Compartment as the horizontal component will result in blanking (inhibiting view only) all traces if the Right Compartment is empty.

Inverting Channel Polarity

To create a trace that is the inverted polarity of one channel, the minus operator is touched followed by the desired channel. Touching **Enter**, selecting a trace (including the trace being built), selecting another waveform menu, exiting the menu, creating a window from the HORIZONTAL DELAY menu, creating a trace using a plug-in display on/off button, pressing the probe ID button, or pressing the AUTOSET button completes the trace. This requires that the – (minus) operator be used as the first symbol of a trace description. Once the minus is used the + (plus) operator must be used to cancel the minus.

Triggering

This subsection of the Operating Instructions deals with all aspects of triggering. This subsection is divided into three main parts: TRIGGER HOLDOFF control menu, TRIGGER LEVEL control menu, and TRIGGER SOURCE major menu. The main functions are described followed by the definition or behavior of the state that each function is allowed.

Trigger Holdoff Menu

Holdoff refers to the interval when the Main time base is inhibited. During this period, any detected trigger will not start the Main sweep. This interval has been traditionally defined as some time proportional to the Time/div setting. This oscilloscope has the capability to holdoff by a time value as well as an event count. Although technically this is a type of delay, the term *Holdoff* will denote the delay of the Main time base. This is done to distinguish this function from the *Delay* associated with the Delayed time base.

When trying to view one of several pulses each having a different width, it is possible to get a display where the traces seem superimposed. This is a situation where holdoff by events is especially useful. To isolate a single pulse, holdoff can be adjusted until the holdoff interval excludes the unwanted pulses from the trigger. When the signal repeats, the time base will be triggered on the same pulse.

When the holdoff by events is used, the knob value displayed will be "Holdoff=" with no dimensions. When **Time** is used, it will be expressed in % of range (0–100%).

Holdoff Menu Selections

When the HOLDOFF button is pressed, a menu offering the choices shown in Tables 2-9, 2-10, and 2-11 are displayed.

TABLE 2-9
Holdoff Menu

	Holdoff
	Time
	2ns Step

Repeatedly touching a menu function on the screen cycles through all possible choices.

Holdoff—can be set for Time, 2ns Step, Countdown, or Events. **Time** is the conventional type derived as a percentage of the main sweep time. **2ns Step** is an event holdoff configuration that starts the holdoff with the main sweep and then counts in 1.8 ns increments. **Countdown** is another event holdoff that starts from the main sweeps and counts main triggers. **Events** offers more variety to the expert. The expert can choose which event to count, which event to start on, whether to Run or Trigger after the count, and whether to restart with each start event.

TABLE 2-10
Holdoff Previous and Next Menu

	Previous	Next	Holdoff
	Trig On	Trig On	Countdown

Repeatedly touching a menu function on the screen cycles through all possible choices.

Previous and Next—are available for Countdown. *Next* allows you to advance to the next trigger event to start the delay interval. *Previous* does the opposite. These two functions offer the convenience of stepping forward or backward within a stream of events without disturbing a critical holdoff setting.

Next and *Previous* do not have selections the control menu implies. There is no status to report as with the usual control menu selection (e.g., *Coupling= Ac, Dc, or Off*). *Next* and *Previous* always report **Trig On**; this means to trigger on the next (or previous) event. To perform a *Next* or *Previous*, the present Holdoff setting is temporarily incremented or decremented long enough to cause the trigger of the Main sweep to slip forward or backward one event. To preserve Holdoff synchronization with your signals, this temporary change exists for one sweep only; however, it also takes another sweep before the change is made. Therefore, two sweeps must pass before the beneficial effects can be observed. At slow sweep speeds and rep rates, such magic will appear sluggish.

TABLE 2-11
Holdoff Events Menu

Start	Count	One Start	After HO	Holdoff
Main Trig A Ext None	2ns Main Trig Dly Trig B Ext	On Off	Runs Trig'd	Events

Repeatedly touching a menu function on the screen cycles through all possible choices.

Start—choices determine which event will begin the holdoff interval. This signal must be less than 100 MHz.

Count—offers the choice of which event to count in order to include the Holdoff interval.

One Start—allows for restarting the holdoff count only with the recurrence of the start event (*One Start Off*) or to automatically restart the count at the termination of the count (*One Start On*). For *One Start On*, the start event need only occur once.

After HO—allows for the main sweep to run immediately after holdoff (*Runs After HO*) or to wait for a trigger after holdoff (*Trig'd After HO*).

To define each Holdoff choice in hardware combinations, Table 2-12 supplies a translation.

TABLE 2-12
Holdoff Operation

Holdoff	Description
Time	Time is proportional to Main Time/div. Duration of ≈ 1 to $20X$ Time/div ($2.5 \mu\text{s}$ minimum).
2ns Step	Main Sweep is held off by events where the Start Event=Main Sweep, the Counted Event=2 ns (1.8 increments), and the time base is triggered after the holdoff interval. The holdoff interval spans the Main sweep and sweep reset time.
Countdown	The Main Sweep is held off by events where the Start Event=Main Sweep, the Counted Event=Main Trigger, and the time base runs immediately after the holdoff interval. The holdoff interval spans the Main sweep and sweep reset time.
Events	<p>The caldron where a plethora of choices abound. Here is where the expert will find sanctuary, and the brave novice will be tested.</p> <p>The holdoff interval occurs at the completion of the Main sweep and the sweep reset time. The Start Event=Main Trigger or A Ext; the Counted Event=2 ns (1.8 ns increments), Main Trigger, Delay Trigger, or B External; and the Main sweep can Run After or wait to be Triggered After the holdoff interval. The holdoff interval can be automatically started when the count has expired (One Start=On) or it can wait for another Start event (One Start=Off).</p>

Knob Behavior when using Holdoff

Main Holdoff by Events and Countdown

- Valid coarse settings are linear increments of 100 within a total range of 1 to 2^{29} .
- Valid fine settings are linear increments of 1.

Main Holdoff by 2ns Step

- If Main sweep speed is <200 ns, then coarse increments are 1.8 ns. Otherwise, coarse increments are 1% of current coarse Main Time/div increment.
- Fine increments are 1.8 ns.

Main Holdoff by Time

- Valid coarse settings are 1%.
- Valid fine settings are 0.01%.

Restrictions for Holdoff

- When using *Holdoff=2ns Step* or *Holdoff=Countdown*, the minimum setting is dependent upon the Main Time/div setting. See Table 2-13.

If this restriction is violated, the time bases will no longer operate. To resume normal operation, either

- a. enter a valid holdoff setting from the NUMERIC ENTRY major menu, or
 - b. turn the holdoff knob to a valid setting and then press the TRIGGER RESET button.
- P-P mode and Auto trigger are not recommended for Holdoff by Events or Countdown. The following message appears:
"Use Norm trigger mode for best results"
 - When using *Holdoff=Countdown*, creation of holdoff time shorter than the minimum settings shown in Table 2-13 may cause the sweeps to stop. Changing the Main sweep speed or pressing RESET will restart the sweeps. For continued operation, the holdoff time must be set to meet or exceed the minimum time.

One Start—allows for restarting the holdoff count only with the recurrence of the start event (*One Start Off*) or to automatically restart the count at the termination of the count (*One Start On*). For *One Start On*, the start event need only occur once.

Count—offers the choice of which event to count in order to comprise the Holdoff interval.

Start—choices determine which event will begin the holdoff interval. This signal must be less than 100 MHz.

To define each Holdoff choice in hardware combinations, Table 2-12 supplies a translation.

TABLE 2-12
Holdoff Operation

Holdoff	Description
Time	Time is proportional to Main Time/div. Duration of ≈ 1 to $20X$ Time/div ($2.5 \mu\text{s}$ minimum).
2ns Step	Main Sweep is held off by events where the Start Event=Main Sweep, the Counted Event=2 ns (1.8 increments), and the time base is triggered after the holdoff interval. The holdoff interval spans the Main sweep and sweep reset time.
Countdown	The Main Sweep is held off by events where the Start Event=Main Sweep, the Counted Event=Main Trigger, and the time base runs immediately after the holdoff interval. The holdoff interval spans the Main sweep and sweep reset time.
Events	<p>The caldron where a plethora of choices abound. Here is where the expert will find sanctuary, and the brave novice will be tested.</p> <p>The holdoff interval occurs at the completion of the Main sweep and the sweep reset time. The Start Event=Main Trigger or A Ext; the Counted Event=2 ns (1.8 ns increments), Main Trigger, Delay Trigger, or B External; and the Main sweep can Run After or wait to be Triggered After the holdoff interval. The holdoff interval can be automatically started when the count has expired (One Start=On) or it can wait for another Start event (One Start=Off).</p>

Knob Behavior when using Holdoff

Main Holdoff by Events and Countdown

- Valid coarse settings are linear increments of 100 within a total range of 1 to 2^{29} .
- Valid fine settings are linear increments of 1.

Main Holdoff by 2ns Step

- If Main sweep speed is <200 ns, then coarse increments are 1.8 ns. Otherwise, coarse increments are 1% of current coarse Main Time/div increment.
- Fine increments are 1.8 ns.

Main Holdoff by Time

- Valid coarse settings are 1%.
- Valid fine settings are 0.01%.

Restrictions for Holdoff

- When using *Holdoff=2ns Step* or *Holdoff=Countdown*, the minimum setting is dependent upon the Main Time/div setting. See Table 2-13.
- P-P mode and Auto trigger are not recommended for Holdoff by Events or Countdown. The following message appears:

"Use Norm trigger mode for best results"
- When using *Holdoff=Countdown*, creation of holdoff time shorter than the minimum settings shown in Table 2-13 may cause the sweeps to stop. Changing the Main sweep speed or pressing RESET will restart the sweeps. For continued operation, the holdoff time must be set to meet or exceed the minimum time.

TABLE 2-13
Minimum Holdoff Time for 2ns Step and Countdown

Main Time/div	Minimum Holdoff
5 ns to 50 ns	3.50 μ s
>50 ns to 100 ns	4.30 μ s
>100 ns to 200 ns	5.50 μ s
>200 ns to 500 ns	9.80 μ s
>500 ns to 1 μ s	16.0 μ s
>1 μ s to 2 μ s	30.0 μ s
>2 μ s to 5 μ s	78.0 μ s
>5 μ s to 10 μ s	160 μ s
>10 μ s to 20 μ s	300 μ s
>20 μ s to 50 μ s	780 μ s
>50 μ s to 100 μ s	1.60 ms
>100 μ s to 200 μ s	3.00 ms
>200 μ s to 500 μ s	7.80 ms
>500 μ s to 1 ms	16.0 ms
>1 ms to 2 ms	30.0 ms
>2 ms to 5 ms	78.0 ms
>5 ms to 10 ms	160 ms
>10 ms to 20 ms	300 ms
>20 ms to 50 ms	780 ms
>50 ms to 100 ms	1.60 s ¹
>100 ms to 200 ms	3.00 s ¹
>200 ms to 500 ms	7.80 s ¹
>500 ms	20.0 s ¹

¹Applies only to Countdown.

Restrictions for Holdoff by Events

The following restrictions apply only when *Holdoff=Events*.

- *Start=None* and *One Start=On* are incompatible. To avoid this:
 1. If *Start=None* and *One Start* is selected to be **On**, then *Start* will be forced to **Main Trig** with the following crt/GPIB/RS-232-C warning.
 "Start is Main Trig—One Start needs a Start Event"
 2. If *One Start=On* and *Start* is selected to be **None**, then *One Start* will be forced to **Off** with the following crt/GPIB/RS-232-C warning.
 "One Start forced to Off"

- *One Start=On* and *Count=2ns* are incompatible. To avoid this:
 1. If *One Start=On* and *Count* is selected to be **2ns**, then *One Start* will be forced to be **Off** with the following crt/GPIB/RS-232-C warning.

"One Start forced to Off"
 2. If *Count=2ns* and *One Start* is selected to be **On**, then *Count* will be forced to **Main Trig** with the following crt/GPIB/RS-232-C warning.

Trigger Level Menu

The input signal of the oscilloscope may have a wide variety of shapes and amplitudes. The trigger controls allow you to select any voltage level on the rising or falling slope of the waveform and, in some instances, filter out selected frequencies of the input signal.

Menu Selections

The functions and function status occupy touch zones (see Fig. 2-43). Touching one of these zones selects a new state for the indicated function. For instance, if *Coupling* is touched, this state changes from **Ac** to **Dc**. If *Sensvty* (sensitivity), *Mode*, or *Slope* is touched, the selected function cycles through the possible states. Tables 2-14 through 2-16 list all possible states for each trigger function in the control menu.

TABLE 2-14
Trigger Level Menu Functions and States

Mode	Coupling	Sensvty	Slope	Trigger
P-P	Ac	High	+	Main
Auto	Ac Lf Rej	Medium	-	
Norm	Ac Hf Rej	Low		
Single	Dc			
	Dc Hf Rej			

Repeatedly touching a menu function on the screen cycles through all possible choices.

TABLE 2-15
Trigger Delay Choices

	Coupling	Sensvty	Slope	Trigger
	Ac	High	+	Dly1 Dly2
	Ac Lf Rej	Medium	-	
	Ac Hf Rej	Low		
	Dc			
	Dc Hf Rej			

Repeatedly touching a menu function on the screen cycles through all possible choices.

TABLE 2-16
External Trigger Choices

	Slope	Trigger
	+	CT EXT A
	-	CT EXT B

Repeatedly touching a menu function on the screen cycles through all possible choices.

Menu Selection Definitions

Triggering controls are accessed through the knob assignment button called TRIGGER LEVEL, located between the control knobs (see Fig 2-1, Front-panel illustration).

Source Coupling—selects the coupling, either **Ac** or **Dc**, for the selected source. If the input source is ac coupled, dc coupling probably won't mean a lot; however, it won't be excluded. Dc coupling with LF Reject is not allowed.

Ac—blocks the dc component of the trigger signal and reliably passes signals with frequency >50 Hz.

Dc—passes signals of 0.0 Hz to maximum system bandwidth.

Ac Low-Frequency Rejection—rejects dc and attenuates low-frequency trigger signals below about 80 kHz.

Ac High-Frequency Rejection—rejects dc and high-frequency signals above 30 kHz.

Dc High-Frequency Rejection—rejects high-frequency signals above 30 kHz, while retaining the dc component of the trigger signal.

Trigger Sensitivity—selects low, medium, or high sensitivity for the trigger comparator.

Low—requires the greatest peak-to-peak swing of the trigger signal to produce a trigger. This is helpful in reducing the effects of noise on the trigger stability.

High—requires the smallest peak-to-peak swing to produce a trigger. This is most helpful in reducing hysteresis errors found in Width measurements.

Medium—is a compromise between Low and High.

Mode—selects P-P, Auto, Single, and Normal. The Dly1, Dly2, CT Ext A, and CT Ext B trigger have only **Normal** mode and do not offer this selection.

P-P—seeks and maintains a triggered trace by keeping the trigger level within the peak-to-peak amplitude of the trigger source signal. You have the freedom to modify the trigger level at will; the oscilloscope, however, will not let the level be set beyond the peak-to-peak range of the signal.

If the trigger signal changes such that triggering is lost, the oscilloscope attempts to reestablish a triggered trace by searching for a new trigger level. This continues indefinitely until a triggered display is restored. While searching, the trace "free-runs" until triggered.

If the signal is too small to trigger on, it's up to you to either boost the gain, select a different source, or invoke Autoset. P-P Auto does not invoke Autoset or modify the signal gain and offset. The time-out value to determine whether the trigger is present allows for trigger repetition rates of >30 Hz while waiting long enough to complete one full sweep if free-running. Do not use P-P for signals less than 30 Hz.

Auto—is the same as Normal except that when there's nothing to trigger on, the sweeps are forced to "free-run." Assuming a free-running sweep, the trigger time-out value allows for a repetition rate of >30 Hz while waiting long enough to complete a full sweep. Do not use Auto for signals less than 30 Hz.

Normal—is totally a manual process. You must set the level as desired. If the oscilloscope can't be triggered under the conditions imposed, you will not get a sweep.

Single sequence—is referenced in "Single (Sequence) and Trigger Reset" in this subsection.

Slope—selects the edge sensitivity of the trigger event. Either + or - is available.

Trigger Select—allows the trigger choice to be modified. The selectable triggers are Main, Dly1 (delayed window 1), and Dly2 (delayed window 2), CT Ext A, and CT Ext B. Each time a trace is selected, the oscilloscope matches the trigger to the corresponding time base. You have the option to manually override the choice of the oscilloscope.

Each function and its present status appears at the bottom of the display. Repeated touching of the label cycles through all possible states.

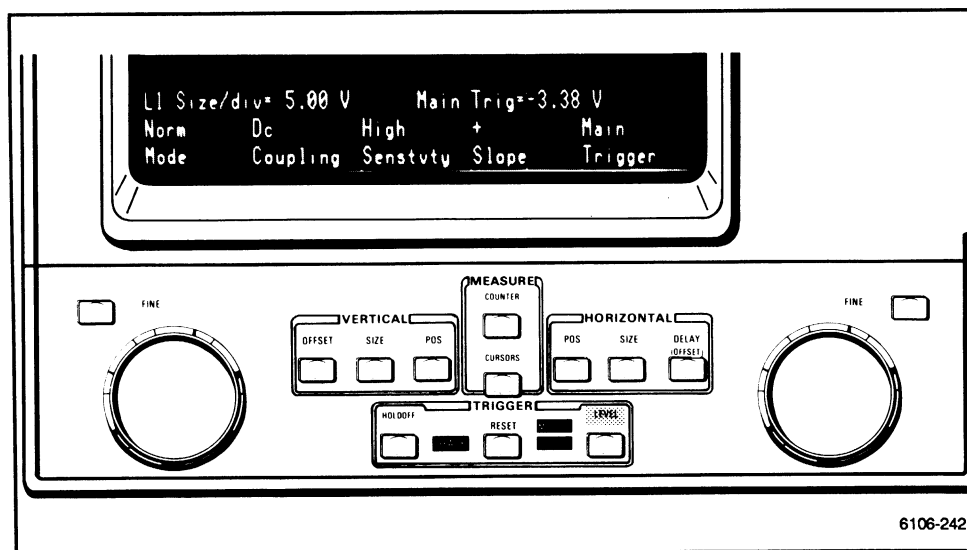

Figure 2-43. The TRIGGER LEVEL control menu and status.

Trigger Level Knob Behavior

- Clockwise rotation increases the level value.
- Valid coarse settings are 0.1 divisions.
- Valid fine settings are 0.01 divisions.

Trigger Scaling

The display value for the trigger level is scaled in divisions or in the dimensions given by the trigger source (e.g., Volts, Amp, etc.). See Figure 2-43. If the Trigger source is ac coupled anywhere along its path (either mainframe or plug-in), the trigger level dimension will have the prefix "ac". If the entire trigger path is dc coupled, then the level is scaled to the sensitivity and dimensions of the source.

If the path is dc coupled, each time the sensitivity or offset of the source changes the scaled trigger level will also change. The actual hardware setting of the trigger level will not be disturbed.

If the trigger source is a single inverted channel (e.g., -L1) or two inverted channels (e.g., -L1 -L2), then the polarity of the trigger level readout will be inverted. If the trigger expression is composed of multiple sources, then divisions are used to scale the trigger level. If using divisions for the Size/div scaling, 0.0 div Trigger Level will be located at center screen. If the trigger path is dc coupled, then the offset and sensitivity of the source will be used for scaling in the same way as the cursors. Trigger level range is ± 10 divisions.

The scaling for the CT Ext A and B levels is always in volts and doesn't have to deal with offset or Size/div; however, probe attenuation coding is included.

NOTE

***EXT+5** and **EXT** source selections interact with the trigger level scaling when dc coupled. **EXT+5** means the trigger sensitivity is reduced by a factor of 5. For example, if the Trigger Level=0.08 V with **EXT**, the Trigger Level=0.4 V with **EXT+5**.*

Trigger Source Major Menu

The TRIGGER SOURCE major menu allows you to specify the signals on which to trigger. This menu offers all the available sources for the Main, Dly1, and Dly2 triggers; the input sources from the vertical amplifiers; the A and B External input of the mainframe; and the ac line signal. Whenever a new source is desired, the old trigger can be replaced by touching any other valid source. (See Fig. 2-44.)

About Defining Trigger Sources

The triggers are defined on the left side of the display, and the available arguments are on the right side. (See Table 2-17.) Touching a trigger name Main, Dly1, or Dly2 presents the valid arguments for that trigger. As choices or expressions are made, they are implemented immediately to lend feedback. This is similar to making traces in that you may interact and respond to the current behavior of the instrument rather than wait until the expression is terminated. Each new selection cancels the previous one. The sources used are indicated by written description.

The trigger expression or definition is always displayed when the TRIGGER SOURCE major menu is displayed. Only one trigger definition can be designated for each time base. Alternate switching of the Main time-base trigger source is not available.

NOTE

*As the hardware provides for only two independent time-base triggers, Main and Delayed, it is required that the delayed trigger be alternated to permit independent selection of trigger slope, source, and level for the two delayed windows. Therefore, the TRIGGER SOURCE major menu appears to present three independent trigger source definitions, one main and two delayed (Dly1 and Dly2). (See Fig. 2-45.) As a consequence, if no traces exist or only traces using the Main time base exist, the trigger source, level, and slope for Dly1 trigger will be active with the expression for Dly2 trigger unused. Dly2 trigger will only be implemented when delayed window number two (Window2=**On**) is in use. The trigger expression for Main will always be active.*

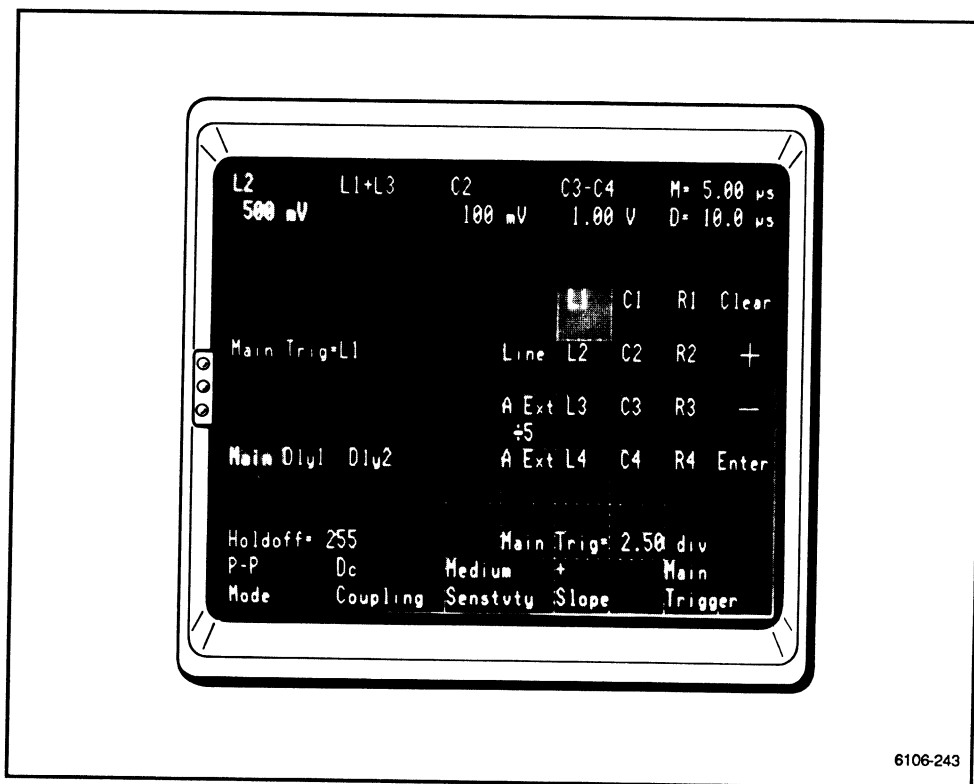

6106-243

Figure 2-44. TRIGGER SOURCE major menu plus TRIGGER control menu.

TABLE 2-17
Trigger Source Selection and Choices

Trigger	Choices
Main	L, C, R, Line, A Ext+5, A Ext, +, -, Clear, Enter
Dly1	L, C, R, Line, B Ext+5, B Ext, +, -, Clear, Main Trig, Enter
Dly2	L, C, R, Line, B Ext+5, B Ext, +, -, Clear, Main Trig, Enter

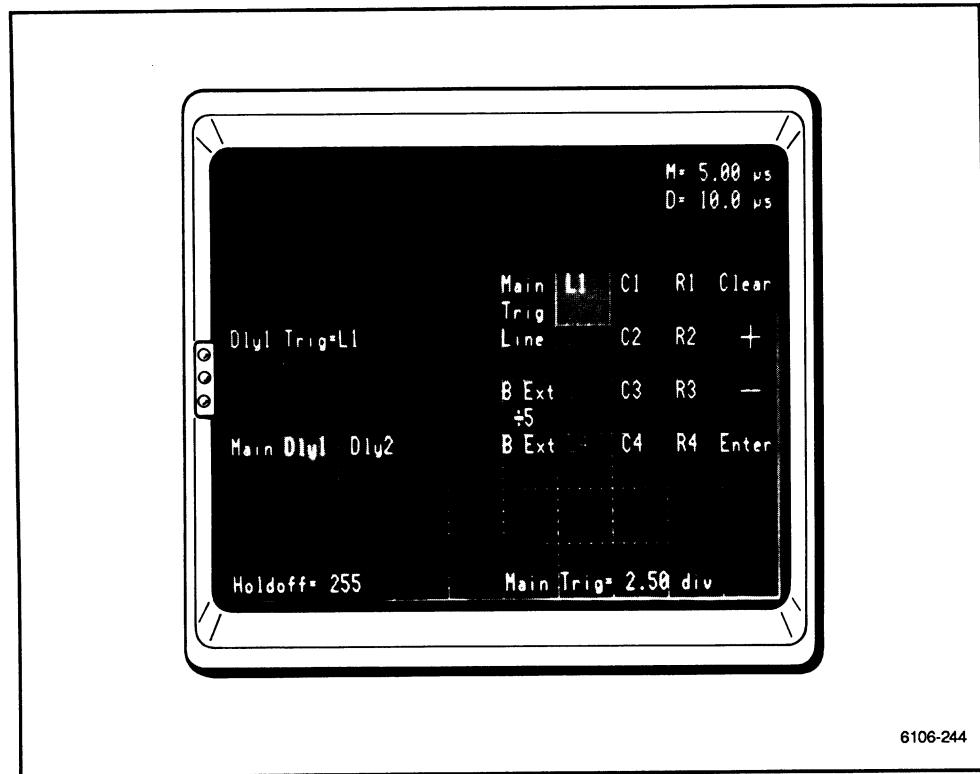

Figure 2-45. This example shows the selections (right half of menu) available for the *Dly1* trigger source. The *Dly2* trigger source menu offers the same selections.

Choices of Trigger Sources

Main Time-Base Sources

- Any combination of channels from the LEFT and CENTER compartments
- Any combination within the RIGHT compartment
- The ac-line signal of the mainframe
- The A External input of the mainframe
- The A External with 5X attenuation

Delayed (Dly1 and Dly2) Time Bases

- Any combination of channels from the LEFT and CENTER compartments
- Any combination within the RIGHT compartment

- The ac-line signal of the mainframe
- The B External input of the mainframe
- The B External with 5X attenuation
- The same as the Main Trigger expression (except Ext inputs)

NOTE

*Dly1 and Dly2 have independent slope, level, and source expressions.
Coupling and Sensitivity are not independent.*

Creating Trigger Source Expressions for Main and Delayed Triggers

Menus that represent the plug-in configuration will present the actual available choices, not the potential possibilities. For example, if all three compartments are filled with two-channel amplifiers, none of the menus will present choices for channels 3 and 4.

Trigger Source Restrictions

The trigger sources derived from the plug-ins can be only one expression. This places a limitation on the available valid sources to the Main and Delayed triggers. As the delayed triggers are referenced to the occurrence of the main sweep, the source within the plug-in cannot be switched quickly enough to provide the delayed trigger with a reliable signal. Therefore, the choices for the delayed trigger sources depend upon the *Main* trigger source selection.

If the Main trigger source is an expression from one plug-in, this expression is the only valid one that both of the delayed sources can use from that plug-in. Any other sources that do not originate from the same plug-in used by the Main trigger are valid. Invalid choices are dimmed.

As a result of defining a new Main trigger source, a previously defined Delayed trigger source may now be invalid. When this occurs, the affected Delayed trigger source is automatically changed to match the new Main trigger source. One of the following three errors will be reported when this happens.

"Delayed trigger source #1 has been changed"

"Delayed trigger source #2 has been changed"

"Delayed trigger sources #1 and #2 have changed"

If an invalid choice that is dimmed is touched, an error message is displayed on the prompt line. See "Errors, Warnings, and Messages" in the Appendixes for a list of possible messages.

Expressions for Composite Triggers for Main and Delayed Triggers

Input sources can be algebraically added or subtracted to produce a trigger expression. The symbols + (plus) and – (minus) are used in the expressions. When building an expression, the following rules apply:

1. The last input channel chosen prior to touching + or – becomes the first element of the chain.
2. Alternately touching + and – (and vice versa) reverses the algebraic operator.
3. The input channel that is the last entry in the expression can be replaced by another input channel before the chain is completed.
4. The chain is completed by touching **Enter**, selecting another trigger source menu, exiting the menu, creating a window from the HORIZONTAL DELAY menu, running Autoset using probe ID or front-panel button, or creating a trace using the probe ID or plug-in display on/off button.
5. Upon completion, the final item in the expression is the input channel that followed the last operator. As the expression is being constructed, it appears above the menu selections on the left side of the screen.

A blinking question-mark, used to get your attention, indicates that the expression is under construction and the oscilloscope is waiting for more information. Upon termination, the question-mark disappears showing the complete expression.

6. Touching **Clear** will erase the current trigger source expression and cause the trigger source to be undefined.

Composite Trigger Restrictions

- Input channels from the RIGHT compartment cannot be combined with any of the CENTER and LEFT inputs.
- No more than two inputs can comprise an expression.
- **Ac Line**, **Ext**, and **Ext+5** cannot be used in a composite expression.
- Previously defined expressions cannot be appended to create a new one.
- An input appears only once in each trigger description (e.g., L1–L1 is not allowed).

Inverting Channel Polarity

To create a simple trigger expression that is the inverted polarity of one channel, the minus operator is touched followed by the desired channel. If exited before creating an expression (- or + does not abort the prior trigger expression), the old one is used and the following message is given in the prompt line.

"Incomplete Trigger expression aborted"

Pending Source Definition

A special case occurs when the oscilloscope attempts to create a trigger source when all traces have been deleted pending the definition of new ones. In such a case, it is possible that an old trigger source definition can be confusing because it may not be obvious why the newly created trace won't trigger! To avoid this possible trap, the oscilloscope chooses a source for you.

When all oscilloscope traces are deleted, the oscilloscope is in a "trigger source pending" state. Count View and Ref waveforms do not affect "trigger pending." If you then decide to define a Main or Delayed trigger from the TRIGGER SOURCE menu, "trigger pending" is cancelled and the oscilloscope does **not** attempt to automatically create a trigger source definition.

If, however, you do not directly create a trigger definition, the oscilloscope creates a trigger source and cancels the "trigger source pending." The source selected for the main and two delayed triggers is the same as the vertical component of the trace that you selected in the process of defining a trace.

Single (Sequence) and Trigger Reset

Single Sequence

When armed (ready) and properly triggered, Single sequence will provide one complete display of all analog "Scope" traces. If there is more than one "Scope" trace displayed and Holdoff is set for Time, multiple triggers are required to complete one display sequence. This is true regardless of CHOP, ALT, or AUTO display choices. One Main trigger is required for each trace using the Main time base. An additional Main trigger is required for each Window2 trace present. Also, if a Window traces exists with the Dly'd time base set for Trig'd After Dly and the Dly'd trigger event does not occur while the Main time base is sweeping, the delayed time base will not run. Hence, the Window trace(s) will not be displayed.

Once the number of Main trigger events is satisfied, Single sequence will complete successfully. Pressing the TRIGGER RESET button resets or reloads the Counter/Timer and Holdoff for a fresh count. The sweeps and triggers of the time bases are armed awaiting a trigger.

Use caution when using Events or Countdown Holdoff as these also require multiple trigger events.

Because Single sequence is nearly always used with long and indefinite photographic exposure times, the TRIGGER RESET button disables all readout text and graticule lights until the trigger events complete the sequence. Because the readout is disabled, all touch screen choices are disabled. The readout and the graticule are momentarily pulsed (approximately 100 ms) at the end of the sequence to record the text and graticule onto the film.

To restore the oscilloscope to its prior state, you may touch the screen or any button on the oscilloscope. If the screen or button is touched, the oscilloscope aborts the single sequence operation without executing any additional functions.

When not in the Single sequence mode, the TRIGGER RESET still functions, but it does not disable the display or impair any other oscilloscope functions.

Trigger RESET

Pushing the trigger RESET button on the front panel or a high-to-low transition at the rear panel TRIGGER RESET connector produce the same results. Upon Reset, the counter aborts and restarts its measurement and holdoff-by-event count. The sweeps will be interrupted and aborted and the triggers rearmed. For the interval from triggers rearming to the sweeps starting again, the READY light on the front panel will be illuminated. Whenever the READY light is on, the rear panel TRIGGER READY output will be set to a high state. When the READY light is off, the TRIGGER READY output will be set to a low state.

Triggered After Delay

Selection and control of the delay value and type of the delayed window are made through the Horizontal control menu. (See Fig. 2-46.) This appears whenever the HORIZONTAL DELAY button is pressed. See "Waveform Acquisition" and "Delayed Windows" for additional information.

If *Runs After Dly* is used, the delayed windows from the horizontal menu are forced to "run" immediately after a specified delay. If *Trig'd After Dly* is selected, the delayed windows will not appear until a trigger is detected after the delay has expired but before the end of the main sweep time.

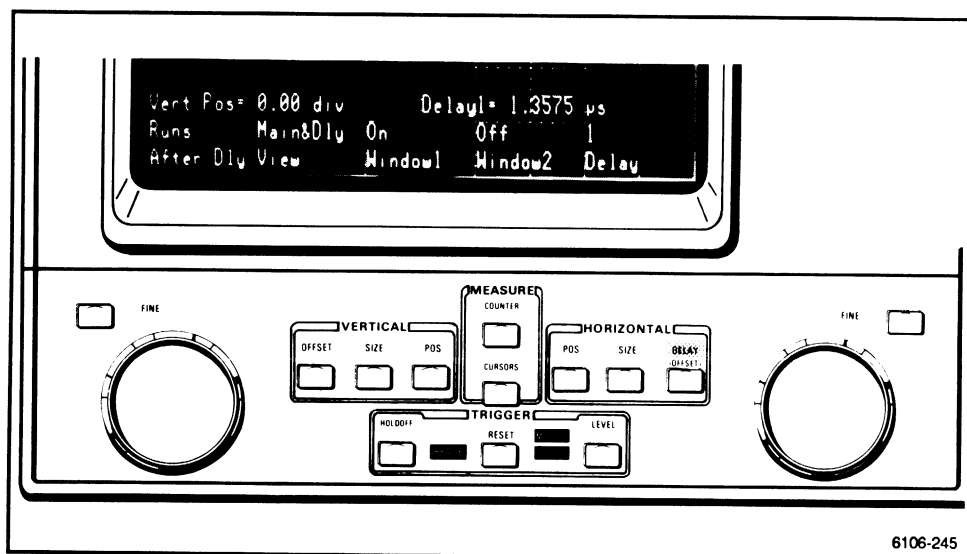

Figure 2-46. The DELAY control menu for YT traces.

Display Control

This section tells how to adjust the crt for astigmatism, trace contrast, character contrast, focus, and trace rotation. It also gives information on adjusting the intensity and graticule illumination.

Display Adjust Major Menu

The DISP ADJ major menu (as shown in Figure 2-47) presents the choices for various display adjustments. This major menu allows you to manually adjust focus, astigmatism, trace rotation, contrast between the Main sweep and its intensified zones, and contrast between the characters and the background shading. The status of the various selections is indicated by shading the choice within the menu.

When the DISP ADJ major menu button is pressed, Focus and Astigmatism are simultaneously assigned to the bottom control knobs. Focus is assigned to the left knob and Astigmatism to the right knob. The readout for the two knobs are labeled **Focus** and **Astigmatism**. Trace Rotation, when selected, is assigned to the right knob. The left knob is not assigned.

NOTE

This menu makes its own knob assignments and must be turned off before any control menu can assign the knobs.

To control the contrast between the intensified zone on the main traces, Δ Main can be used. Δ Char is used to control the difference of background shading to normal characters.

When Δ Main or Δ Char is selected, they are assigned to the right knob. The left knob is not assigned. When the menu is exited, the knobs return to the assignments prior to entering the DISP ADJ menu.

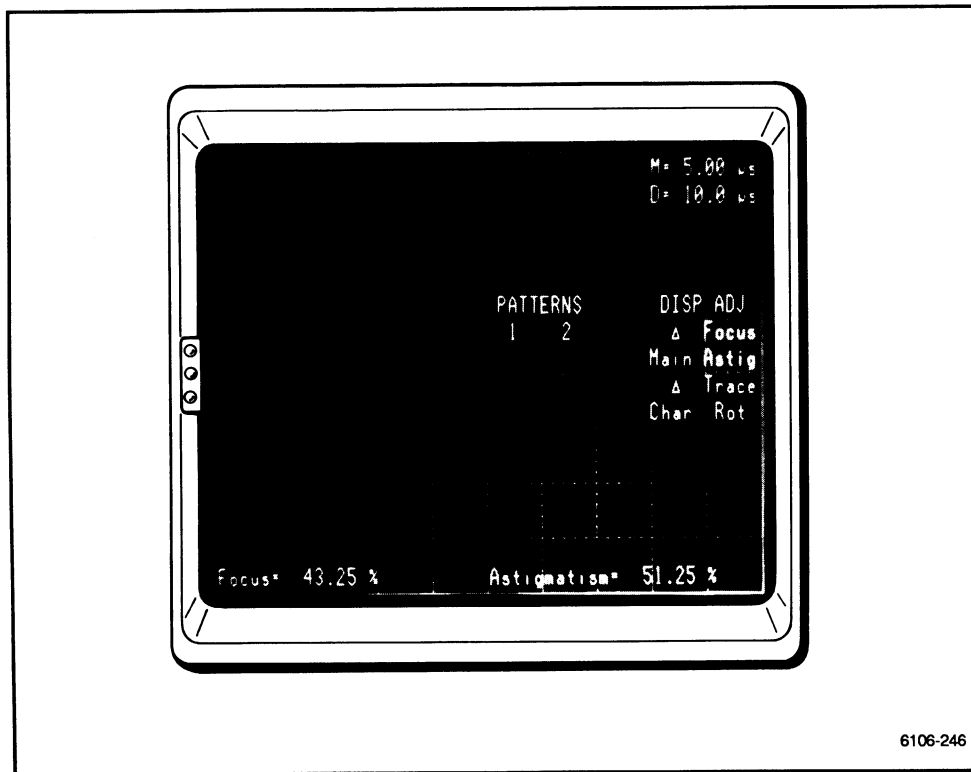

6106-246

Figure 2-47. The DISP ADJ (Display Adjust) major menu.

In addition to the selections for adjustments, two special display patterns can be displayed. These are intended primarily for service personnel. Once a pattern has been selected, all readout characters are removed, and then any major menu button can be pressed to remove a pattern and return to normal operation. Upon reentry, text is displayed once again.

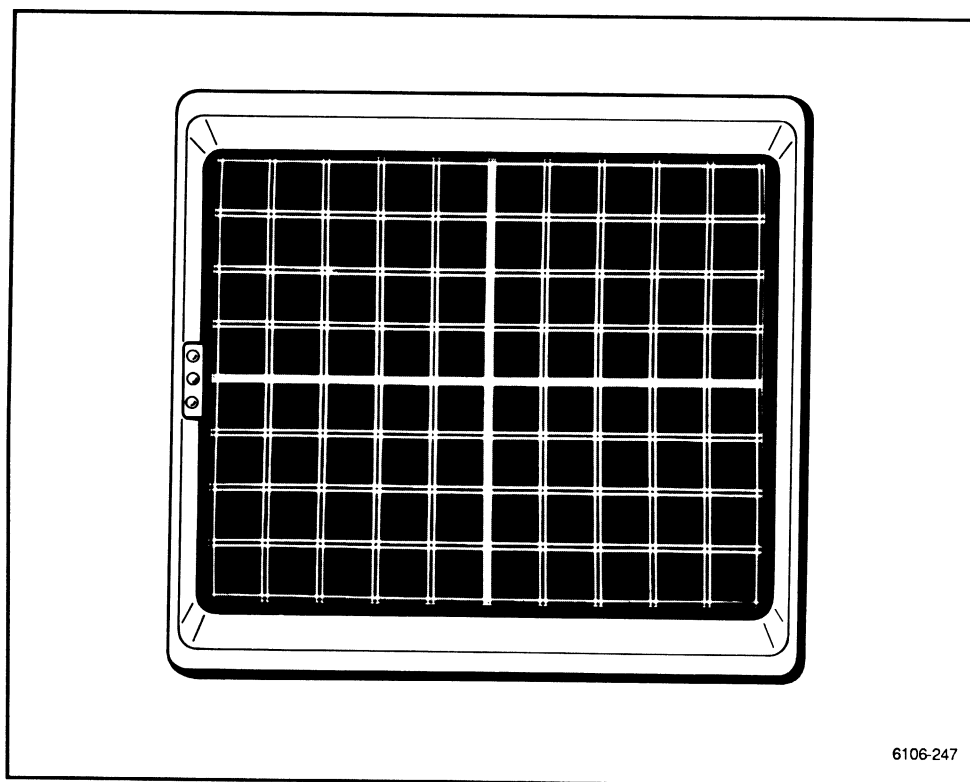

Figure 2-48. Crosshatch pattern 1 is useful for setting focus and astigmatism, and checking geometry and linearity.

Pattern 1 as shown in Figure 2-48 is used to set focus and astigmatism and check geometry and linearity. Geometry and linearity adjustments are accessible only to service personnel. This pattern is composed of dots spaced closely to form lines that fall on either side of the major graticule lines at a distance so as to have the graticule lines touch the display drawn lines if the geometry or linearity are not within specification. An additional vertical and horizontal line bisect the pattern and should fall on the center graticule lines if the display is properly aligned.

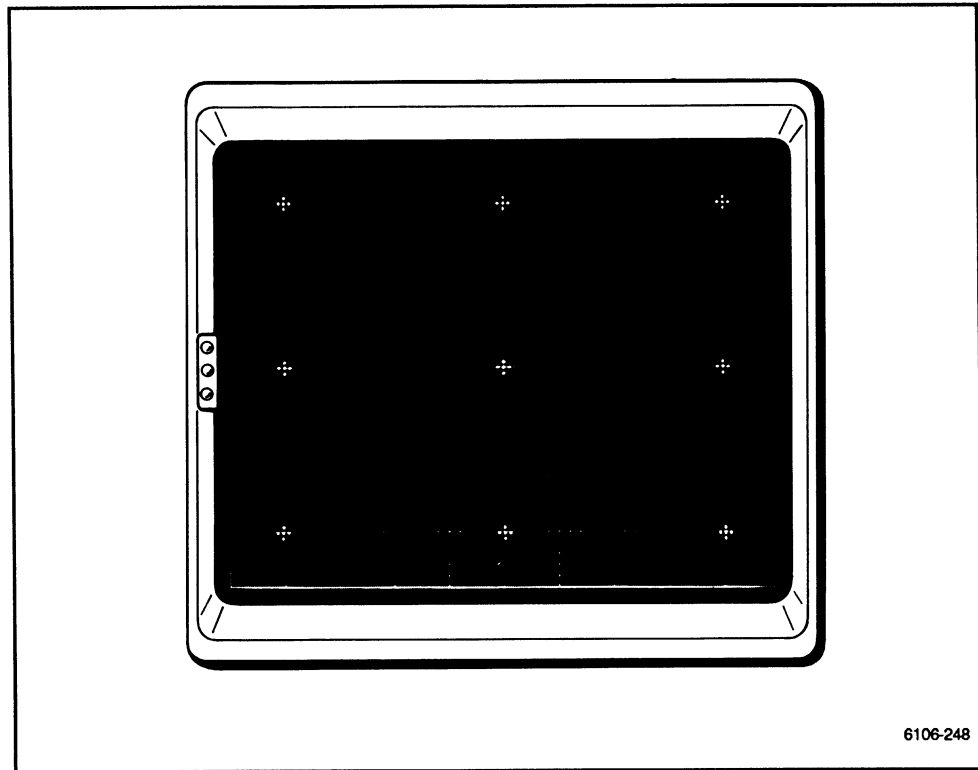

Figure 2-49. Pattern 2 is used during calibration to cancel "spot shift."

Pattern 2 (see Figure 2-49) is used in calibration to cancel the effect called "spot shift" present in the crt. "Spot Shift" is the small change in crt beam position as intensity varies. Each pattern has individually controllable intensity. These adjustments are for qualified service personnel only .

NOTE

Use of this pattern will result in Reference Waveforms 1 and 2 to be set to all zeros. Any data stored in Wfm1 and 2 will be lost upon display of pattern 2.

DISP ADJ Menu Knob Behavior

Whenever the knobs are assigned to a function found in the DISP ADJ menu, the LEDs on the front panel normally used for indicating knob function are turned off and the control menu is removed.

Whenever the knobs are assigned to Focus, Astigmatism, Trace Rotation, Δ Char Contrast, or Δ Main Contrast the control menu remains unchanged.

1. Focus and Astig
 - Fine increments are approximately 0.25% of full scale range.
 - Coarse increments are 2% of full scale range.
2. Δ Main and Δ Char Contrast
 - Coarse and Fine increments are 2% of full scale range.
3. Trace Rotation
 - Coarse and Fine increments are 0.5% of full scale.

Intensity

A single knob located above the crt controls the trace, character, and graticule intensities of the display. These five mutually exclusive assignments for the knob are:

- Character intensity
- Main Sweep intensity
- Delayed Sweep intensity
- XY intensity
- Graticule intensity

One of five LED indicators illuminates one choice in the list to show the present knob assignment. Pressing one of two buttons adjacent to the knob and LEDs selects the knob assignment. The buttons allow you to scan through the list in two directions (up and down). This selection will also "rollover." When the top of the column of choices is reached, pressing the "up arrow" button selects the item at the bottom of the column. Likewise, when the bottom of the column is reached, pressing the "down arrow" selects the item at the top of the column.

11302 Intensity Behavior

As a precaution in maintaining the micro-channel plate performance, a protection mechanism has been incorporated into the 11302. By monitoring the intensity of the display and the amount of user activity, the 11302 will determine if it is necessary to inhibit the display. This will protect the extremely sensitive crt and prolong its life.

There are two stages of inhibited display: complete shutdown and partial shutdown.

Complete Shutdown

If activity at the front panel, GPIB, or RS-232-C is not detected for a period of about five minutes, the entire display will be set to zero intensity. This includes all displayed characters and traces. This condition is indicated by blinking of the CHAR intensity LED. Pressing any button, turning a knob, or sending a command through the GPIB or RS-232-C will restore the display for viewing.

Partial Shutdown

Whenever the trace display intensity, trigger rate, and Time/div combine to exceed a pre-determined limit, a warning message appears to advise you to reduce the display intensity. If this condition persists for up to 30 seconds, the trace intensity will be set to zero. Any front panel, GPIB, or RS-232-C activity will reactivate the intensity. However, it is important for you to adjust the intensity level to avoid this condition.

INTENSITY Knob Behavior

Counterclockwise rotation decreases intensity; clockwise rotation increases intensity.

Valid settings for Character, Main Sweep, Delayed Sweep, XY, and Graticule intensities are linear increments of 0.5% of the full-scale range. The INTENSITY knob is always assigned to the last selected intensity.

When the character intensity is reduced to its minimum value, a software generated "click" indicates the characters are completely disabled. This allows waveforms to be displayed without holes caused by the momentary interruptions of writing the characters.

When the character intensity is disabled, one clockwise increment enables the characters and another "click" sounds.

NOTE

The term "characters" includes all display characters and graphics that are not analog real-time traces. This means the cursor lines, stored waveforms, and shading are controlled in this fashion.

The touch screen is completely disabled when the character intensity is off. However, the knobs and the knob assignment buttons will operate.

NOTE

Whenever the Time/div is changed, the oscilloscope attempts to adjust the intensity (+ or -) to maintain reasonable brightness.

Measurement

This section discusses the Counter/Timer, the Cursors, and the MEASURE major menu.

Counter/Timer

The Counter/Timer is treated as an integral part of the user interface of the instrument rather than a completely independent entity. This means that no one menu gives you the Counter/Timer functions, but that they are accessed through several menus: Trigger, Counter, Numeric Entry, and Waveform. See the simplified block diagram of the Counter/Timer in "Counter/Timer Concepts" in this subsection.

Counter/Timer Controls and Functions

The Counter/Timer has several parameters that specify its behavior and performance. While making a measurement, you may freely adjust these parameters. In most cases, changing a parameter will restart the measurement.

Averaging

Averaging selects the desired number of averages that determine the measurement resolution when measuring Frequency, Period, Width, Ratio, or Time. The choices for averaging are 1, $\approx 10^2$, $\approx 10^4$, $\approx 10^6$, $\approx 10^8$, $\approx 10^{10}$, and **Auto**. Auto updates the measurement every 0.3 second or until one average is completed, whichever is greater. "Single-shot" measurements are made and displayed when Averages=1 (no averaging).

Count Ref

Count Reference (a NUMERIC ENTRY major menu feature) displays a number that is subtracted from all measurements. For example, a frequency result of 10 kHz can be established as the reference for all subsequent measurements. When set, the reading for frequency becomes the difference of the new value minus the reference yielding a delta frequency. The reference value is displayed on the same line as the measured values. The Count Reference feature is not available for **Total**. To use the present measurement result as the reference value, touch **Null** in the NUMERIC ENTRY menu.

Counter Source Selection

Source choices are the Main and Delayed internal triggers and the A External input for measuring **Frequency**, **Period**, and **Width**. The Main and Delayed sweep gates and trigger or the CT A and CT B External inputs are sources for **Time A→B**. For **Total** and **Ratio**, the choices are the CT A and B External triggers and the Main and Delayed Internal inputs. Also, Main trigger and CT B External may be used for **Ratio**.

Restrictions and Interactions

- If there is a conflict between the use of the CT External inputs as a measurement source or gating source, one of two messages appear.
 1. If source is already external and external gating is selected, the source is forced to M&D1 Trig and this message appears:

"Source is M&D1 Trig—Ext A&B can be Gate OR Source"
 2. If already in external gate and external source is selected, then gating is forced to off and this message appears:

"Gating is Off—Ext A&B can be Gate OR Source"
- If *Source* is selected to be **A&B Ext** when making **Total** or **Ratio** measurements or **A Ext** when making **Freq**, **Period**, or **Width** measurements, then gating cannot be **Ext A→B** or **B Ext**. If gating was set to one of these, then gating should be set to **Off**.
- If the source for **Total** or **Ratio** is already **A&B Ext** or **Freq**, **Period**, or **Width** is already **A Ext**, and the gating is selected to be **Ext A→B** or **B Ext**, then the source should be changed to **M&D1 Trig**.
- If Dly1 trigger is used as the measurement source and Window 2 is selected, this message is displayed:

"For accurate results remove Dly2 Window"

A similar conflicting situation occurs when Dly2 trigger is used as the measurement source and Window 1 is displayed. This message is displayed:

"For accurate results remove Dly1 Window"
- If while using Main or Delayed trigger as the measurement sources and the Time/div or Delay change, the Counter/Timer is reset and restarted.
- If the source is **Dly2**, gating by **Dly1 Swp** is not allowed and this message is displayed:

"Source is Main Trig – Cannot Gate Dly2 by Dly1"
- If the source is **Dly2** and *Window2* is **Off**, the measurement will use Dly1 Trigger as the source but indicate Dly2 in the menu.

Gating

Gating allows you to exclude the counting of events or features of a signal, and to have more control over the measurement. As an aid in measurement gating, counter view traces may be displayed along with the plug-in analog waveforms. (See "Counter View Traces" in this subsection for more information.) These are the choices allowed with gating:

Dly1 Swp—(Window 1 Delayed Sweep Gate) which is the approximate location of the Dly1 intensified zone on the main sweep trace.

B External input.

Ext A→B—Arm on A (start gate) and Disarm on B (stop gate) inputs, which are one of many uses for the EXTERNAL A and B INPUTS located on the lower-right, front corner of the instrument. The slope and level of the A and B inputs may be modified with the LEVEL control menu.

Off—means there is no gating, and the measurement is over a continuous interval.

Measure

Measurements has unique values for Averages, Gating, and Reference settings (e.g., Ratio can be set for a different number of averages than Frequency without interfering with it). A discussion follows of each of the *Measure* choices of **Frequency**, **Off**, **Period**, **Ratio**, **Time A→B**, **Total**, and **Width**.

Frequency

Table 2-18 shows the number of significant digits for Frequency, f , with averaging N times. The maximum number of significant digits equal 7 when the oven stabilized internal reference is not used. $f=1/\text{period}$ is then rounded to the number of digits given in the table. (Also see and Fig. 2-50 and Table 2-19.)

The number of significant digits displayed for Frequency **Auto** Averages will be dependent on the number of averages in the measurement interval (≥ 300 ms). Table 2-18 may be used to determine the number of digits displayed where N equals the number of periods in the Auto measurement interval.

The number of digits shown are limited to ensure that the actual frequency is within one count of the indicated frequency (assuming no time base or trigger jitter error).

TABLE 2-18
Significant Digits for Frequency (N = Number of Averages)

(f in Hz)	N=1	N=10 ²	N=10 ⁴	N=10 ⁶	N=10 ⁸	N=10 ¹⁰
f < 1 mHz	10	10	10	10	10	10
1 mHz ≤ f < 2.36 mHz	10	10	10	10	10	10
2.36 mHz ≤ f < 7.45 mHz	10	10	10	10	10	10
7.45 mHz ≤ f < 10 mHz	10	10	10	10	10	10
10 mHz ≤ f < 23.6 mHz	10	10	10	10	10	10
23.6 mHz ≤ f < 74.5 mHz	10	10	10	10	10	10
74.5 mHz ≤ f < 100 mHz	9	10	10	10	10	10
100 mHz ≤ f < 236 mHz	10	10	10	10	10	10
236 mHz ≤ f < 745 mHz	9	10	10	10	10	10
745 mHz ≤ f < 1 Hz	8	10	10	10	10	10
1 Hz ≤ f < 2.36 Hz	9	10	10	10	10	10
2.36 Hz ≤ f < 7.45 Hz	8	10	10	10	10	10
7.45 Hz ≤ f < 10 Hz	7	9	10	10	10	10
10 Hz ≤ f < 23.6 Hz	8	10	10	10	10	10
23.6 Hz ≤ f < 74.5 Hz	7	9	10	10	10	10
74.5 Hz ≤ f < 100 Hz	6	8	10	10	10	10
100 Hz ≤ f < 236 Hz	7	9	10	10	10	10
236 Hz ≤ f < 745 Hz	6	8	10	10	10	10
745 Hz ≤ f < 1 kHz	5	7	9	10	10	10
1 k Hz ≤ f < 2.36 kHz	6	8	10	10	10	10
2.36 kHz ≤ f < 7.45 kHz	5	7	9	10	10	10
7.45 kHz ≤ f < 10 kHz	4	6	8	10	10	10
10 k Hz ≤ f < 23.6 kHz	5	7	9	10	10	10
23.6 kHz ≤ f < 74.5 kHz	4	6	8	10	10	10
74.5 kHz ≤ f < 100 kHz	3	5	7	9	10	10
100 kHz ≤ f < 236 kHz	4	6	8	10	10	10
236 kHz ≤ f < 745 kHz	3	5	7	9	10	10
745 kHz ≤ f < 1 MHz	2	4	6	8	10	10
1 MHz ≤ f < 2.36 MHz	3	5	7	9	10	10
2.36 MHz ≤ f < 7.45 MHz	2	4	6	8	10	10
7.45 MHz ≤ f < 10 MHz	1	3	5	7	9	10
10 MHz ≤ f < 23.6 MHz	2	4	6	8	10	10
23.6 MHz ≤ f < 74.5 MHz	1	3	5	7	9	10
74.5 MHz ≤ f < 100 MHz	1	2	4	6	8	10
100 MHz ≤ f < 236 MHz	1	3	5	7	9	10
236 MHz ≤ f < 745 MHz	1	2	4	6	8	10
745 MHz ≤ f	1	1	3	5	7	9

NOTE

Although results can be presented for the frequencies above 500 MHz, their accuracy is not specified.

For the table above, f represents the internal representation for Frequency. The number of significant digits are determined using f, and then the Frequency value is formatted for display and finally rounded for display purposes. Therefore, it is possible to view a displayed result of 1.000 MHz (N=10²) shown with 4 digits even though the tables suggest 5 digits. The fact is that the Frequency is actually slightly less than 1.000 MHz. For example, the Measured frequency is 999.9998 kHz. When displayed with 4 digits of precision, it appears rounded to 1.000 MHz.

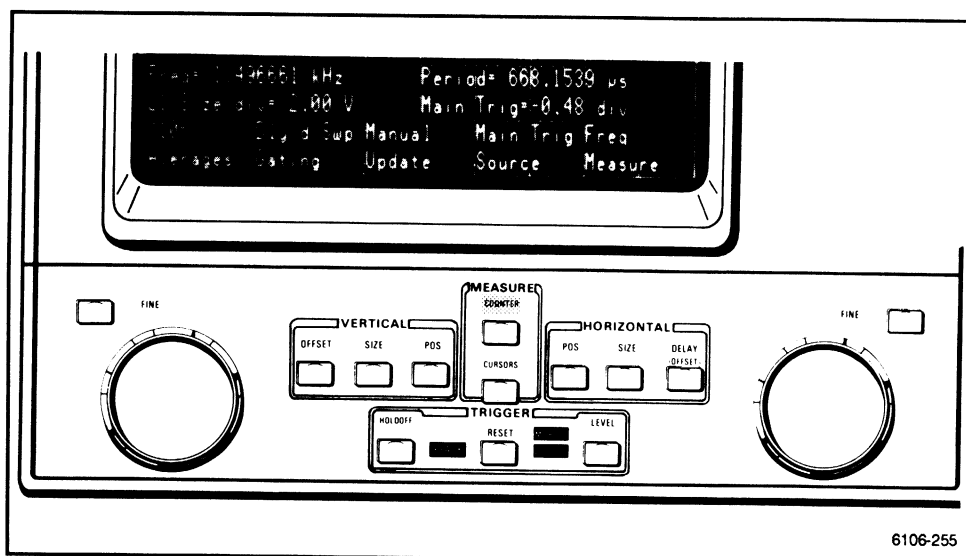

Figure 2-50. The COUNTER control menu showing the measured results for Frequency.

TABLE 2-19
Menu Choices for Frequency Measurements

Averages	Gating	Update	Source	Measure
1	Dly1 Swp	Manual	Main Trig	Freq
$\approx 10^2$	B Ext	Auto	Dly1 Trig	
$\approx 10^4$	Ext A→B		Dly2 Trig	
$\approx 10^6$	Off		A Ext	
$\approx 10^8$				
$\approx 10^{10}$				
Auto				

Repeatedly touching a menu function on the screen cycles through all possible choices.

Off

Off erases the counter results from the display and shuts off the Counter/Timer to keep warning messages from interfering with other operations. Notice in Table 2-20 the absence of menu choices when **Off** is selected.

Period

Table 2-20 shows the number of significant digits for Period averaging N times. The maximum number of significant digits equals seven when the oven-stabilized internal reference is not used. Figure 2-51 shows an example of the MEASURE menu when **Period** has been selected and Table 2-21 shows the function choices available.

The number of significant digits displayed for Period **Auto** Averages will be dependent on the number of averages in the measurement interval (≥ 300 ms). Table 2-20 may be used to determine the number of digits displayed where N equals the number of periods in the Auto measurement interval.

TABLE 2-20
Significant Digits for Period (N = Number of Averages)

(t in Sec)	N=1	N=10 ²	N=10 ⁴	N=10 ⁶	N=10 ⁸	N=10 ¹⁰
1 s ≤ t	10	10	10	10	10	10
1 s > t ≥ 100 ms	9	10	10	10	10	10
100 ms > t ≥ 10 ms	8	10	10	10	10	10
10 ms > t ≥ 1 ms	7	9	10	10	10	10
1 ms > t ≥ 100 μs	6	8	10	10	10	10
100 μs > t ≥ 10 μs	5	7	9	10	10	10
10 μs > t ≥ 1 μs	4	6	8	10	10	10
1 μs > t ≥ 100 ns	3	5	7	9	10	10
100 ns > t ≥ 10 ns	2	4	6	8	10	10
10 ns > t ≥ 1 ns	1	3	5	7	9	10
1 ns > t	*	*	*	*	*	*

* indicates where the Counter/Timer results will be displayed as zeros.

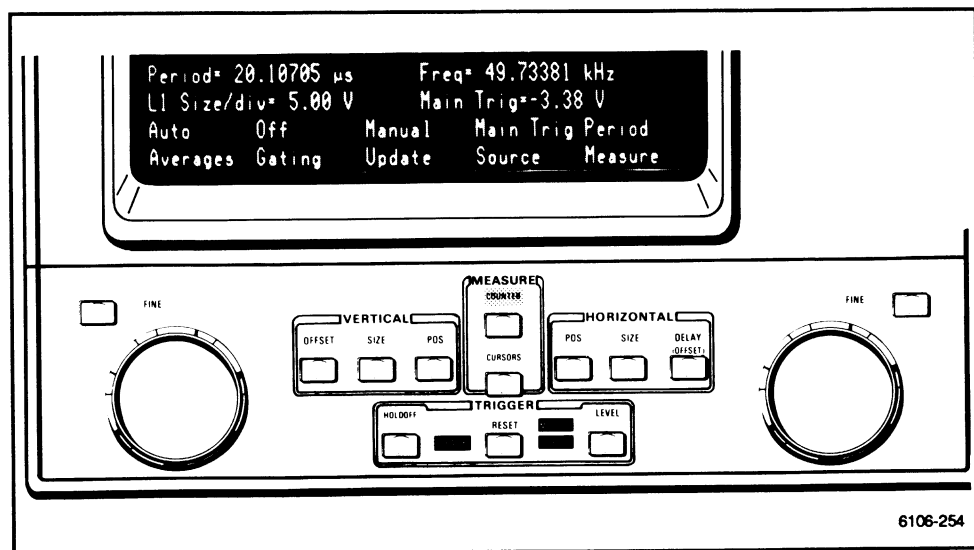

Figure 2-51. The Counter control menu showing the measured results for Period.

TABLE 2-21
Menu Choices for Period Measurements

Averages	Gating	Update	Source	Measure
1	Dly1 Swp	Manual	Main Trig	Period
$\approx 10^2$	B Ext	Auto	Dly1 Trig	
$\approx 10^4$	Ext A→B		Dly2 Trig	
$\approx 10^6$	Off		A Ext	
$\approx 10^8$				
$\approx 10^{10}$				
Auto				

Repeatedly touching a menu function on the screen cycles through all possible choices.

Ratio

In **Ratio** the counter measures the number of events on both channels for Main and Delay internal triggering, A & B External inputs, or Main and B External inputs during the time it takes to accumulate the selected number of Main or A External events (averaged by Main or A External events). See Table 2-22 and Figure 2-52 for menu choices when using Ratio. The total number of Delayed or B External events is then divided by the total number of Main or A External events, and the answer is displayed without units.

The ratio range is from 10^{-11} to 10^{11} . Applying the higher frequency to Delay or B External produces a ratio greater than one; applying the lower frequency to Delay or B External produces a ratio less than one. For better resolution with Averaging other than Auto, apply the higher frequency signal to Delay trigger or B External; Averaging will then be based on the lower frequency which will result in a longer measurement interval and more resolution.

TABLE 2-22
Menu Choices for Ratio Measurements

Averages	Gating	Update	Source	Measure
1	Dly1 Swp	Manual	M&D1 Trig	Ratio
$\approx 10^2$	B Ext	Auto	M&B Ext	
$\approx 10^4$	Ext A→B		A&B Ext	
$\approx 10^6$	Off			
$\approx 10^8$				
$\approx 10^{10}$				
Auto				

Repeatedly touching a menu function on the screen cycles through all possible choices.

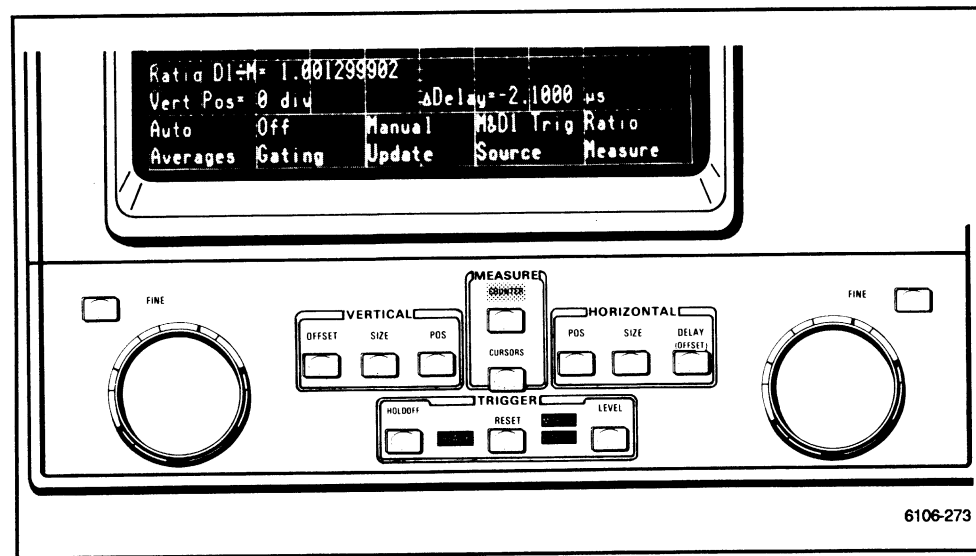

Figure 2-52. The COUNTER menu choices when using Ratio.

Time A→B

If the measurement source is set to **Swp Start** and only one window is displayed, the time between the main and the delayed sweep gate is displayed. If both delayed windows are displayed, then the time difference between the two windows is displayed as Time D1→D2. This is actually measured as the difference between the Main to Dly1 sweep start subtracted from the Main to Dly2 sweep start. If no delayed zones exist this message will prompt you that one is required:

"Delayed Window required for Time A→B."

A & B External Source

For the measurement type Time A→B with CT External A & B as the inputs, the time interval measured occurs between the edges of the A & B External inputs. This mode is equivalent to the Time A→B mode of conventional counter/timers and allows the user to free the trigger inputs of the oscilloscope for other uses. With a positive slope selected for both A & B External triggers, the time interval measured starts on the positive transition of A and ends on the positive transition of B. The slope selection allows you to invert the transition direction that begins and ends the time interval. The level can be set independently for the A & B External trigger. The **A Ext** and **B Ext** traces in the Counter View waveform menu may be used as an aid in setting the slope and level of these inputs. Using these inputs allows measurements to be independent of plug-in traces and other trigger sources. A minimum time interval of 2 ns is required.

Main and Delayed Trigger Source

For the measurement type Time A→B with Main and Delayed triggers as the inputs, the time interval measured occurs between the edges of the Main and Delayed trigger inputs. This mode offers the advantage of using the different capabilities of the plug-in amplifiers such as amplifier conditioning, increasing sensitivity, and displaying analog signals. With positive slope selected for both Main and Delayed triggers, the time interval measured starts on the positive transition of the Main trigger and ends on the positive transition of the Delayed trigger. The slope selection allows you to invert the transition direction that begins and ends the time interval. The level setting for these measurements from the Main and Delayed trigger source use the same slope and level settings as used in triggering the sweeps. A minimum time interval of 2 ns is required when using these inputs.

Table 2-23 shows the number of significant digits for Time A→B or Width averaging N times. The maximum number of significant digits equals 7 when the oven stabilized internal reference is not used. See Fig 2-54 and Table 2-25 for control menu choices.

The number of significant digits displayed for Time A→B **Auto** Averages will be dependent on the number of averages in the measurement interval (≥ 300 ms). See Table 2-23.

TABLE 2-23
Significant Digits for Time A→B (M→D Trig, CT Ext A & B)
and Width (N = Number of Averages)

(t in Sec)	N=1	N=10 ²	N=10 ⁴	N=10 ⁶	N=10 ⁸	N=10 ¹⁰
1 s	10	10	10	10	10	10
1 s > t ≥ 100 ms	9	9	10	10	10	10
100 ms > t ≥ 10 ms	8	8	9	10	10	10
10 ms > t ≥ 1 ms	7	7	8	9	10	10
1 ms > t ≥ 100 μs	6	6	7	8	9	10
100 μs > t ≥ 10 μs	5	5	6	7	8	9
10 μs > t ≥ 1 μs	4	4	5	6	7	8
1 μs > t ≥ 100 ns	3	3	4	5	6	7
100 ns > t ≥ 10 ns	2	2	3	4	5	6
10 ns > t ≥ 1 ns	1	1	2	3	4	5

Table 2-24 shows the number of significant digits for Time A→B averaging N times. The maximum number of significant digits equals 7 when the oven stabilized internal reference is not used. See Fig 2-54 and Table 2-25 for control menu choices.

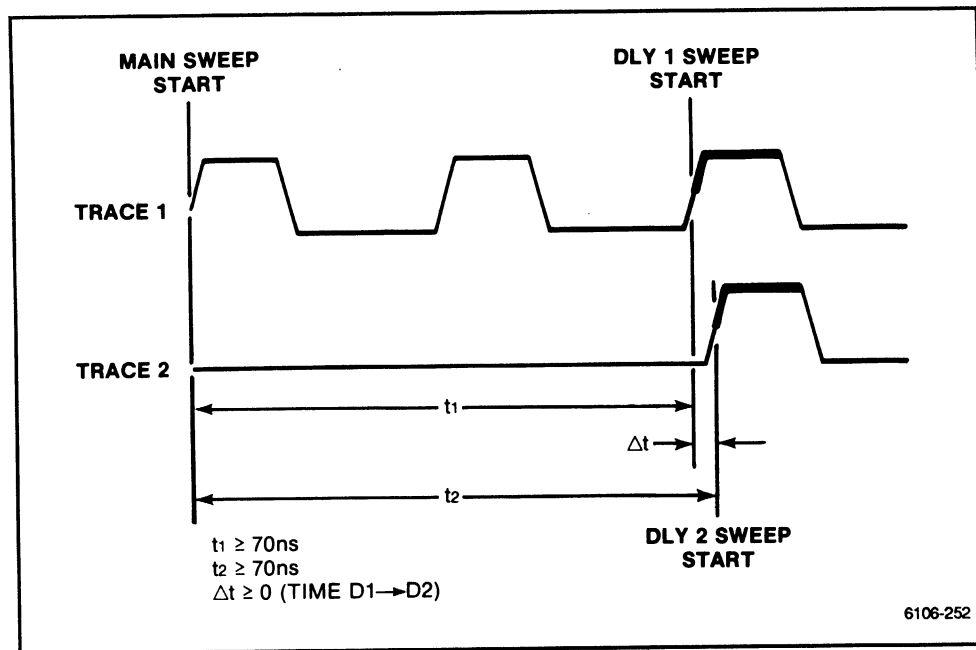

Figure 2-53. Precision timing between any two events is provided when using both window 1 and 2. The difference between Dly1 and Dly2 can equal zero.

Swp Start

Selecting **Swp Start** as the measurement source allows complex time interval measurements to be made with the aid of the Delayed sweep. Measurements begin at the start of the Main sweep and end at the start of the Delayed sweep. The versatility of this measurement comes about by the ability of the Main sweep to be synchronized to complex signals using Holdoff and the capability of the delayed sweep to be run after delay (for easy measurement setup) or triggered after delay for more precise measurement. The adjustable slope and level of the Delayed trigger allows the end of the measurement interval point on a waveform to be independently set with respect to the starting point.

The ability to define two windows on the Main sweep adds even more capability. The Counter/Timer will automatically subtract the time measured between the start of the Main sweep and Window 1 from the time measured between the start of the Main sweep and the start of Window 2. (There are limitations. When **Swp Start** is selected as the measurement source, the minimum time interval from Main to Dly1 or Dly2 sweep starts is 70 ns. However, the difference between Dly1 and Dly1 may be zero. See Figure 2-53.) Each window may have its delay time, source, level, and slope set independently for complete flexibility in setting the measurement interval. The intensified zones begin at approximately the same time as the Delayed sweep begins. By this means, the intensified zones can be used as markers to locate waveform features while the Counter/Timer measures the time between them. At faster Main sweep speeds, where the intensified zone is not as well defined, the Counter View may be used to aid in the selection of the measurement interval.

The number of significant digits displayed for Time A→B **Auto** Averages will be dependent on the number of averages in the measurement interval (≥ 300 ms). See Table 2-24.

TABLE 2-24
Significant Digits for Time A→B (Time D2→D1 and M→D1 Sweeps)
(N = Number of Averages)

(t in Sec) ¹	N=1	N=10 ²	N=10 ⁴	N=10 ⁶	N=10 ⁸	N=10 ¹⁰
1 s ≤ t	10	10	10	10	10	10
1 s > t ≥ 100 ms	9	9	10	10	10	10
100 ms > t ≥ 10 ms	8	8	9	10	10	10
10 ms > t ≥ 1 ms	7	7	8	9	10	10
1 ms > t ≥ 100 μs	6	6	7	8	9	10
100 μs > t ≥ 10 μs	5	5	6	7	8	9
10 μs > t ≥ 1 μs	4	4	5	6	7	8
1 μs > t ≥ 100 ns	3	3	4	5	6	7
100 ns > t ≥ 10 ns	2	2	3	4	5	6
10 ns > t ≥ 1 ns	1	1	2	3	4	5
1 ns > t ≥ 100 ps	*	*	1	2	3	4
100 ps > t ≥ 10 ps	*	*	*	1	2	3
10 ps > t ≥ 1 ps	*	*	*	*	1	2
1 ps > t ≥ 100 fs	*	*	*	*	*	1
100 fs > t	*	*	*	*	*	*

NOTE

Measurement results of less than 1 ns in this table apply only to measuring between two Delayed Windows (Time D1→D2).

** indicates where the Counter/Timer results will be displayed as zeros.*

¹For Time D2→D1, t represents the magnitude of the results.

TABLE 2-25
Menu Choices for Time A→B Measurements

Averages	Update	Source	Measure
1	Manual	Swp Start	Time A→B
≈10 ²	Auto	A&B Ext	
≈10 ⁴		M&D1 Trig	
≈10 ⁶			
≈10 ⁸			
≈10 ¹⁰			
Auto			

Repeatedly touching a menu function on the screen cycles through all possible choices.

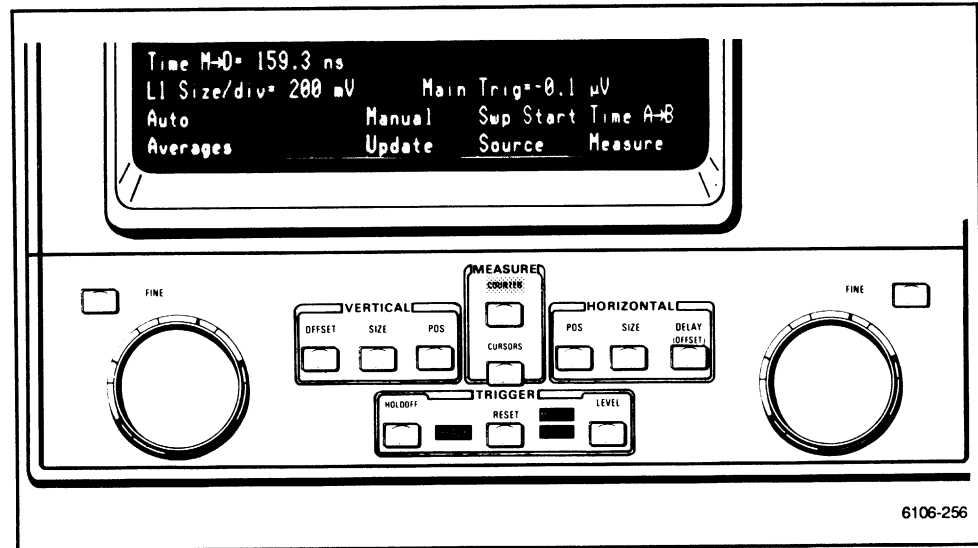

Figure 2-54. The COUNTER menu showing the difference between the Main and Dly1 sweep gates as Time M→D.

Total

Total is two sources measured simultaneously. (See Table 2-26 and Figure 2-55 for menu choices when using Total.) If the measurement is gated, then the totals are the counts within the gated interval. A Ext and M Trig sources display the total count and the time elapsed during which the total is accumulating. Ext A→B gating of Total is not available when the A Ext input is selected as the source. Selection of an invalid source/gating combination will default to valid settings. If Total has been stopped by other than the Update function (e.g., by pressing Enhanced Accuracy, Measure, or Autoset), the following message appears. "Counter/Timer TOTAL measurement has been stopped."

TABLE 2-26
Menu Choices for Total Measurements

Gating	Update	Source	Measure
Dly1 Swp B Ext Ext A→B Off	Running Stopped	M&D1 Trig A&B Ext A Ext M Trig	Total

Repeatedly touching a menu function on the screen cycles through all possible choices.

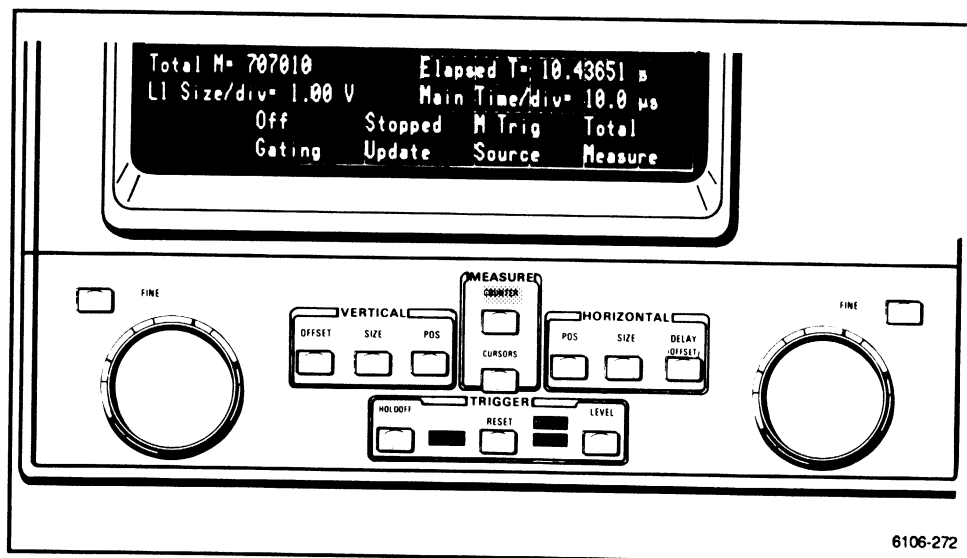

Figure 2-55. The COUNTER menu for Total.

Width

Width is the measured time between two adjacent transitions having opposite polarity. The width measurement begins on a transition that has its polarity set by the slope setting (+ equals a positive edge; - equals a negative edge) for the measurement source selected. See Table 2-27 and Figure 2-56 for menu choices when using Width.

TABLE 2-27
Menu Choices for Width Measurements

Averages	Gating	Update	Source	Measure
1	Dly1 Swp	Manual	Main Trig	Width
≈10 ²	B Ext	Auto	Dly1 Trig	
≈10 ⁴	Ext A→B		Dly2 Trig	
≈10 ⁶	Off		A Ext	
≈10 ⁸				
≈10 ¹⁰				
Auto				

Repeatedly touching a menu function on the screen cycles through all possible choices.

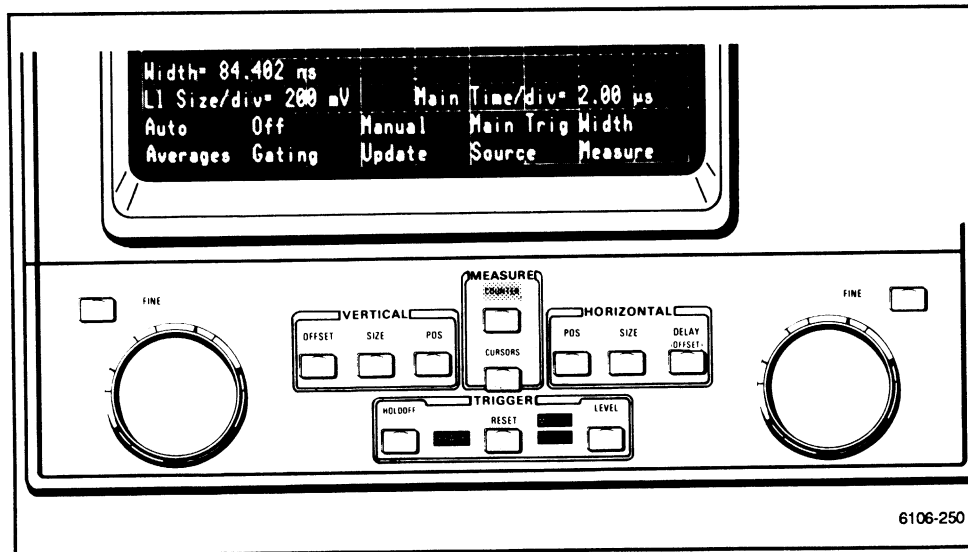

Figure 2-56. The COUNTER menu for Width.

Updating

Updating allows you to observe changes in the measurement result by constantly refreshing or, when completed, holding the results. For **Total**, the choices are **Running** and **Stopped**; for all other measurements, the choices are **Manual** or **Auto**. **Auto** updates the results every 300 ms or after the measurement average is complete. **Manual Update** will hold the current results until a new measurement is started by pressing RESET, choosing **Auto Update**, or initiating a GPIB measurement.

Because the results of the Counter/Timer use the prompting area in the display, there are times when the two conflict. Prompts, warning, and error messages have the same priority as a result. Therefore, a new message can replace an old result, and a new result can replace an old message.

When a message is cleared and the counter result hasn't been updated, it will be restored to the last legal state (e.g., Freq=xxxx will reappear and not wait for a new result). Touching the screen restores the measurement results, providing the message has been dealt with.

If no signal has been detected after a period of 3 seconds for internal measurement sources or 5 seconds for external measurement sources, this message is displayed:

"COUNTER: Waiting to Start Measurement"

For measurements, in **Auto** or **1**, that take longer than 3 seconds for Main or Delayed internal sources or 5 seconds for external A and/or B sources and the number of averages reached is greater than 1, this message is displayed:

"COUNTER: Waiting to finish Measurement"

For measurements, in **Averages** equal to $\approx 10^2$, $\approx 10^4$, $\approx 10^6$, $\approx 10^8$, or $\approx 10^{10}$, that take longer than 3 seconds for Main and Delayed sources or 5 seconds for external sources and the number of averages reached (n) is greater than 1, this message is displayed:

"COUNTER: Still Measuring. Averages = n"

Any of the messages which overwrite the displayed results of the measurement may be removed by simply touching any area of the screen. Previously acquired results will be recalled and displayed until another timeout period elapses.

Counter/Timer Knob Assignments

The counter button is the exception to the operating conventions of the knob assignment buttons. Although the counter has its own menu, it does not have any unique knob functions. As the Counter/Timer is affected by virtually every control and mode of the oscilloscope (e.g., Trigger Level, Trigger Sensitivity, Vertical Size, Delayed Time/div, etc.), it is necessary to permit the use of all oscilloscope controls while viewing the the result of the counter.

To do this, the result of the Counter/Timer is displayed in the prompting line directly above the knob setting line in the display. In this way, adjustments can be made while observing their influence on the results.

Immediately after you press the COUNTER button, and before either control knob is moved, its menu is displayed while maintaining the previous knob assignments. Figure 2-57 shows the left knob controlling L1 Size/div and the right knob controlling the Main Trigger Level.

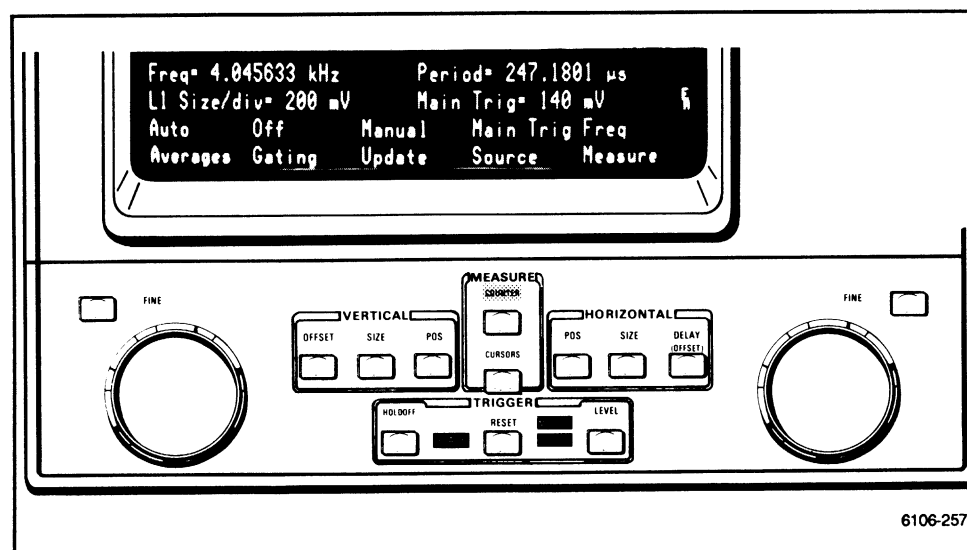

Figure 2-57. The COUNTER menu before either knob is moved (previous knob assignments displayed).

Fig. 2-58 shows that alternate presses of the COUNTER button (as with all menu buttons) remove its menu and preserve the knob setting and displayed results.

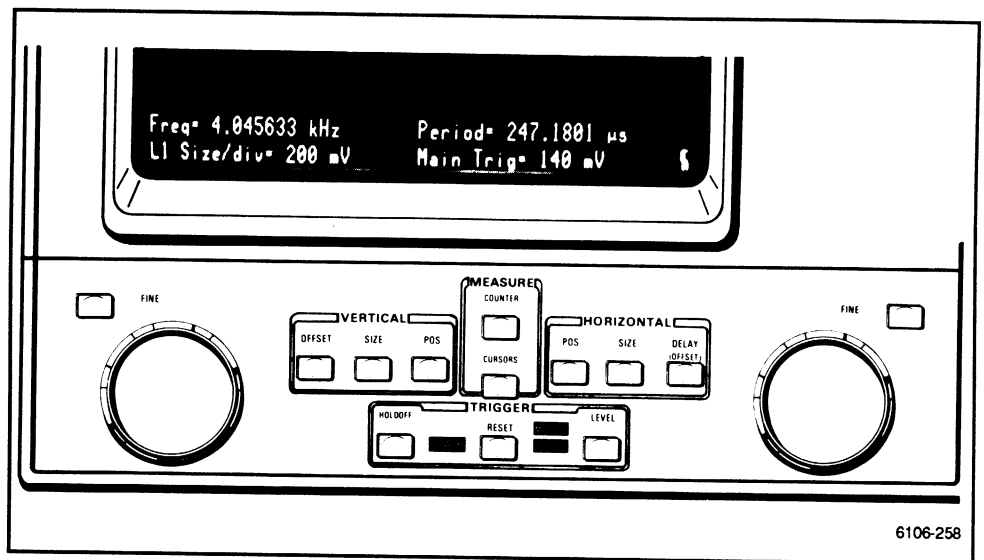

Figure 2-58. Alternate presses of the COUNTER button preserve the knob setting and results.

So long as the Measure setting of the counter is not **Off**, the results and labels of the Counter/Timer remain displayed even when another knob assignment is made. In Figure 2-59, the TRIGGER LEVEL button has been pressed, calling up its own menu while the results of the Counter/Timer are still displayed. The results and labels (e.g., Freq=) of the Counter/Timer can be removed from the display by setting *Measure* to **Off**.

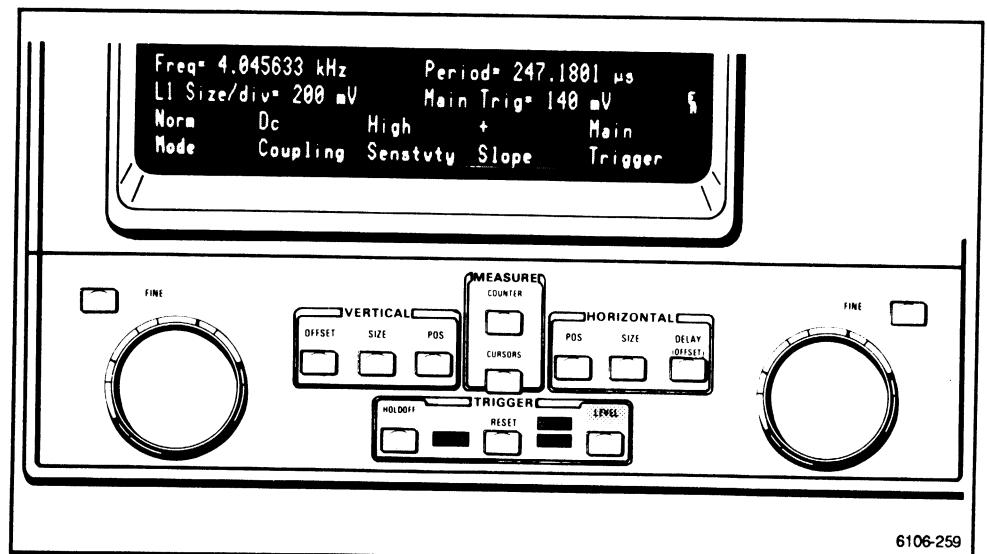

Figure 2-59. Here the TRIGGER LEVEL button has been pressed, calling up its own menu while the results of the Counter/Timer are still displayed.

Counter/Timer Operation

The Counter/Timer can operate even though its menu is not displayed. This allows you to manipulate other oscilloscope features that require the same menu space without disturbing a measurement in progress.

This is not to say you can't disturb it by some action. Whenever Enhanced Accuracy, Measure, or Autoset is executing, the measurement of the Counter/Timer is aborted. The measurement (except for **Total**) resumes when Enhanced Accuracy, Measure, or Autoset completes. When **Total** is interrupted, it does not resume, but clears and displays a message alerting you that the result has been disturbed.

Selections of *Gating*, *Averaging*, *Updating*, and *Source* are accessed through the COUNTER button, located between the two knobs and above the CURSOR button.

The currently measured signal source(s) is (are) derived from the time-base trigger or the EXTERNAL A and B INPUTS. This requires you to use the TRIGGER SOURCE major menu to specify the signals to be measured if the time-base triggers are used.

The Counter/Timer results can be viewed in a continuously updated fashion or held after one measurement is completed. If **Auto Update** is chosen, the display of the measured results updates each time a new result is computed or as soon as the display allows, whichever is slower. The fastest Auto update rate is limited to about 0.3 seconds.

If the result is held after the completion of a measurement (**Manual Update**), the result remains displayed until the RESET button is pressed, the rear panel RESET signal input transitions to a "high" state, or another measurement is selected. While **Totaling**, the update choices are **Running** and **Stopped**. When started after a stop, **Total** continues from its old value.

To freeze a result that would otherwise change too rapidly, selecting **Manual Update** (or **Stopped Update** when **Totaling**) holds the last measurement result indefinitely. Changing the update setting to **Manual** or **Stopped** never clears or removes results from the display. Touching *Update* again will resume updating.

To completely remove the Counter/Timer results and labels from the display, set *Measure* to **Off**.

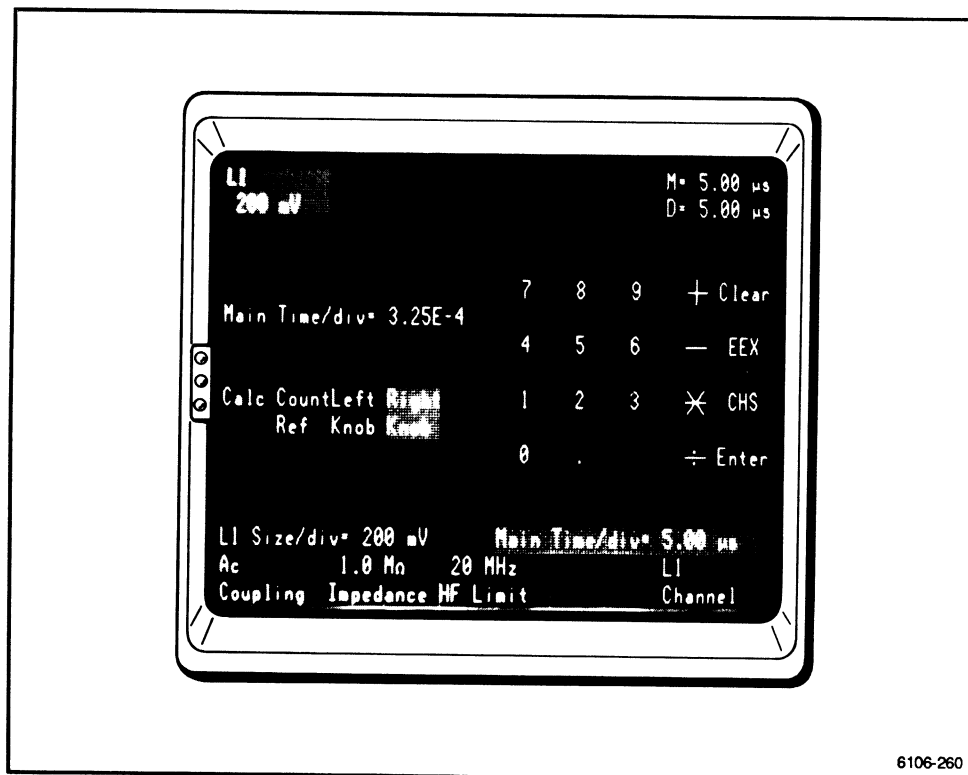

6106-260

Figure 2-60. The NUMERIC ENTRY menu with a relative reference value set.

In addition to viewing the measured results, a reference value for relative comparisons can be set by using the NUMERIC ENTRY major menu. (See Fig. 2-60.) With the reference value set to zero, the actual measured result is displayed. Table 2-28 shows the format for zero reference values when the NUMERIC ENTRY menu is **Off**.

TABLE 2-28
Format for Zero Reference and NUMERIC ENTRY Off

Selected Measurement	Left Half	Display Right Half
Time A→B (if D1 & D2 sweeps are in use and source=Swp Start)	Time D1→D2=<measured>	
(if only one delayed sweep is in use or Ext A→B is selected)	Time M→D=<measured>	
(if Source=M&D Trigs)	Time M→D1=<measured>	
Frequency	Freq=<measured>	Period=<1/Freq>
Period	Period=<measured>	Freq=<1/Period>
Total (if selected source = A&B Ext)	Total A=<measured>	Total B=<measured>
Total (if selected source = A Ext)	Total A=<measured>	Elapsed=<measured>
Total (if selected source = M&D1)	Total M=<measured>	Total D1=<measured>
Total (if selected source = M Trig)	Total M=<measured>	Elapsed=<measured>
Ratio (if selected source = A&B Ext)	Ratio B+A=<measured>	
Ratio (if selected source = M&D1)	Ratio D1+M=<measured>	
Ratio (if selected source = M&B Ext)	Ratio B+M=<measured>	
Width	Width=<measured>	

When the reference is a nonzero value, it is shown on the left and the delta result is shown on the right of the display. A capital Greek delta (Δ) is displayed to the immediate left of the measurement name (e.g., Δ Freq) except for **Total** which has no ref value. Table 2-29 shows the format for nonzero reference values or when the NUMERIC ENTRY menu is on. This table also shows the displayed results of measurements and reference values.

When the NUMERIC ENTRY menu is displayed, it is treated as if the reference value is not zero. This offers you the choice to enter something for the reference. See the "NUMERIC ENTRY" subsection for target detail.

When **Null** on the Numeric keypad menu is touched, the present values for the measurement displayed are saved and subtracted (nulled) from all following measurements of that particular type. When **Clear** and **Enter** on the Numeric keypad menu are touched, the reference is set to zero and the measured results are displayed again as "absolutes." In addition, any valid number entered from the Numeric Keypad menu is interpreted as a new reference value and displayed in the readout.

TABLE 2-29
Format for Nonzero Reference or NUMERIC ENTRY On

Selected Measurement	Display	
	Left Half	Right Half
Time A→B (if D1 & D2 sweeps are in use and source=Swp Start)	Δ Time D1→D2=<measured-Ref>	Ref=<entered>
(if only one delayed sweep is in use or Ext A→B is selected)	Δ Time M→D=<measured-Ref>	Ref=<entered>
(if source=M&D Trigs)	Δ Time M→D=<measured-Ref>	Ref=<entered>
Frequency	Δ Freq=<measured-Ref>	Ref=<entered>
Period	Δ Period=<measured-Ref>	Ref=<entered>
Total (if selected source = A&B Ext)	Total A=<measured>	Total B=<measured>
Total (if selected source = A Ext)	Total A=<measured>	Elapsed=<measured>
Total (if selected source = M&D1)	Total M=<measured>	Total D1=<measured>
Total (if selected source = M Trig)	Total M=<measured>	Elapsed=<measured>

TABLE 2-29 (cont)
Format for Nonzero Reference or NUMERIC ENTRY On

Selected Measurement	Display	
	Left Half	Right Half
Ratio (if selected source = A&B Ext)	$\Delta\text{Ratio } B+A = \langle \text{measured-Ref} \rangle$	Ref = $\langle \text{entered} \rangle$
Ratio (if selected source = M&D1)	$\Delta\text{Ratio } D1+M = \langle \text{measured-Ref} \rangle$	Ref = $\langle \text{entered} \rangle$
Ratio (if selected source = M&B)	$\Delta\text{Ratio } B+M = \langle \text{measured} \rangle$	Ref = $\langle \text{entered} \rangle$
Width	$\Delta\text{Width} = \langle \text{measured-Ref} \rangle$	Ref = $\langle \text{entered} \rangle$

Whenever the measurement source is changed or Enhanced Accuracy, Measure, or Autoset is executed, the displayed results are cleared and the measurement in progress (except for **Total**) is aborted and restarted. The result for **Total** remains cleared with a message advising you to start again as the old result was disturbed. This tends to eliminate misleading and false measurement results when the source is changed.

Modifying any of the trigger controls or trigger source inputs for the selected measurement source (e.g., **Main** or **Dly1** trigger source menus) by selecting a new measurement source (e.g., **Main Trig**, **A Ext**, etc.) can disturb a measurement. Therefore, the measurement will be aborted and restarted.

Pressing RESET always clears the displayed results and reinitiates the measurement.

Additional Control and Status

Time A→B can measure the time difference from an event of one signal to an event of another signal. You should be aware of the dependency upon the Delayed trigger definitions when using **Time A→B** with *Source* equal to **Swp Start** and the delayed windows set to **Trig'd After Delay**. This means that the Delayed trigger sources are alternated to allow timing between two different signals. If **Runs After Dly** is used, the trigger sources are not important.

Another case is when Main and/or Delayed trigger sources are used for the **Ratio**, **Frequency**, **Period**, **Width**, or **Total** measurements. Here you are required to set, through the TRIGGER SOURCE menu, the trigger sources you wish to measure.

If either of the Delayed triggers is used as a measurement source, the **Trig'd After Dly** source must correspond to the measurement source.

Counter View Traces

Through the Counter/Timer, several different signals can be viewed to interpret measurement results. All counter-view signals are binary, that is, they have only two possible vertical states. Their significance is in the timing of the transitions.

Counter-view signals are displayed in the same manner as any new trace by using the WAVEFORM major menu. This means that they will occupy a touch zone in the trace description area. VERTICAL OFFSET and SIZE, and the trace construction operators +, -, and VS cannot be used on Counter View traces. However, delayed windows can be created on Counter View traces and VERTICAL POSITION can be used. The following entries in the WAVEFORM menu (as shown in Fig. 2-61) will help you in operating the Counter/Timer.

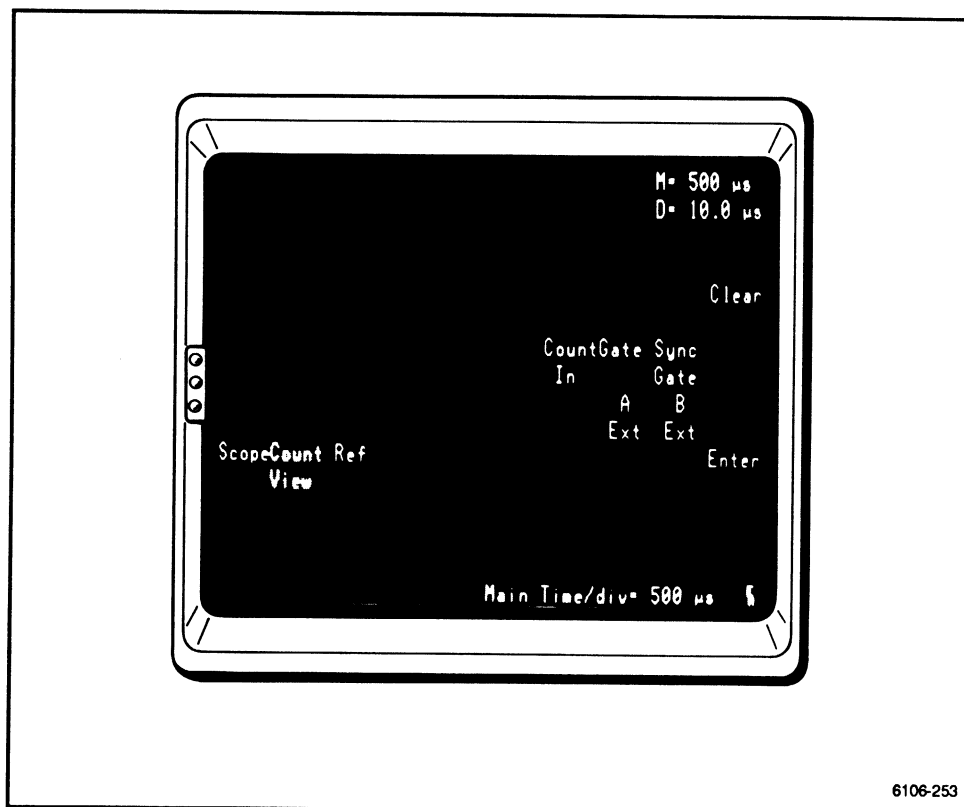

6106-253

Figure 2-61. The WAVEFORM menu shows the additional entries from the counter-view signals of the Counter/Timer.

Count In—represents the signal counted as a binary signal (only two vertical states). When the counter is being gated, this trace shows the "gated input" to the counter. When not gated, this trace shows the same number of transitions as the detected input signal.

Sync Gate—views the interval actually being measured except for Time A→B. For Time A→B with the source set to M&D1 Trig, Sync Gate represents the measurement beginning at the Main trigger and ending at the Dly1 trigger.

All Counter/Timer measurements begin and end on transitions of the signal being measured. The gating signal may be unrelated to the measured signal resulting in the actual gated measurement beginning on the first edge of the signal after the start of the gate, and then ending on the next edge after the end of the gate. See Figure 2-62.

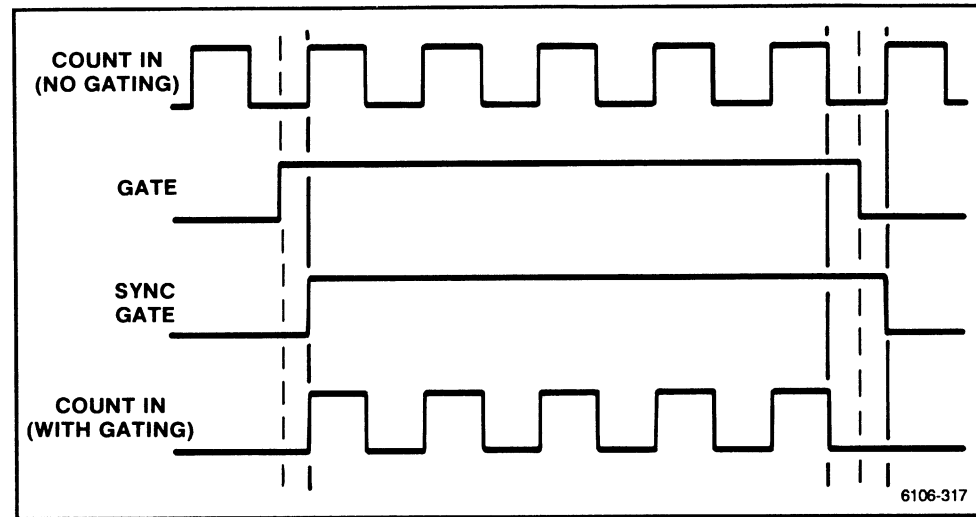

Figure 2-62. The relationship of Sync Gate to the gating signal and the measured signal.

Gate—views the applied gate that you can select as either the Delayed time-base sweep gate or the B Ext input.

To summarize the last three choices, **Count In** is what the counter counts, **Sync Gate** is the actual measurement interval, and **Gate** is the gating signal that, in conjunction with the input to the counter, defines the measurement interval. These three counter views are most useful for Frequency, Period, Width, Ratio, and Total. For Time A→B, these provide little insight into the measurement. All of these traces have only two vertical levels; therefore, they are binary representations of their respective signals.

A External Input—views the detected signal present at the A External input of the mainframe.

B External Input—views the detected signal present at the B External input of the mainframe. Counter View displays of A & B External are available at all times whether or not they are being used for measurements. The Counter View signals displayed as **Count In**, **Gate**, and **Sync Gate** depend on the measurement being made. See Table 2-30.

TABLE 2-30
Synopsis of Counter Views

MEASURE	COUNT IN Without Gating	COUNT IN With Gating	GATE	SYNC GATE
Freq/Period	Measurement Source	Gated Measurement Source	Gating Source	Synchronized Gate Source
Width	Measurement Source	Gated Measurement Source	Gating Source	Synchronized Gate Source
Ratio	Measurement Source	Gated Measurement Source	Gating Source	Synchronized Gate Source
Total	Measurement Source	Gated Measurement Source	Gating Source	Gating Source
Time A→B Internal M→D1	Measurement Clock*	—	M→D1 Time	Gating Source
Time A→B Internal M→D2	Measurement Clock*	—	Measurement Clock*	Measurement Clock*
Time A→B Internal D1→D2	None	—	None	None
Time A→B External	Measurement Clock*	—	Measurement Interval	Measurement Interval
Time A→B M&D1 Window1 on	Measurement Interval	—	Measurement Interval	Measurement Interval
Time A→B M&D2 Window2 on	Measurement Interval	—	Measurement Interval	Measurement Interval

* The measurement clock is the 555 MHz timing reference counted during the Main to Delay sweep time. It serves as an aid in positioning the Delayed windows at the fast main sweep speeds.

Presentation of Results

Frequency, Period, Ratio, Time, and Width

The measurement results for **Frequency, Period, Ratio, Time, and Width** are always scaled as a mantissa (M) with an exponent symbol (S) and dimension (D) using SI (Système International d'Unités) conventions where:

$$1 \leq M < 1000 \text{ and}$$

$$S = f, p, n, \mu, m, k, M, G, T, (\dots\text{etc.})$$

$$D = \text{Hz and s}$$

In some cases, there may not be enough resolution to accurately represent the measurement. For example, a single shot measurement of 120 MHz would produce either 111 or 138 MHz result from the counter. Under these or any other conditions where there are fewer significant digits than required to place the decimal point to the right, only the significant digits appear on the display with all digits to the right of the decimal point.

In the case of the example above, the result would be displayed as 0.1 GHz. In general, the result will be tested for enough significant digits to fit the general display format. If there are not enough digits to fill the format, then the following adjustment to the format will be made.

The mantissa, M, will be displayed as:

$$0.001 \leq M < 1$$

The exponent symbol, S, will represent a 1,000 times increase. In other words, divide the mantissa prescribed by the general form by 1,000 and multiply its associated exponent by 1,000.

Tables 2-17, 2-20, 2-23, and 2-24 list the number of digits available as a function of frequency and amount of averaging. These apply whether or not you are using *Gating*.

When averaging is increased the number of displayable significant digits usually increases. For example, 5.0 MHz would appear as:

old reading:	5.0 MHz (2 sig. digits with Averages set to 1)
new reading:	5.000 MHz (4 sig. digits with Averages set to 100)

It is also possible to have the number of displayable digits change due to a change in frequency. For example, a frequency change from 2.4 MHz to 2.30 MHz appears as:

old reading:	2.4 MHz (2 sig. digits with Averages set to 1)
new reading:	2.30 MHz (Averages still set to 1 but the lower frequency allows one more digit to be shown)

The maximum number of digits displayed for the **Frequency**, **Period** or **Width** time interval is reduced to seven when the oven-stabilized internal reference is not used. When **External** is selected for the clock source, the maximum number of significant digits is ten.

Total

The results for **Total** are presented as an integer of ten digits or less. If the value exceeds the ten digit display, exponent scaling (scientific notation) is applied. This, in effect, acts like a prescaler allowing you to continue to view the result without overflowing the display. The results are dimensionless.

Ratio

The results of Ratio are presented with ten digits. Leading zeros for results <1 are not counted as significant digits.

Counter/Timer Concepts

This is a discussion on the principles and capabilities of using the Counter/Timer features. Refer to "Counter/Timer" in this subsection for specific information on counter and timing operations by menu selection and external inputs. Refer to the "Measurement Concept Tutorial" subsection for more Counter/Timer examples.

Description

The 11301 and 11302 Programmable Oscilloscopes each contain a high performance Counter/Timer. By taking advantage of oscilloscope resources such as delayed sweeps, multiple trigger inputs, high sensitivity inputs, and a crt display, this becomes a true precision measurement instrument.

To appreciate the benefits that these resources provide when used with the Counter/Timer, a brief discussion of the oscilloscope architecture is helpful.

Figure 2-63 shows a simplified block diagram of the internal instrument architecture. The bold lines in this diagram represent the paths that relate directly to the Counter/Timer. Such paths include analog signal sources to be measured, processed and detected signals from the triggers, measurement delimiters, and a way to view not only the numeric results but to see how the signals actually appear from the point of view of the counter.

Counter View Display

The "Counter's View" of the signal can be used to determine which features of the signal are being measured. This added display allows you to adjust and control the measurement with greater precision.

Displaying Counter View Traces

Displaying the Counter View signal reveals what the counter is actually "seeing" and how it's being interpreted. The most valuable of these signals is the **Count In** signal, which represents the information the counter received from the selected trigger source. Other counter views include signals representing the applied **Gate**, which can be used to exclude and mask-out unwanted waveform features from the measurement; the **Sync Gate**, which indicates the interval within which the counter actually performs the measurement; and the **A Ext** and **B Ext** inputs as detected by the CT Ext trigger controls. **A Ext** and **B Ext** inputs are most easily viewed when they are time related and when the Main trigger has **A Ext** selected as its source.

In a conventional oscilloscope, the triggering circuitry is used to provide a stable display of a signal. The triggers produce a processed signal that represents the detection of a signal transition having some predescribed level and direction (polarity). These, of course, are determined by the familiar Trigger Level and Slope controls or by invoking Autoset for the Main and Delayed trigger sources.

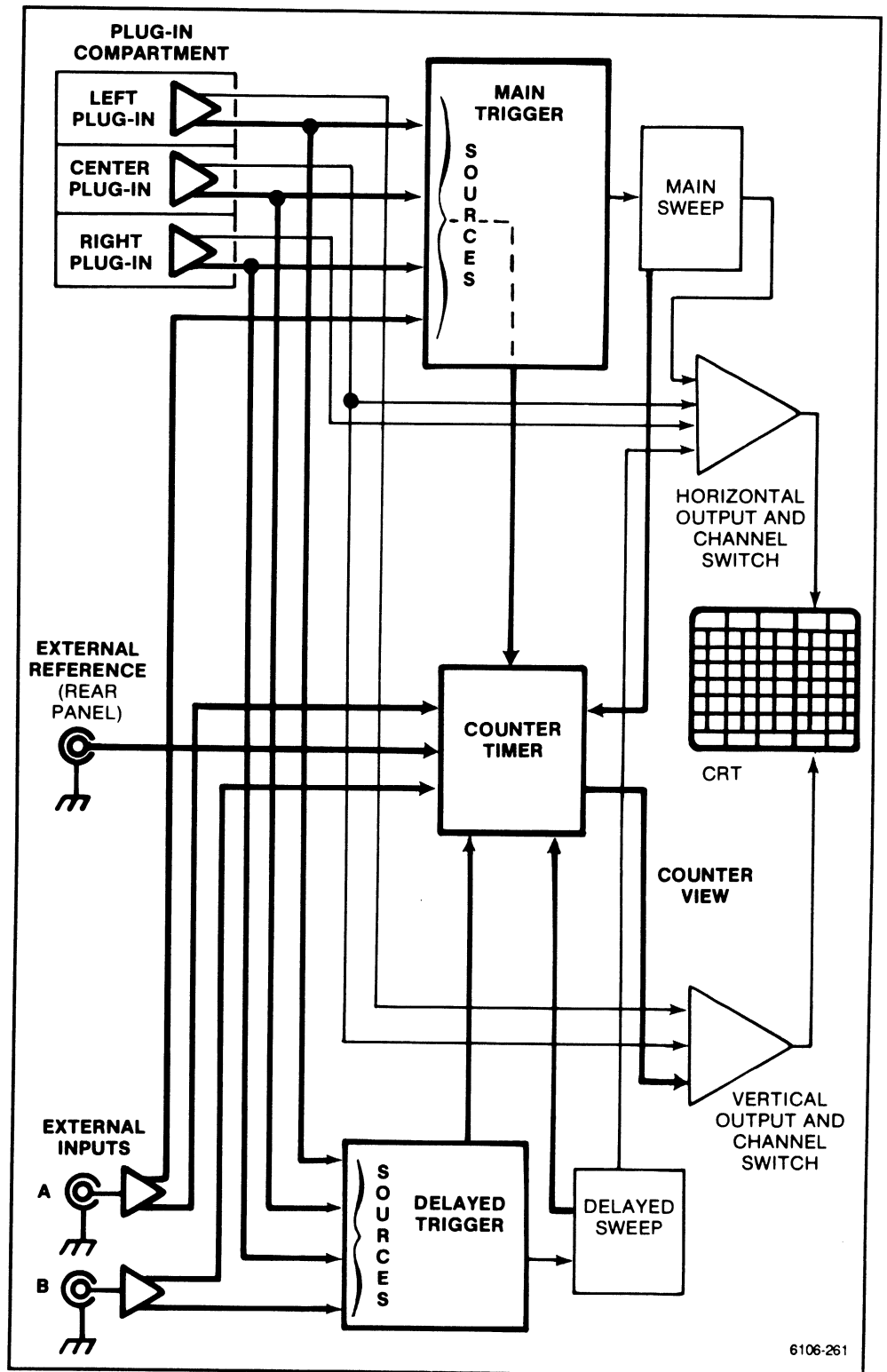

Figure 2-63. Simplified Block Diagram with highlighted Counter/Timer paths.

The trigger output signal is simply a series of high to low transitions. These are what most of the measurements of the Counter/Timer are based on. (The one exception is Time A→B with **Swp Start** as the *Source* and the delayed sweep set to **Runs After Dly**). Therefore, by adjusting the trigger level and the slope, different characteristics of a signal can be measured.

Viewing the **Count In** signal can lend more insight into a measurement even for seemingly simple waveshapes. For signals other than square wave signals, the placement of the trigger level can have a subtle effect upon the measurement. This will have a more profound effect when making a pulse-width measurement on a signal with appreciable rise and fall times.

A signal appearing to be symmetric about its middle level, such as a sine wave, may look quite different to the counter depending upon where the trigger level is set. For example, if the trigger level is set to 25% of peak-to-peak from the top of the signal, the detected signal as viewed by the counter will have a duty factor of about 33% (see Fig. 2-64). This means that the width of the signal appears to be two-thirds the value of what would be measured at the mid (50%) point of the signal. All of this may seem a bit unsettling for such a simple waveshape, but by displaying the **Count In** signal, such a situation can be easily observed.

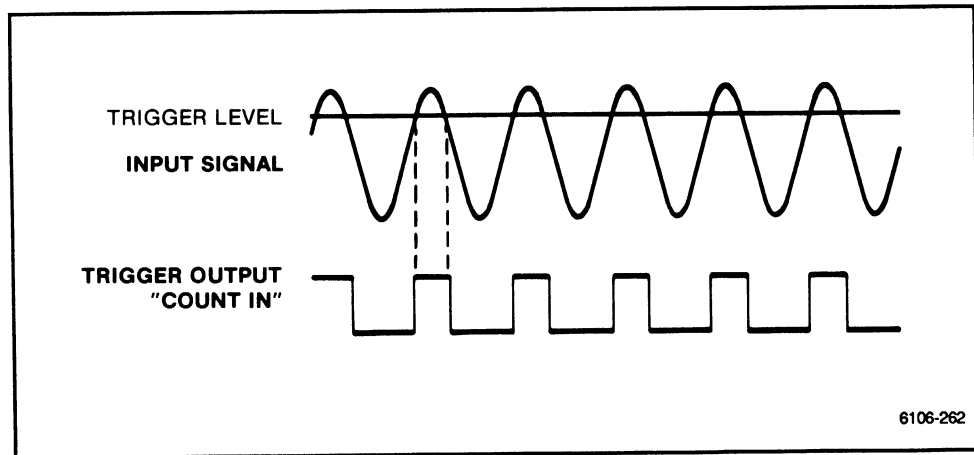

Figure 2-64. Counter View Traces.

Measured Signals

Signals to be measured can originate from the A and B External inputs or from the plug-in compartments. Allowing the signal to be first applied to and amplified by a plug-in unit extends the usefulness of the Counter/Timer. For example, high impedance sources can be examined by using a very low loading probe. Also, signals of irregular and aperiodic components with large dc components can be centered within the triggering range of the Counter/Timer by using an differential comparator amplifier. Such a plug-in can compensate for dc components of 10,000 times the magnitude of the ac component. This feature is not available with any conventional Counter/Timer.

The amplified signal from the plug-in has two different paths. It can be viewed on the display, examined by the trigger circuits, or both. It is important to realize that the signal to the trigger circuits does not have to be from the same source as the signal being displayed. For example, a displayed trace originating from the LEFT compartment can be triggered by a signal from the CENTER compartment. Also, within a given plug-in, one channel can be viewed while another undisplayed channel can be used for triggering.

To define trigger sources for the Main and Delayed time bases, the TRIGGER SOURCE major menu is used.

Measurement Intervals

The Counter/Timer offers several ways to control when measurements are made. In the human time frame, the *Update* setting controls when the measurements will be initiated by the processor within the instrument. Measurements may be started individually using RESET with **Manual Update** or allowed to repeat after completion with the processor limiting the update interval to 300 ms (for convenient visual monitoring of the result when using **Auto Update**).

When a more precise setting of the measurement interval is required, *Gating* may be used. Measurement gating is available for Frequency, Period, Width, Ratio and Total measurements. Time A→B measurements may not be gated. Gated measurements begin on the first transition following the start of the gate interval and end on the first transition after the gates end. The Counter View may be used as an aid in understanding where gating occurs, especially using the **Sync Gate** to show the realignment of the gate to the signal (**Count In**). Averaged measurements will continue until the end of the current gate interval after the number of averages has reached its selected value. Gating does affect the measurement results in that a one count error may occur for each gate that without gating would occur only once for each measurement. Gating sources provide three different ways to select the actual measurement interval.

Delayed sweep gating using the Dly1 window is, perhaps, the most convenient way to gate a measurement. Gating may use either **Runs** or **Trig'd After Delay**. It is often easier to position the gate using **Runs After Delay** then switch to **Trig'd After Delay** if it is still necessary. It is not necessary to turn on **Window1** unless you want to have the approximate gated area intensified on the Main sweep. Delay 1 may be set to position the gated measurement interval anywhere on the main sweep after about the first 100 ns of a visible main sweep on the screen. Allowing a typical setting of less than 150 ns, the gate interval will last the duration of the delayed sweep. At slower sweep speeds, it is approximately ten times the delayed Time/div setting.

The CT External A and B inputs may be used as a pair to determine the beginning and end of the gate interval. The A input starts the gate with the B input ending it. A positive transition will be the active edge with a + slope setting.

The CT External B input may be used by itself to develop a gate interval that occurs when the input is above the setting of the CT Ext B level with a + slope selected or when the input is below the setting of the CT Ext B level with a – slope selected.

Measurements do not start immediately, however. They are only permitted to start only after the trigger conditions are satisfied.

Once permitted to start, the measurements must again be inhibited at the end of the gate interval. This length of time is determined by the delayed sweep time, approximately ten times the Delayed Window Time/division setting.

The External A and B inputs can also be used to gate a measurement.

Frequency Measurements

For well-behaved and periodic signals, only a few special considerations are needed. For more complex signals and discriminating techniques, see "Gated Frequency Measurements" that follows.

First of all, it's important that the signal to be measured have sufficient amplitude and stability to produce accurate counter results. This does not mean that these are the only signals that can be measured. For this example, such a signal will serve as an effective vehicle. Second, the trigger source gets its signal from the counter not from the display directly.

The easiest way to ensure that the signal amplitude and triggering are correct is to use AUTOSET. Remember that AUTOSET, when fully enabled, adjusts the input sensitivity, input offset, input coupling, all of the triggering, and, most importantly, makes the trigger source the same signal as the one that gets automatically scaled. By using AUTOSET, all of the adjustments prior to making a frequency measurement on simple signals are made automatically.

After the trace and triggers are set, pressing the COUNTER button (located below the display) accesses the Counter/Timer menu. Here several different measurements can be selected. By repeatedly touching the menu item labeled *Measure* (located in the lower right corner of the display) the desired measurement and its associated parameters can be selected. In this case, keep touching *Measure* until **Frequency** is selected as the measurement.

To simplify the counter operation, several **Auto** selections are available for most of the measurement parameters. In the COUNTER menu, *Update* controls whether the results will be continually reported (*Update=Auto*) or reported only once and remain frozen in the display (*Update=Manual*). The measurements and the present results can be aborted (cleared) and restarted by pressing the trigger RESET button located below the crt. To control the resolution (number of significant digits), the number of measurement averages can be selected. When *Averages* is set for **Auto**, the number of averages will depend upon how many can be performed within about 0.3 seconds. This will permit the display to be updated several times each second when using **Auto Update**.

The *Gating* selection should be set to **Off** for simple signals. Its primary use is to discriminate and exclude events or waveform characteristics from the measurement. See "Gated Frequency Measurements" for more information.

The *Source* selection in the counter menu allows for choosing which trigger signals to use. These can be the detected output from the Main trigger (**Main Trig**), Delayed trigger number one (**Dly1 Trig**), Delayed trigger number two (**Dly2 Trig**), and the A External input to the counter (**A Ext**). As this is not altered by the Autoset feature, special care must be taken to make sure that it is set to the desired trigger source. Selecting **Main Trig** as the source when using Autoset is a simple way to minimize manual adjustments.

Gated Frequency Measurements

Measuring the frequency of complex signals such as bursts requires some special considerations. First, always display the counter view signal called **Count In**. This can be selected for display from the WAVEFORM major menu. As the trigger level is adjusted, the **Count In** signal shows the detected transitions. These transitions are what is measured.

In Figure 2-65, two bursts of different duration are detected by the trigger, which results in a series of pulses as shown by the trigger-view trace. As the counter averages these pulses over a fixed interval of time, it will measure a frequency lower than the frequency within the bursts. To get the proper frequency result, the time interval of the measurement must be confined to the burst of interest.

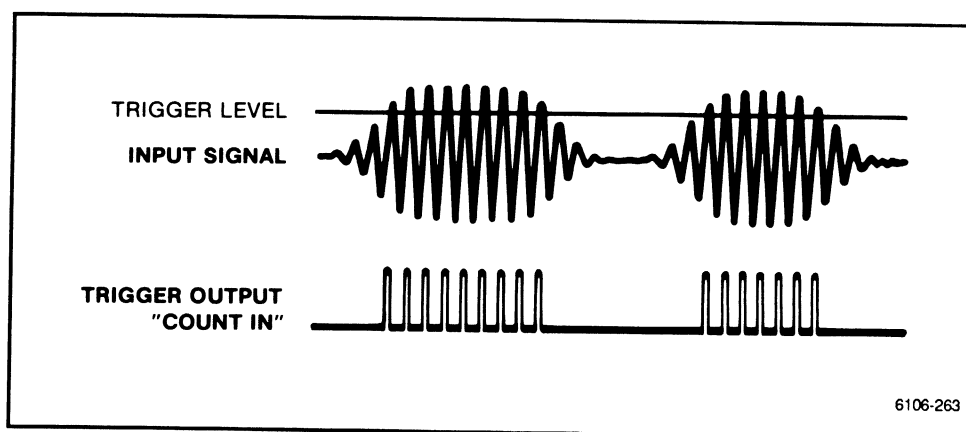

Figure 2-65. Trigger View trace shows pulses derived from two bursts of different durations.

The easiest way to do this is to select **Dly1 Swp** for gating in the COUNTER menu. This allows for control through adjusting the delayed time-base duration (Time/div) and delay reference number one. The best way to view this gate is to display the counter view signal called **Gate**.

Figure 2-66 shows the **Gate** and the **Count In**. When the gate is adjusted to align with the burst, the counter will "see" only the pulses shown as the Count In signal. The measurement interval, now confined to the burst, results in the proper frequency calculation.

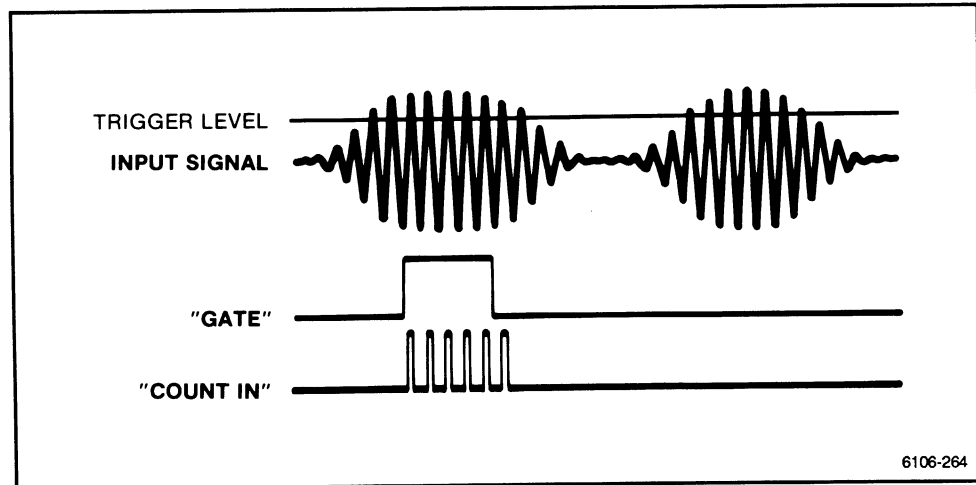

Figure 2-66. Gate and Count In pulses.

Input Coupling, Noise, and Attenuation

If using **AC Coupling** and the signal frequency or duty cycle changes, the triggering point may shift. This can produce measurement errors. You should use the **DC Coupling** for low frequency ac signals, signals with a low duty cycle, and during any Counter/Timer time interval measurements (Time A→B and Width).

Noise may be present at the input amplifiers along with the signal to be measured. Noise may originate from the operating environment, the signal source, or improper connections. If the noise is of sufficient amplitude, it can result in inaccurate measurements due to false triggering. See Figure 2-67.

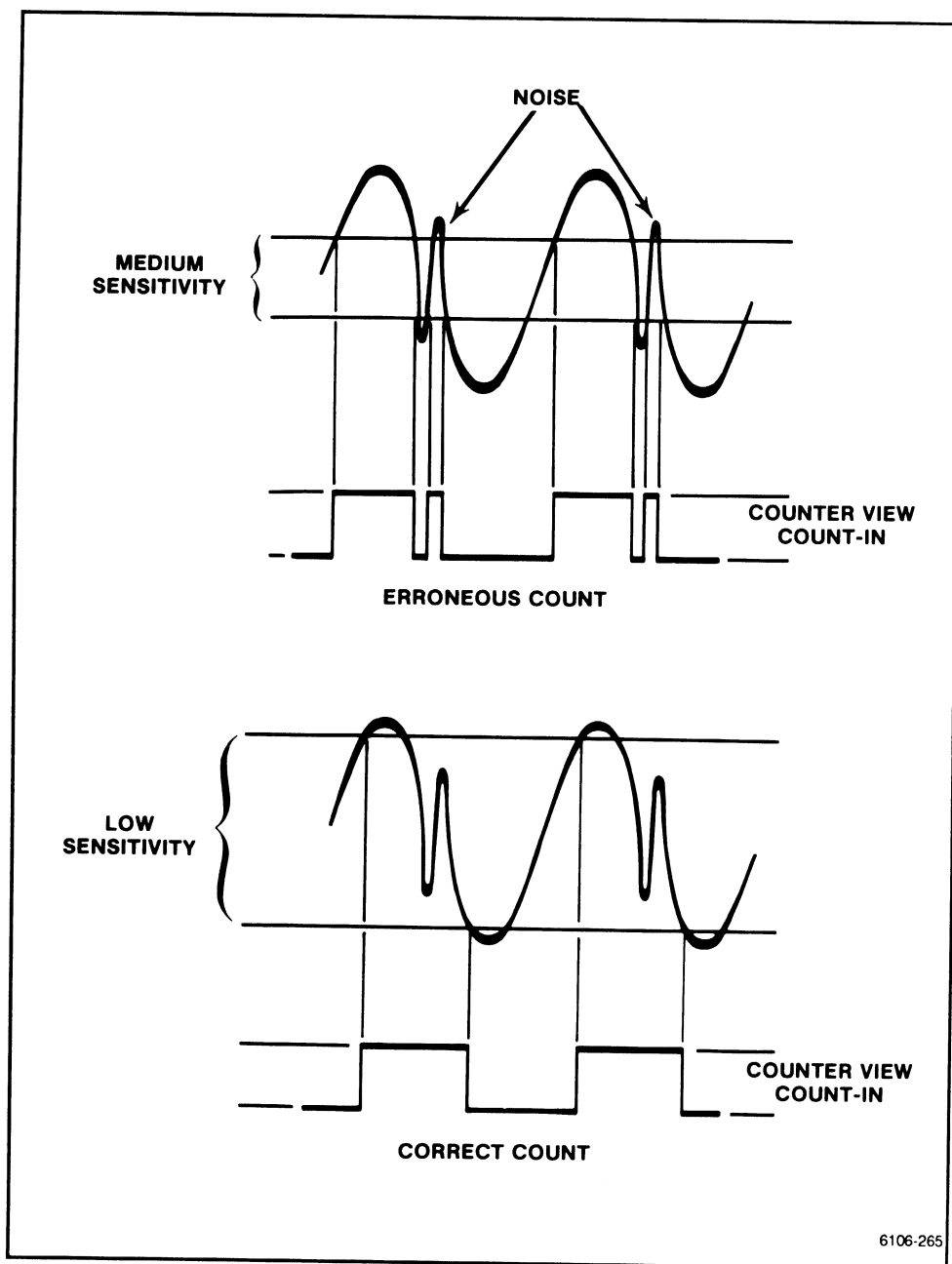

Figure 2-67. One advantage of selectable trigger sensitivity.

Nulling the Counter/Timer

Measurements are often compared to each other or to some previous result. This is a common practice when testing the stability of a particular electrical characteristic among several seemingly identical devices. To facilitate such comparisons, some Counter/Timers provide a feature called "nulling," which allows you to specify a reference to which all measurements will be compared.

The term nulling comes from the method used to establish the reference value. An actual measurement is made, then saved and subtracted from all measurements. The result is a measure of deviation. For example, if you wanted to know how a frequency varies over the course of an experiment, you can first make a reference measurement and save the result as a standard for comparison. Future frequency measurements will be presented as Δ Frequency showing either a + or - result.

The Counter/Timer of this instrument goes one step farther. With the NUMERIC ENTRY major menu, any arbitrary value can be quickly entered and established as a reference for comparison.

Nulling by establishing and using reference can be applied to all of the Counter/Timer measurements except the Total measurement. This feature of nulling allows relative results of Δ Frequency, Δ Period, Δ Width, and Δ Ratio. Nulling is especially useful for nulling the differences in electrical lengths of attached probes and cables when making time interval measurements between two different oscilloscope inputs.

Whenever a nonzero reference value is present, the measurement results will always present the nulled relative value as well as the reference value.

Reducing Measurement Errors

As an aid in reducing measurement errors, remember the following factors.

- Use a high impedance probe with a high impedance circuit. See "Coaxial Cables and Probes" in the "Measurement Concept Tutorial" subsection.
- Use the 50 Ω termination for low impedance, high frequency 50 Ω systems.
- Consider trigger errors caused by input signals with slow rise or fall times.
- Use **Auto Averages** if uncertain of the frequency of the signal being measured.
- If using Option 1T (high-stability oven oscillator), keep the PRINCIPAL POWER SWITCH on for at least two days to ensure maximum stability. The front panel ON/STANDBY switch does not affect stability.

Time Interval Measurements

Two types of time interval measurements may be made with the Counter/Timer. The source selected determines the type of Time A→B measurement to be made. Averaging and Update operate the same for both types of time interval measurements as it does for all other types of measurements. A 555 MHz clock is used as the time reference for 1.8 ns single measurement resolution. Averaging extends the resolution to beyond 10 ps.

The first type of time interval measurement is Time A→B with **Swp Start** selected as the *Source*. This measurement type allows complex time interval measurements to be made with the aid of the Delayed sweep. Measurements begin at the start of the Main sweep and end at the start of the Delayed sweep. Time A→B mode offers the unusual ability to synchronize the main sweep with complex signals. Such synchronizing ability results from the variable delay of the Delayed sweep and the variable trigger Holdoff time of the Main and Delayed sweeps. The adjustable slope and level of the Delayed sweep allows the end of the measurement interval point on a waveform to be independently set with respect to the starting point.

The ability to define two windows on the Main sweep adds even more capability. The Counter/Timer will automatically subtract the time measured between the start of the Main sweep and Window 1 from the time measured between the start of the Main sweep and the start of Window 2. (There are limitations. When **Swp Start** is selected as the measurement source, the minimum time interval from Main to Dly1 or Dly2 sweep starts is 70 ns. However, the difference between Dly1 and Dly2 may be zero. See Figure 2-68.) Each window may have its delay time, source, level, and slope set independently for complete flexibility in setting the measurement interval. The intensified zones begin at approximately the same time as the Delayed sweep begins. By this means, the intensified zones can be used as markers to locate waveform features while the Counter/Timer measures the time between them. At faster Main sweep speeds, where the intensified zone is less well defined, the Counter View may be used to aid in the selection of the measurement interval.

The other type of Time A→B measurement has the Main and Delayed triggers or the CT External A and B as its input pairs. The time interval measured occurs between edges of the selected pair of inputs. The slope selection allows you to invert the transition direction that begins and ends the time interval; + slope corresponds to positive transitions. The Level setting for these measurements from the Main and Delayed trigger sources use the same slope and level setting as used in triggering the sweeps. The slope and level settings for the CT Ext A and B inputs can be set independently. Using these inputs allows measurements to be independent of traces and other trigger sources. The **A Ext** and **B Ext** traces in the *Count View* waveform menu may be used as an aid in setting the slope and level of these inputs. A minimum time interval of 2 ns is required when using these inputs. The time between measurements may be less than 10 ns when using averaging as this increases resolution. Many averages may be made in a short time.

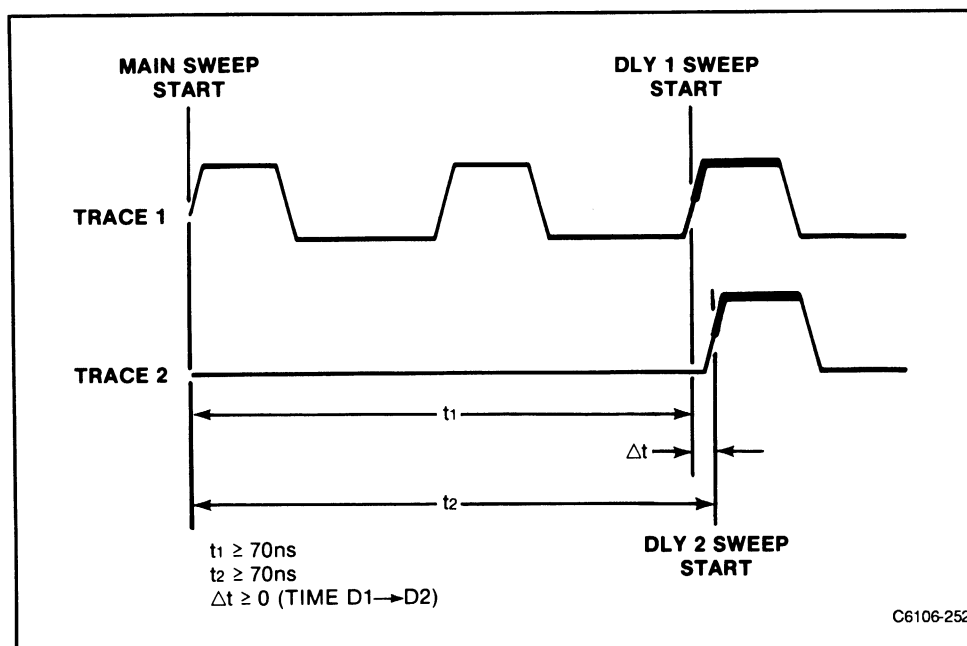

Figure 2-68. Precision timing between any two events is provided when using both Window 1 and 2. The difference between Dly1 to Dly2 equal to zero.

Also, the time from the Main trigger to the Dly1 trigger can be measured if **M&D1 Trig** is selected. This differs from Swp Start in that **Swp Start** can be used to make measurements between any two points on one or two waveforms. **M&D1 Trig** measures the time between adjacent Main and Dly1 trigger events. It is completely independent of the Main and Delayed sweeps. However, adjusting the Main and Dly1 trigger slope, level, coupling, and source may be required. When using **M&D1 Trig** as the Time A \rightarrow B source, use the **Sync Gate** counter-view trace to view the measurement interval.

When **Swp Start** is selected as the Time A \rightarrow B source, counter-view traces provide little additional information over the delayed windows and intensified zones. It is recommended that counter-views not be used when **Swp Start** is selected as the measurement source.

Cursors

Cursors are lines that serve as calipers. Cursors can be positioned arbitrarily on the crt. With cursors you can measure vertical or horizontal displacement and the oscilloscope does the calculations. Because the scale factors and dimensional units of the cursors depend on the source of the display, the oscilloscope extracts the needed information from the plug-ins.

When displayed, a solid line and a dashed line will appear. The solid line is always controlled by the left knob; the dashed line is controlled by the right knob.

Cursors Menu

The Cursor menu (see Fig. 2-69) is generated by pressing the CURSOR button on the front panel. Tables 2-31 through 2-34 show the Cursor menu choices.

Cursors Selected For Horizontal

The horizontal cursors (two vertical lines) display delta horizontal and $1/(\Delta \text{Horizontal})$ for a YT trace (see Fig. 2-69), but for an XY trace (see Fig. 2-70) they display delta horizontal and the difference between the solid cursor (cursor number one) and the horizontal zero reference. Because in a typical XY display both dimensions are derived from plug-in amplifiers, whatever is possible for the vertical reference is possible for the horizontal. Delta readings are always computed as the value of the solid cursor subtracted from the value of the dashed cursor. If dB scaling is selected for an XY trace, the Horizontal cursor readings are computed in the same manner as the Vertical cursor reading.

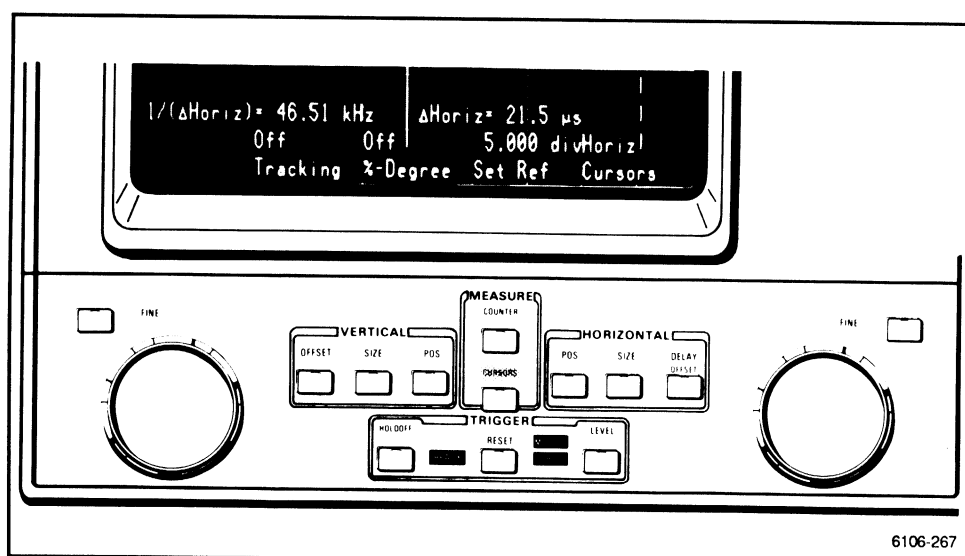

Figure 2-69. Horizontal CURSORS menu with a YT trace selected.

If % Degree is selected for a YT trace, the percent and degree are computed as follows:

$$\Delta\text{Horiz}(\text{percent}) = \frac{\text{ABS}(D_2 - D_1)}{\text{Ref Mag}} (100)\%$$

$$\Delta\text{Horiz}(\text{degree}) = \frac{\text{ABS}(D_2 - D_1)}{\text{Ref Mag}} (360)^\circ$$

Where:

Ref Mag = magnitude (in divs) established when *Set Ref* is touched.

$D_2 - D_1$ = displacement difference (in divs) between cursors.

ABS = Absolute value.

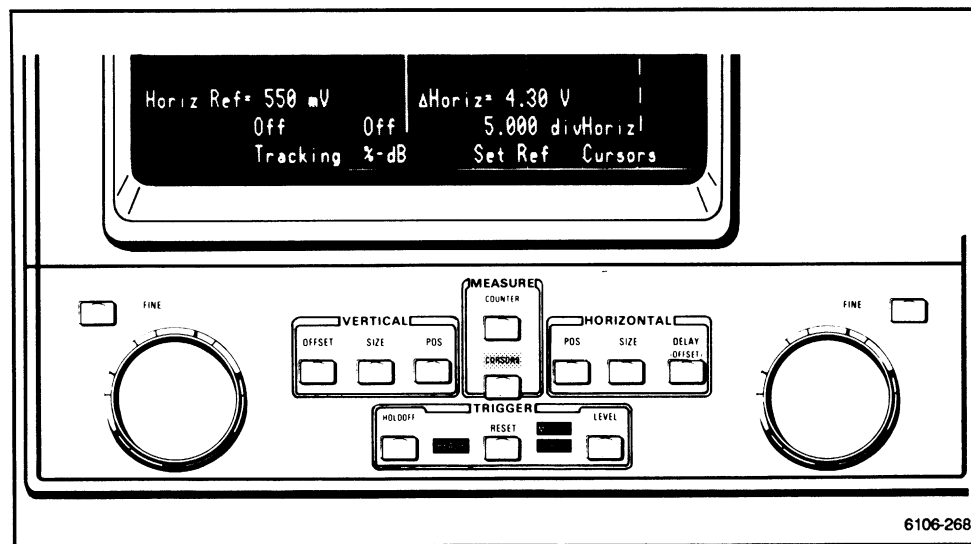

Figure 2-70. Horizontal CURSORS menu for an XY trace.

TABLE 2-31
Horizontal Cursor Measurements for YT Traces

Tracking	% Degree	Set Ref	Cursors
On Off	On Off	Value in divs Value in divs	Horizontal

Repeatedly touching a menu function on the screen cycles through all possible choices.

TABLE 2-32
Horizontal Cursor Measurements for XY Traces

Tracking	% dB	Set Ref	Cursors
On	On	Value in divs	Horizontal
Off	Off	Value in divs	

Repeatedly touching a menu function on the screen cycles through all possible choices.

Cursors Selected for Vertical

The vertical measurement cursors (two horizontal lines) display the delta vertical value (the difference between the two cursors). (See Fig. 2-71.) If the input is dc coupled, the difference from the solid cursor (cursor number one) and the vertical zero reference is displayed. If the input is ac coupled or if the vertical expression is a combination of inputs, input offset is ignored and assumed to be zero in the calculation that follows.

The vertical reference is derived from the known input offset and the known display position. This is given by the following formula:

$$\text{Vert Ref} = (\text{Vert Scale/div}) \times (D_1 - \text{Pos}) + \text{Offset}$$

Where:

D_1 = Displacement of the solid cursor from center screen in divisions (positive above center, negative below).

Offset = Input offset (scaled, not divs) applied to the signal.

Pos = Vertical Position value in divisions.

If the selected trace is an inverted channel (e.g., -L1), then the cursor scaling is also inverted. For example, moving the solid cursor downward will increase the reading as this is the direction of more positive signal.

If dB scaling is selected, the values of percent and dB are computed as follows:

$$\Delta\text{Vert}(\text{percent}) = \frac{\text{ABS}(D_2 - D_1)}{\text{Ref Mag}} (100)\%$$

$$\Delta\text{Vert}(\text{dB}) = 20 \log \left(\frac{\text{ABS}(D_2 - D_1)}{\text{Ref Mag}} \right) \text{ dB}$$

Where:

Ref Mag = magnitude (in divs) established when *Set Ref* is touched.

$D_2 - D_1$ = displacement difference (in divs) between cursors.

ABS = Absolute value.

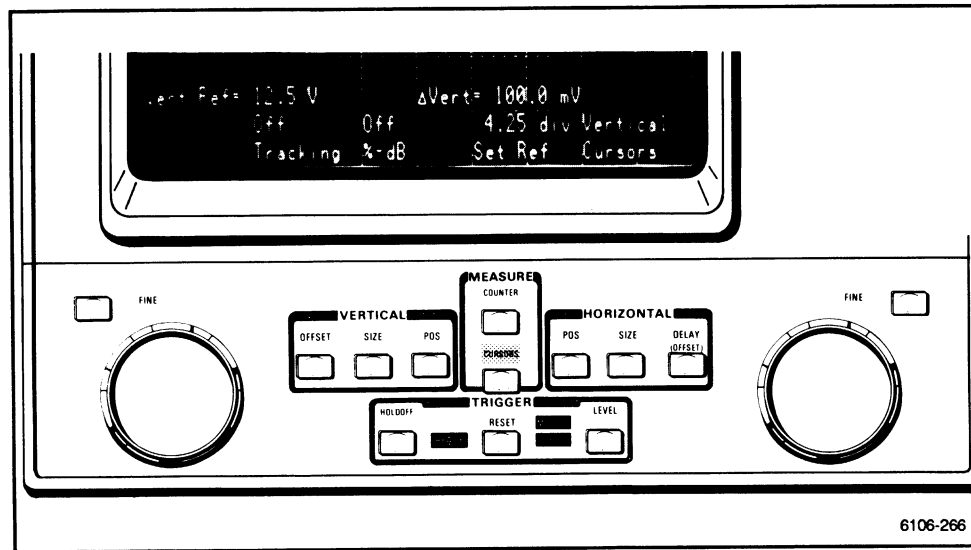

Figure 2-71. Vertical CURSORS menu.

TABLE 2-33
Vertical Cursor Measurements

Tracking	% dB	Set Ref	Cursors
On	On	Value in divs	Vertical
Off	Off	Value in divs	

Repeatedly touching a menu function on the screen cycles through all possible choices.

Cursors When Off

Cursors may be turned off. When Cursors are selected to be **Off**, then no menu choices are displayed.

Tracking and Nontracking Cursors

The Cursor Position *Tracking* can be either **On** or **Off**. When *Tracking* is **Off**, the left knob controls the solid cursor and the right knob controls the dashed cursor. When *Tracking* is **On**, the left knob controls the position of both cursors while maintaining a constant displacement between them. The right knob controls the displacement between them by moving the dashed cursor.

Set Ref

To establish a reference magnitude for the percent and dB or the percent and degree scaling, you adjust the cursor lines to the desired separation then touch *Set Ref*. The new reference magnitude is displayed, in divisions with resolution to 0.01 div, as the status over *Set Ref*.

Scaling

The results of the cursor calculations can be scaled in the dimensions (volts, amps, time, etc.) as derived from the selected trace, or scaled relative to your established reference magnitude. For the vertical cursors, the alternate scaling is in percent and dB (see Fig. 2-72). For the horizontal cursors on an XY trace the alternate scaling is also percent and dB.

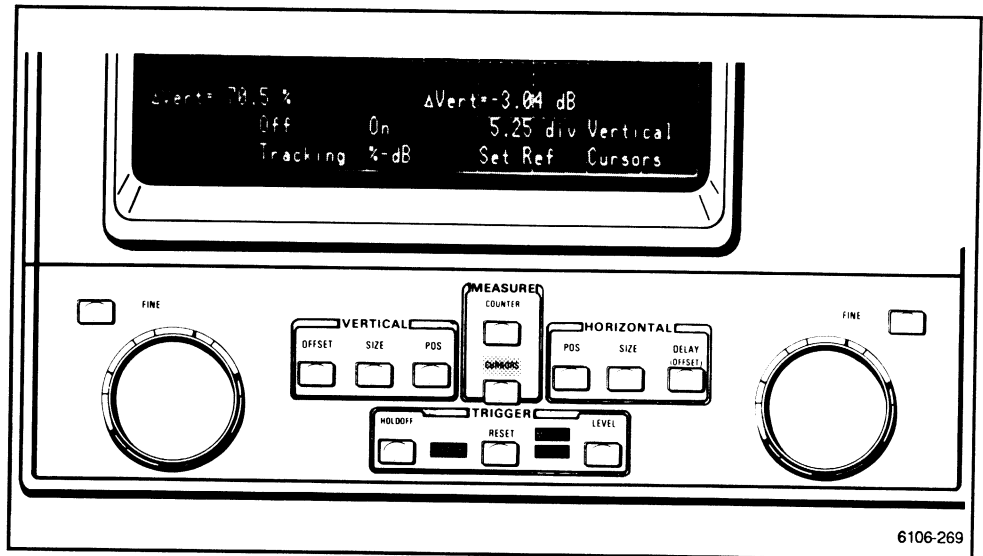

Figure 2-72. The Vertical CURSORS menu with % dB set to On yielding delta readings in percent and dB.

For the horizontal cursors on YT traces, the alternate scaling is percent and degrees (see Fig. 2-73). Delta readings of percent and degree are computed relative to the delta established when *Set Ref* is touched.

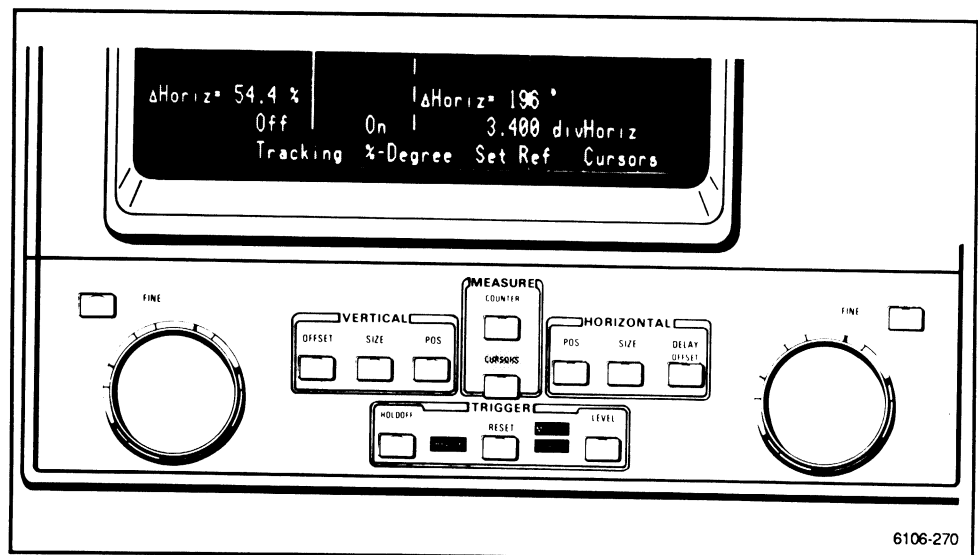

Figure 2-73. The Horizontal CURSORS menu for a YT trace with % Degree set to On.

Knob Behavior

When another knob assignment is made, the cursor readout is removed from the display, and the cursor lines remain.

Each knob assignment has its own coarse/fine function status. The oscilloscope remembers and reinstates the coarse/fine condition for any given knob assignment. Selecting coarse after making a fine adjustment does not change the value of the setting. The value can be changed only by turning the knob.

Horizontal Cursors

- Valid coarse settings are linear increments of 0.05 division.
- Valid fine settings are linear increments of 0.01 division.

NOTE

Horizontal measurement cursor length is 7 divisions starting at a 1/2 division from the bottom edge of the graticule and ending a 1/2 division from the top edge of the graticule.

Vertical measurement cursor length is 10 divisions.

Vertical Cursors

- Valid coarse settings are linear increments of 0.05 division.
- Valid fine settings are linear increments of 0.01 division.

Restrictions

- If a composite trace of conflicting sensitivities is selected, the cursors are scaled in divisions and the input offset is ignored in the cursor calculation.
- If no scaling information is available, the results are presented in divisions and the input offset is ignored.

Measure Menu

The MEASURE major menu allows you to set the oscilloscope to perform up to eight measurements. The standard measurement set consists of Frequency, Period, Width, and Duty factor plus Peak-to-Peak, Max, Mid, and Min amplitude measurements. (See Fig. 2-74.)

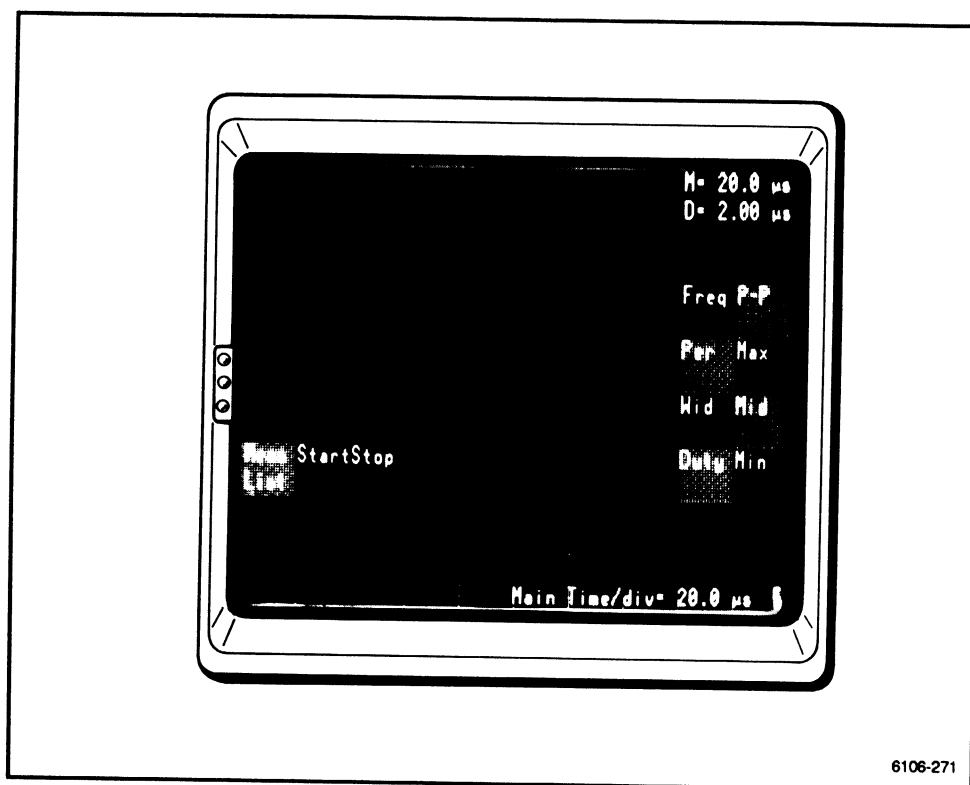

Figure 2-74. The measurement list with four choices (P-P, Per, Mid, Duty) selected.

Up to eight choices can be selected from the list. Selected measurements are shown by shading. The measurements are made once upon touching **Start**. The results will appear with time and date stamp. (See Fig. 2-75.)

The MEASURE menu has two pages: one is the list, and the other contains the results and the time and date stamp. Selecting **Meas List** displays the list showing the measurements and shading the choices you've selected. Measurement selections have alternate action. Repeatedly touching the same item once alternates it from selected to unselected.

When **Start** is touched, the select list is removed, and the measurements are made, and displayed as shown in Figure 2-75. Up to eight results can appear in the column on the right of the display. Measurements can be initiated by

touching **Start** or by pressing the probe ID button if **Probe ID** has been enabled through the UTILITY MENU. When measurements are completed, **Stop** will be shaded.

Measurements are always performed on the selected trace. If you are using the Probe ID to start the measurements, remember that the probe ID button also "selects" a trace. See the "Probe ID" in the "Waveform Acquisition" subsection for the priority of actions surrounding the ID button. If the trace consists of more than one channel for the vertical part of the trace expression, the measurements are made on the entire vertical portion. XY traces are treated similarly. Only the vertical part of the trace expression is measured.

To obtain the measurement results, the oscilloscope will have to alter many of the settings. When the measurements are completed, the oscilloscope settings are restored to their previous state.

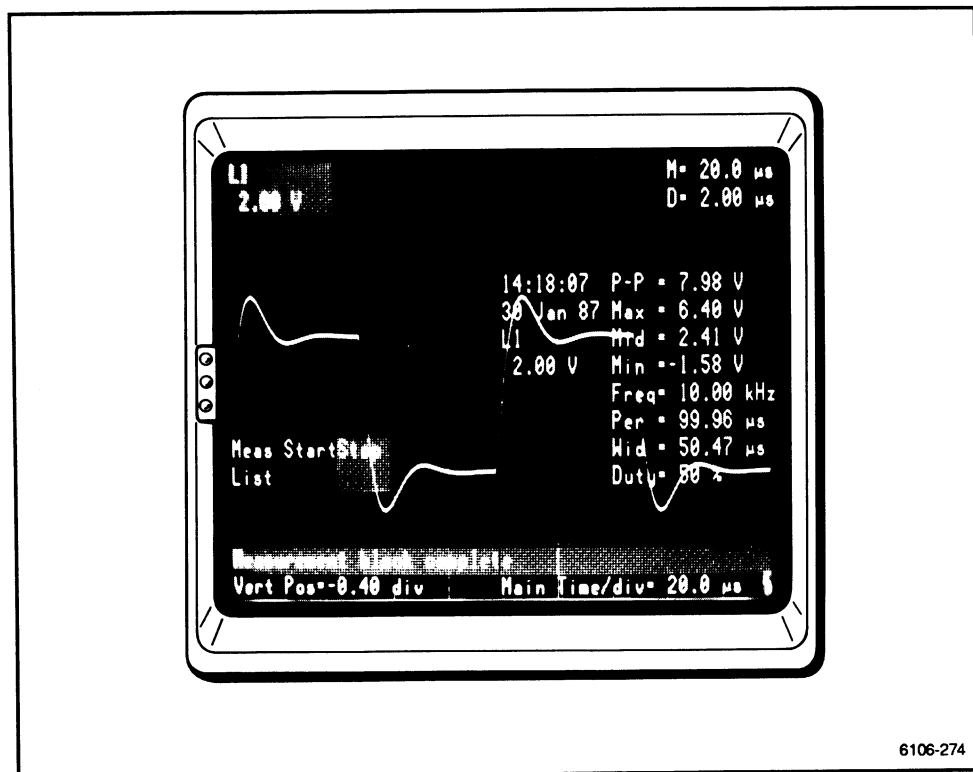

Figure 2-75. The results of eight measurements chosen from the measurement list as well as the trace measured and the time and date "stamp."

As the results displayed represent an instant in time rather than up-to-date conditions, a time and date "stamp" is displayed along with the results. The vertical expression of the trace being measured is also "stamped" and appears in the display.

There will be times, such as a loss of signal, when a measurement cannot be completed or found. If this should occur, the words "not found" appear where the numeric result usually goes. For example, if the p-p cannot be found the display shows:

"P-P = not found"

An appropriate and unique null value is available for query from the RS-232-C and GPIB interfaces. See Section 3, "GPIB and RS-232-C Interfaces."

Measurements can be aborted by touching **Stop**. If the measurements are stopped before completion, the results are treated as if they were "not found"; then **Stop** is also shaded. If **Stop** is touched when no measurements are being made, the last measured results are displayed and **Stop** is shaded.

Numeric Entry

The NUMERIC ENTRY menu provides the means to directly enter a value for:

- Changing a setting in lieu of using the knob
- Specifying a reference value for difference (delta) measurements when using the Counter/Timer
- Computing simple algebraic expressions as with a common calculator.

To engage in one of the above activities, the item of interest on the left side of the menu defines the target of the numeric operation.

In general, the name (e.g., Main Time/div) and status of the target is displayed in an area apart from the usual locations where status is shown. In this way, the actual status or setting can be viewed while constructing a new value to replace it.

New values or settings can be created in two distinctly different ways. One way is to modify the present setting using the +, -, *, and / operators. The other method is to begin with a new number or number followed by other operators. When a number is first touched, the present setting of the target is removed from the expression and replaced by the keyed-in value.

In other words, +, -, *, / can be used to modify and append a setting when touched first. Otherwise, a new expression is constructed.

For example, the target is L1 Size/div with a setting of 50 mV. To change this setting to be 1.5 times that value, two basic approaches can be taken. You can either modify or begin with a new number (see Figures 2-76 and 2-77).

STEP NO.	TOUCH	DISPLAY
1.		L1 Size/div= 50 E-3
2.	*	L1 Size/div= 50 E-3*
3.	1	L1 Size/div= 50 E-3*1
4.	.	L1 Size/div=50 E-3*1.
5.	5	L1 Size/div= 50 E-3*1.5
6.	Enter	L1 Size/div= 75 E-3

6106-275

Figure 2-76. The numeric entry modify approach.

STEP NO.	TOUCH	DISPLAY
1.		L1 Size/div= 50 mV
2.	7	L1 Size/div= 7
3.	5	L1 Size/div= 75
4.	EEX	L1 Size/div= 75E
5.	CHS	L1 Size/div= 75E-
6.	3	L1 Size/div= 75E-3
7.	Enter	L1 Size/div=75 mV

6106-276

Figure 2-77. The numeric entry new number approach.

Of course, an expression using +, -, *, and / can also be created to produce the desired value.

Entries can be completed and attempted as new settings only when **Enter** is touched. If the menu is exited before the entry is completed, the partial entry is abandoned.

All oscilloscope functions, except for major menus, do not interfere with the entry value. However, whether an entry is accepted depends on the present knob assignment.

All entries are assumed to be expressed in the same dimensions as indicated by the target. For example, an entry to change the Time/div is assumed to be in seconds. Cursor positioning is not accessible from the Numeric Entry menu. Trigger LEVEL for Main and Delayed triggers is always entered as division from the Numeric Entry menu.

In the case of the Counter/Timer, the entry can be used only to set a reference value. The entry cannot replace the measured result. There are two ways to specify the reference for the Counter/Timer. The precise number can be entered directly, as with a calculator, or the present measurement result can be used. The latter is referred to as "nulling." See "Count Reference" in this subsection.

A value between two valid settings is rounded to the nearest valid setting. For example, if 2.7231E-3 is attempted for Time/div, the oscilloscope sets the Time/div to 2.72 ms.

If the keyed-in value exceeds the maximum or minimum limits of the setting, an appropriate message is displayed in the prompt line. In general, all of the mainframe settings attempt to go to the nearest valid setting. Plug-ins may also do this but not in all cases. There will likely be cases where the setting will not be changed. This is evident by an error message.

Choices of Left or Right Knob

The left knob or the right knob allows an entry to be directed to change an instrument setting. Either of the present knob assignments can be affected by the entry.

Further indication of where the entry goes is given by shading the setting and its name. This is either the left half of the knob line or the right half of the knob setting line.

To complete an entry into the desired location, the location must be chosen before touching **Enter**. The number must be "keyed" in after the location is selected. The keyed-in numbers appear in the menu area. In this way, the actual setting is always visible in the knob line while you build and view the new setting. Figure 2-78 shows the Numeric Entry menu with an entry in progress and with its target shaded with the present setting. When the menu is exited, the shading of the target is removed.

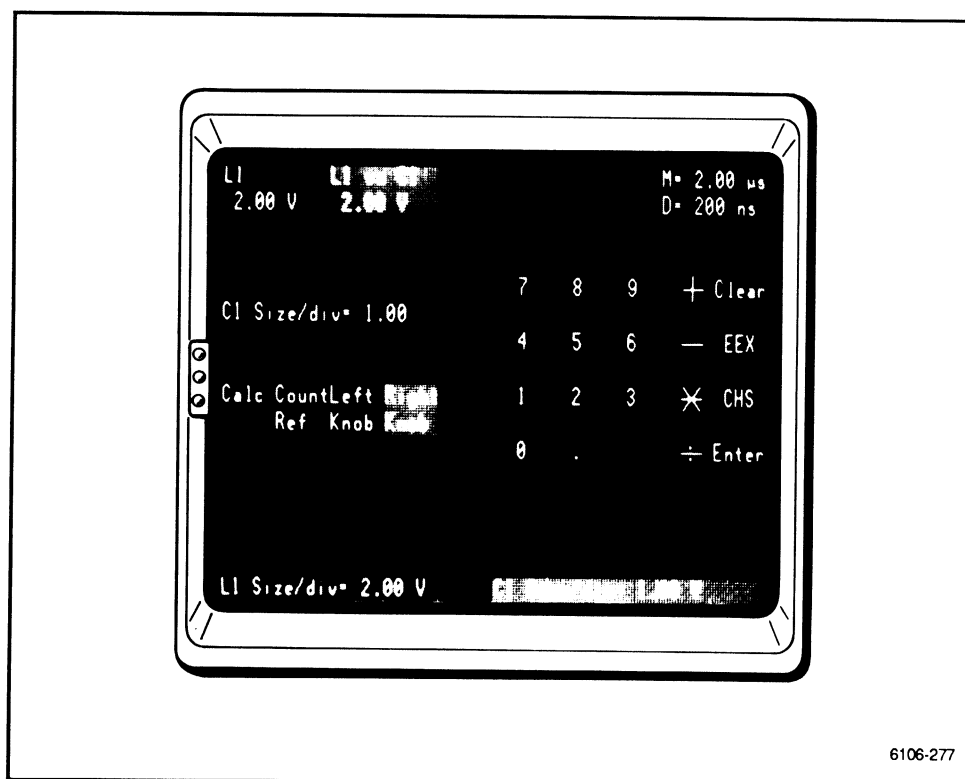

Figure 2-78. The NUMERIC ENTRY major menu.

Count Reference

Most of the measurements of the Counter/Timer can be displayed relative to something other than zero. For example, a frequency measurement can be displayed as the difference between the measured frequency and the reference. In this way, quick comparisons can be made as the display shows a deviation from the reference. When the Counter/Timer is off (not running), there is no measurement reference. When this occurs, a warning is displayed explaining that the Counter/Timer must be in use to specify a measurement reference.

When **Null** on the Numeric keypad is touched, the present values for the measurement displayed is saved and subtracted (nulled) from all following measurements of that particular type. When **Clear** and **ENTER** on the Numeric keypad menu are touched, the reference is zero and the results are displayed again as "absolutes." In addition, any valid number entered from the Numeric keypad menu is interpreted as a new reference value and displayed in the readout.

Functioning as a Calculator

As a calculator, this menu offers the convenience of performing simple operations. It does not affect any oscilloscope settings or displays other than the area displaying the calculations. Results are limited to exponents of $E \pm 15$.

Operation

When the menu is displayed, the present value of the prospective target is displayed above the four choices on the left. To change the value, the following operations apply:

- An expression can be constructed by appending to the present value. Touching **+**, **-**, *****, or **+** preserves the present value for use in a new expression. In this way, a setting could be changed by a multiple or offset by a constant. The **+**, **-**, *****, and **+** operators are interchangeable. For example, the **+** can be changed to a **-** or ***** so long as it is the latest addition to the expression.
- To eliminate the existing value from the expression, touch any number, the decimal point (**.**), or **Clear**. At this point, any expression can be constructed from the number pad and the **+**, **-**, *****, and **+** operators.
- Exponentiation (in powers of ten) of up to two digits is realized by touching **EEX**. When touched, the displayed expression will show "E+00." The two digits can be overwritten any number of times. For example, if E+76 for E+07 was mistakenly keyed-in, instead of clearing the entire expression, "0" then "7" may be touched. The new digits push out the old ones until another operator (**+**, **-**, *****, **+**) or **Enter** is touched, or the menu exited.

- **CHS** (CHange Sign) allows for sign reversal of + and -. CHS affects the first + or - found nearest to the right end of the expression. For example, when building the number "-25E-06," the leading minus can be changed before **EEX** is touched. Once touched, the expression grows from -25 to -25E+00. The sign of the exponent changes when **CHS** is touched as this is the farthest right - in the expression.

When satisfied with the new settings, the numeric entry pad can be removed by pressing the NUMERIC ENTRY Major Menu button again or by pressing any other major menu button. The shaded area, used to indicate target for the entry, also is removed.

Initial Conditions

The Keypad is assigned to the same function as it was prior to power Off.

Store and Recall (Instrument Settings)

Menu Behavior

The storing and recalling of instrument settings is intended to allow you to quickly set the instrument without the need to adjust knobs and make numerous menu selections. It is assumed that you set the oscilloscope to the desired settings and simply store the entire configuration for recalling later. Other major menus cannot be viewed while the Stored Settings menu is displayed.

One popular use permits different users, sharing the same instrument, to store setup conditions. Storing and recalling setups allows each user to have some variations without the burden of untangling settings left by someone else. In this case, the **Store** and **Recall** can serve to restore the instrument to a predefined state. However, remember if the oscilloscope is powered off, all settings, except the current one, will be lost.

The other more popular use is for a single user who wishes to cycle or sequence through many setups and repeat the sequence many times. This is an extremely valuable requirement when characterizing the behavior of a device or circuit over a wide range of conditions. In such a case, it is assumed again that the user is able to configure setups and store them in the required order. Rather than randomly recalling or deliberately choosing the next setup by its number in the sequence, the user only has to request the **Next** item in the sequence without consciously looking for the correct one. In short, the oscilloscope automatically selects the "next" setup as often as requested.

Two schemes have been devised to deal with sequential operations. The first relies upon using the **Next** operator. When **Next** is touched, the digits of the next location are retrieved as if they were keyed-in directly. The second method for sequentially accessing a setting location is through the probe ID button. From any probe, the next setting in sequence can be recalled by pressing the Identify (ID) button on the probe. The probe ID button functions identically to touching **Next**. When sequencing from the ID button on the probe, only locations with stored settings will be used. Any location that has been erased is skipped when recalling from the probe. When using the probe ID button, you can only recall settings. To enable sequencing by the probe, you must access the *Probe ID* in the Utility menu. There the sequencing function can be set to **On** or **Off**.

Operation

Pressing the STORE RECALL major menu button displays a menu offering random and sequential access for storing, recalling, and erasing complete instrument setups. (See Fig 2-79).

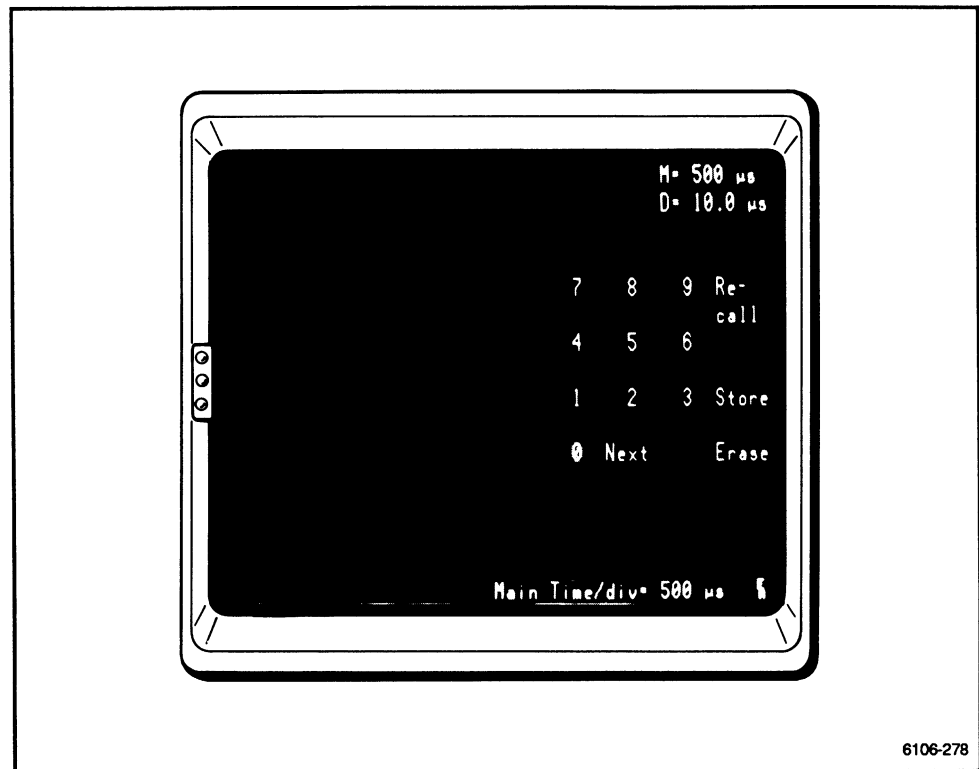

Figure 2-79. Stored settings menu selections.

To store, recall, or erase settings of a location, the desired location must be designated using the number pad followed by touching **Store**, **Recall**, or **Erase**.

As a number is entered from the menu, it is shaded to aid in identifying which location number was chosen. When you select **Store**, the Prompt/Message line displays "Storage in Buffer #X complete" (where X is a number from 0 to 9).

When you select **Recall** the message "Selected front panel setting #X recalled" (where X is a number from 0 to 9) is displayed in the Prompt/Message line (see Figure 2-80).

When **Erase** is touched, you get the message "Setting buffer erased".

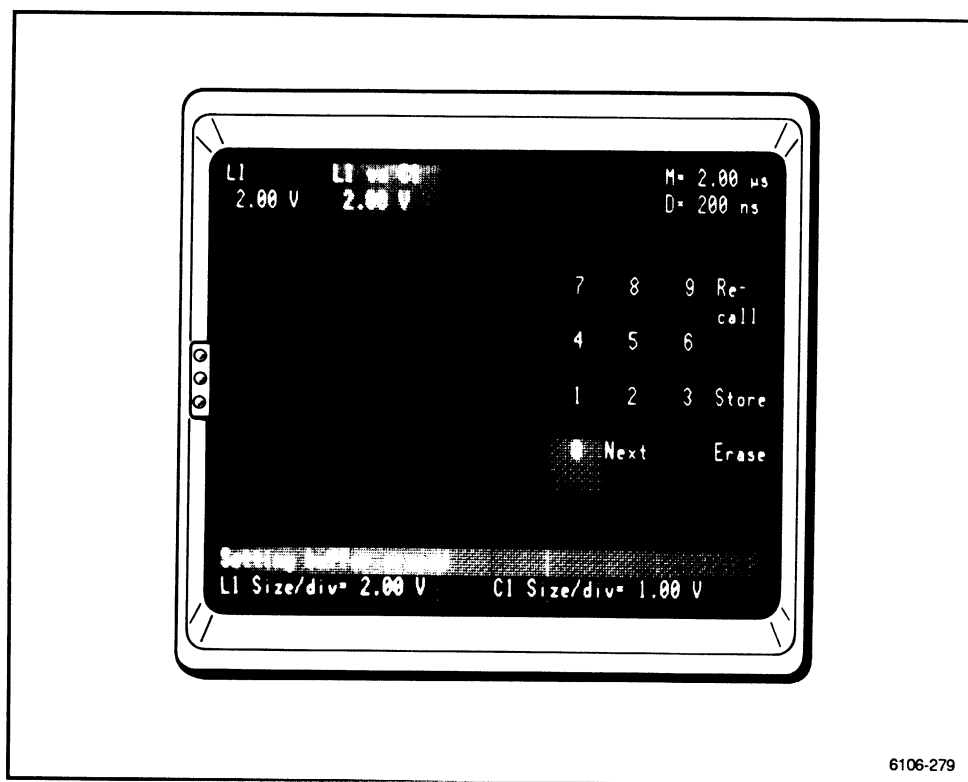

Figure 2-80. STORE/RECALL menu illustrating the Prompt/Message line.

If nothing has been stored in the location recalled, the configuration of the oscilloscope will not be modified and the message "Stored setting in buffer #X is empty" will be displayed. (X is a number from 0 to 9).

Operator's Procedure

1. Touch the desired location number.
2. Touch **Store** to record the present configuration, touch **Recall** to retrieve the desired configuration, or touch **Erase** to delete a previously stored configuration.

Utilities

The UTILITY major menu offers many selections for controlling useful but seldom accessed features. The display is divided into two sections showing all of the possible utilities on the left and specific choices for each utility, as they are selected, on the right. The selected utility is highlighted by background shading. As each utility name is touched, the functions, features, and status are displayed. The following utilities are available from this menu:

- **Autoset**—permits the selection of criteria used for searching and displaying Autoset signals.
- **Beep**—permits selection of two different loudness levels and off for the beeper.
- **Cal**—gives access to the conditions governing Enhanced Accuracy initiations.
- **Cal Sig**—allows you to specify front-panel calibrator signal characteristics.
- **Ext Test**—accesses the Extended Test menu. This is intended for qualified service personnel only.
- **GPIB**—permits selection of various parameters that control communication through the IEEE-488 computer interface.
- **Init**—configures the oscilloscope to a factory defined state.
- **I/O BNC**—permits definition of one (or more) general purpose input/output bnc connections.
- **Probe Cal**—permits correction of gain and offset errors from the probes.
- **Probe ID**—shows the status of all possible probe ID initiated functions. This also allows its assignments to be modified.
- **Probe Skew**—allows for aligning displayed traces to compensate for small variations in propagation delay.
- **RS232**—permits selection of various parameters that control communication through the RS-232-C computer interface.
- **Test**—allows access to diagnostic features.
- **Time and Date**—sets the clock and calendar of the oscilloscope display.

Autoset

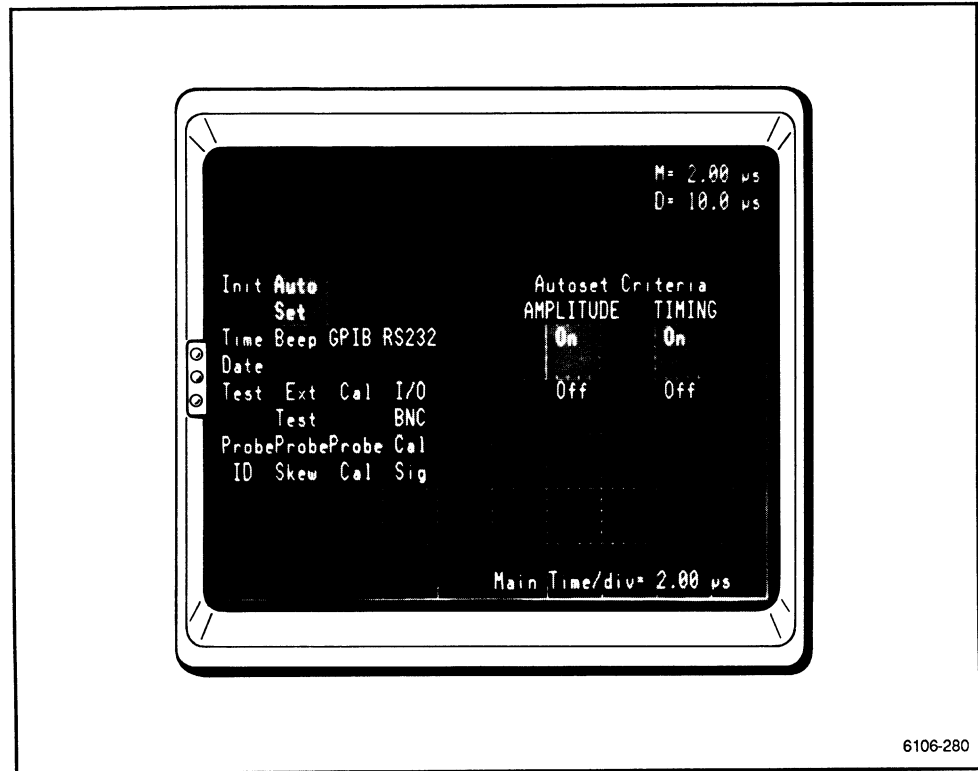

Figure 2-81. Autoset menu.

Autoset criteria can be selected for the main time base and the amplitude characteristics of the channels involved. (See Fig. 2-81.) When *TIMING* is set to **Off**, none of the time bases (main or delayed) will be adjusted. Likewise, when *AMPLITUDE* is set to **Off**, none of the input sensitivities, offset, coupling, etc. will be adjusted.

Beep

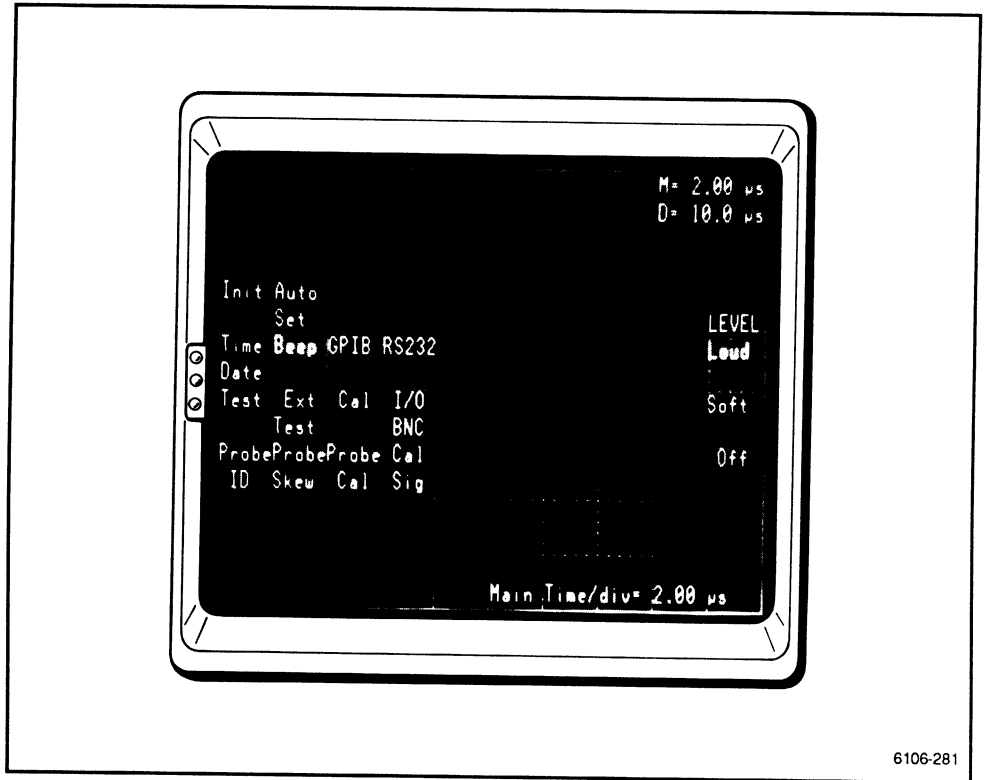
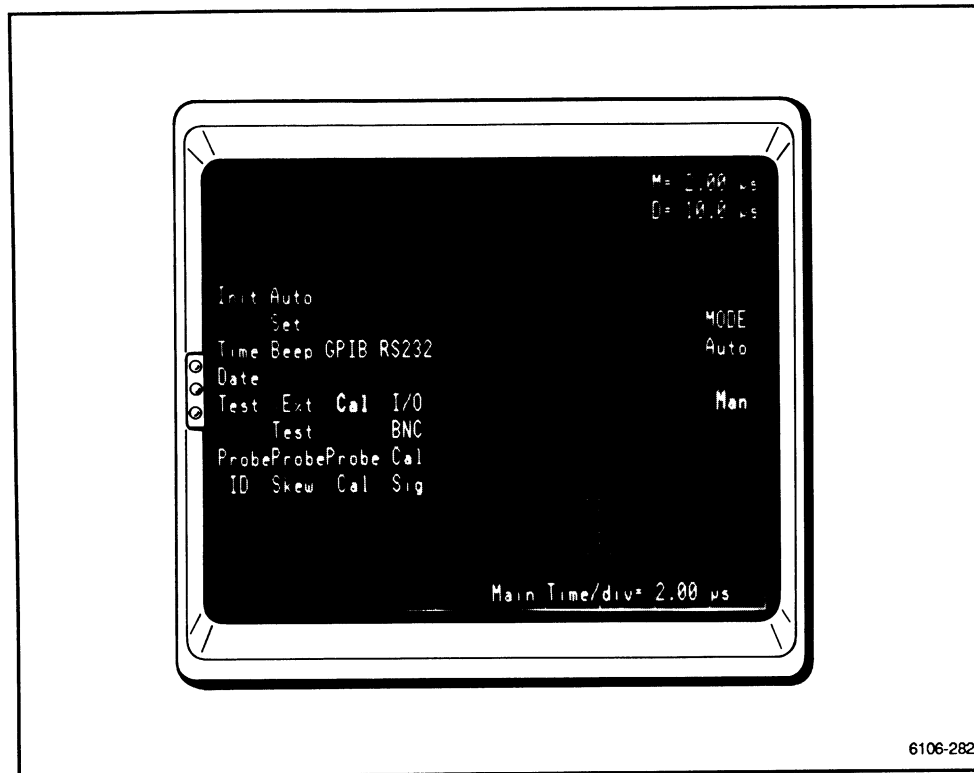

Figure 2-82. Beep menu.

The audible tone accompanying all touches and button presses can be set for **Loud**, **Soft**, or **Off**. (See Fig. 2-82.)

Calibration



6106-282

Figure 2-83. Cal menu.

The Calibration (Cal) Utility allows you to enable or disable the Enhanced Accuracy (automatic calibration) feature. The calibration feature of the oscilloscope can operate in one of two modes: Automatic or Manual (see Fig. 2-83). If **Auto** is selected, a complete self-calibration is performed when the factory preset temperature limit is exceeded. As this calibration process can disturb and interrupt the measurement process, a manual mode is provided to disable the automatic calibration.

If set for **Manual**, you must press the ENHANCED ACCURACY button, located above the crt, to initiate the process. When the temperature limit has been exceeded, a message is displayed alerting you that calibration is due.

When you manually invoke Enhanced Accuracy (EA) a message of "Self calibration completed successfully" or, if a failure occurs, a message explaining the failures goes to the originator of the command. (See also Section 3, "GPIB and RS-232-C Interfaces.")

Calibrator Signal (Front-Panel Output)

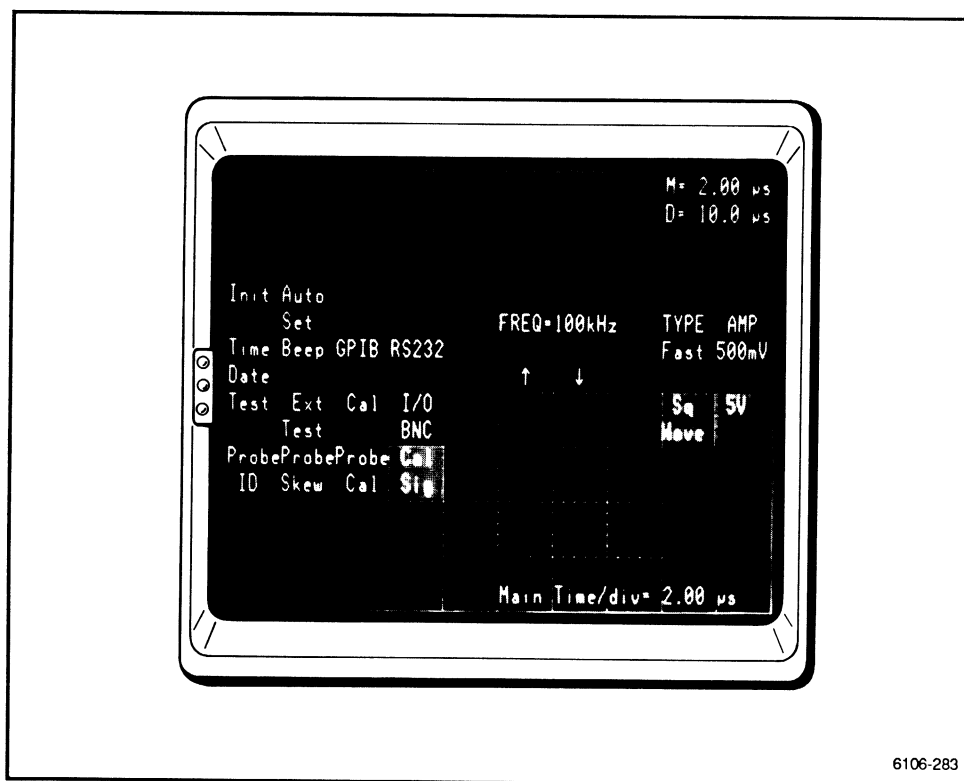

Figure 2-84. Calibrator Signal menu.

The calibration signal, which is available on the front panel of the oscilloscope, can have various amplitudes, repetition rates (frequency), and edge speeds (washes). (See Fig 2-84.) The choices available:

Signal Type:	Fast or Square Wave
Amplitude:	5 V or 500 mV
Frequency (Rep Rate):	100 Hz, 1 kHz, 10 kHz, 100k Hz, or 1 MHz

If **Fast** is selected, the amplitude is forced to 500 mV and 5V cannot be selected; **5V** is dimmed. If **Sq Wave** is selected, the maximum frequency is 100 kHz.

Extended Test

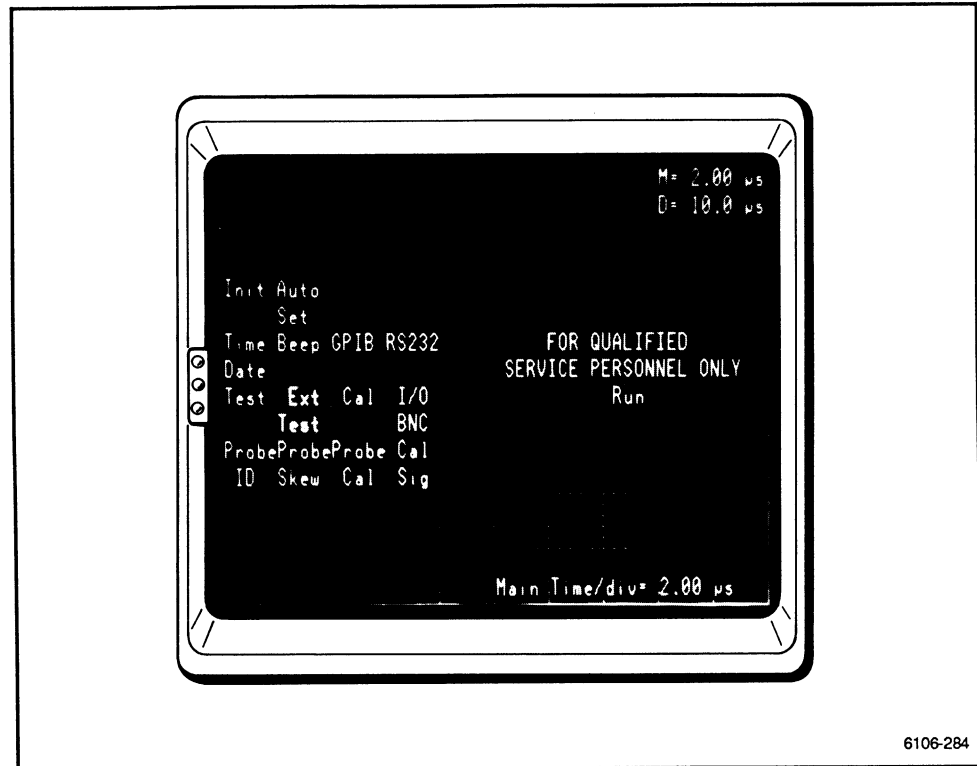

Figure 2-85. Extended Test menu.

Extended Test and diagnostics are intended for qualified service personnel only (see Fig. 2-85).

GPIB (IEEE-488)

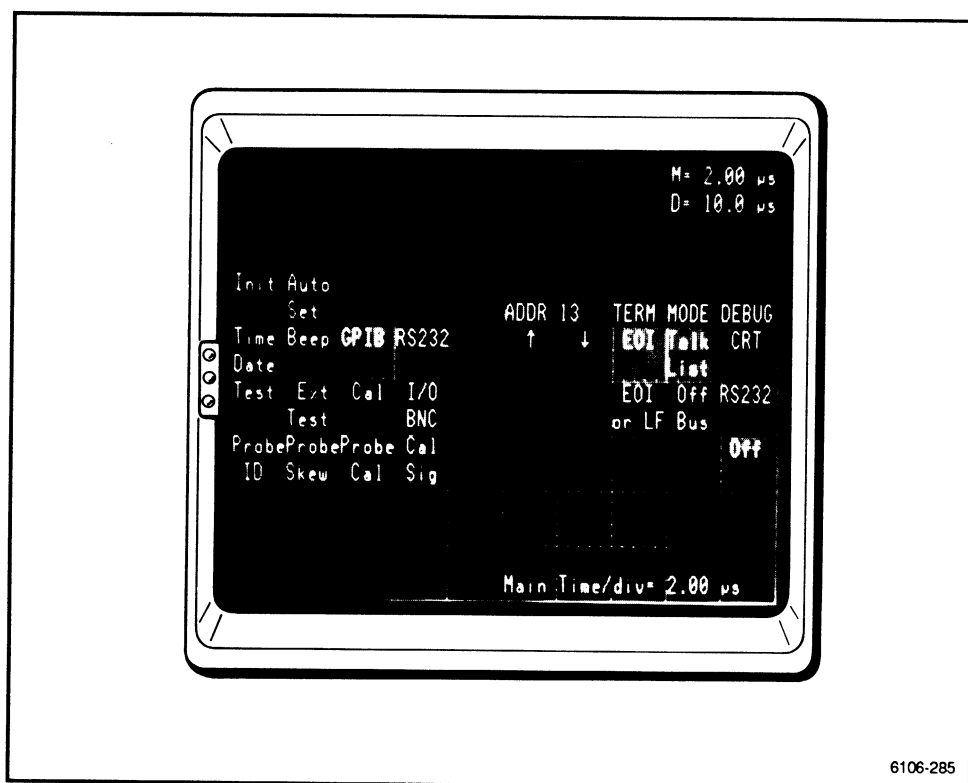

Figure 2-86. GPIB menu.

The GPIB Utility offers selection of Address (up/down), message terminator, Debug, and communication Mode. (See Fig. 2-86.)

GPIB configuration selections:

Address:	1 through 31
Message terminator:	EOI only, or EOI or LF (linefeed character)
Information destination of debugger:	Crt of oscilloscope, RS232, or Off
Mode of communication:	Talk/Listen and Off Bus

For more information see Section 3, "GPIB and RS-232-C Interfaces".

Address selection is made by touching either increment (\uparrow), or decrement (\downarrow). The value for the address can "rollover" when decremented below one or incremented above 31. These controls do not slew: only one incremental or decremental step is made at each touch.

The message terminator is used to indicate the end of a transmitted message. It is required when a message is sent to or from the oscilloscope. The terminator, EOI, is a special control line defined by the IEEE-488 standard. However, to accommodate variations by the other manufacturers of computers and controllers, the choice of terminating on receipt of a LF (linefeed) character is also provided. When *TERM=EOI* or *LF*, either will be accepted. When *TERM=EOI*, only the EOI control line can terminate the message; LF alone will not.

As an added convenience in troubleshooting GPIB transactions, *DEBUG* allows you to monitor all messages received. When errors are detected, they are trapped and flagged to alert you. Either the crt of the oscilloscope or a terminal connected to the RS-232-C port can be used to view the *DEBUG* information. This information is simply a duplicate of the message received with errors noted of syntax, semantics, and illegal or unrecognizable commands. Errors are noted by an appropriate number code inserted into the message immediately following the source of error.

If the crt is chosen as the destination for viewing the message, the message appears in the space usually allotted for major menus, the center eight lines. If the message exceeds the 400 characters (8 lines x 50 characters), the display shows the latest information by vertically scrolling as each line of new characters are received. This information can be viewed only when no major menus are displayed. However, the message is still updated while another major menu is up. When the major menu is removed, the *DEBUG* message is complete and current.

The communication mode can be set for two-way transmissions by using **Talk List** (Talk and Listen) or **Off** by setting *MODE* to **Off Bus**.

Initialize

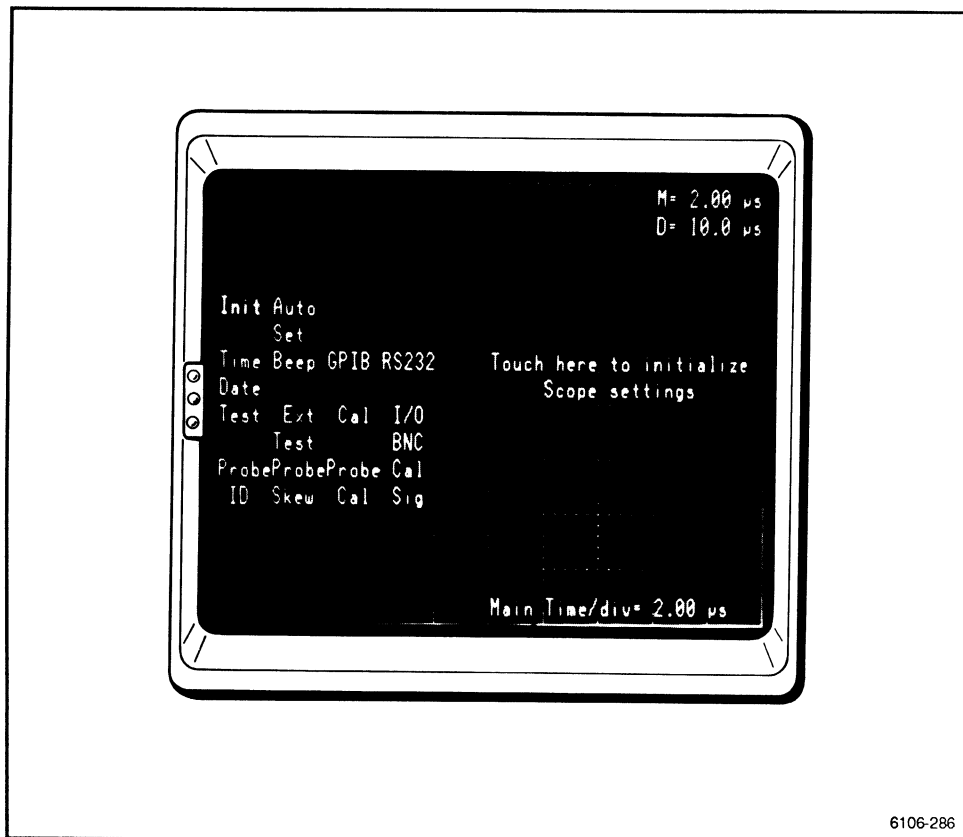

Figure 2-87. Initialize menu.

Touching *Init* (see Fig 2-87) allows initialization of the oscilloscope to the conditions listed in "Oscilloscope Initialization" in the "Oscilloscope Familiarization" subsection.

Input and Output BNC Control

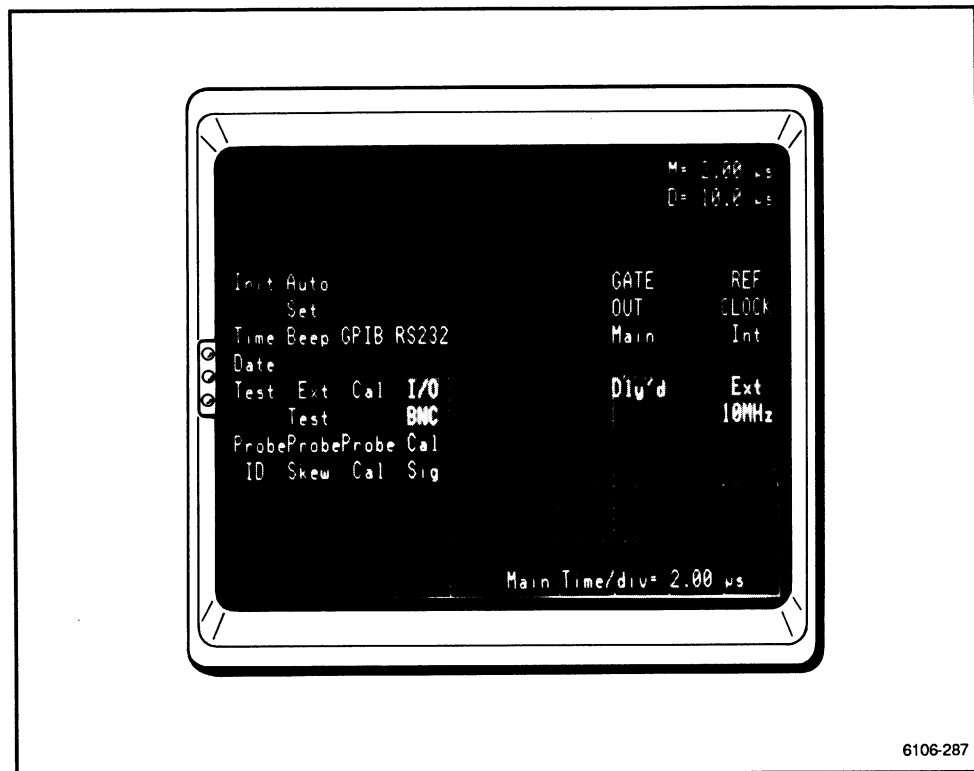

Figure 2-88. I/O BNC menu.

On the rear of the oscilloscope, two bnc connectors share four possible input or output signals. One bnc is for the Main Sweep Gate or Delayed Sweep Gate output. The other bnc is for the reference clock into or out of the Counter/Timer. When **REFCLOCK=Ext 10 MHz**, the Counter time base reference is the External signal; when **REFCLOCK=Int**, the Counter uses the internal clock and outputs its 10 MHz reference. When selecting the **Int** (internal) clock, the optional high stability (oven) time base will supersede the standard clock if it is present. The mainframe figures out whether the oven is installed and operating. (See Fig. 2-88.)

Probe Cal

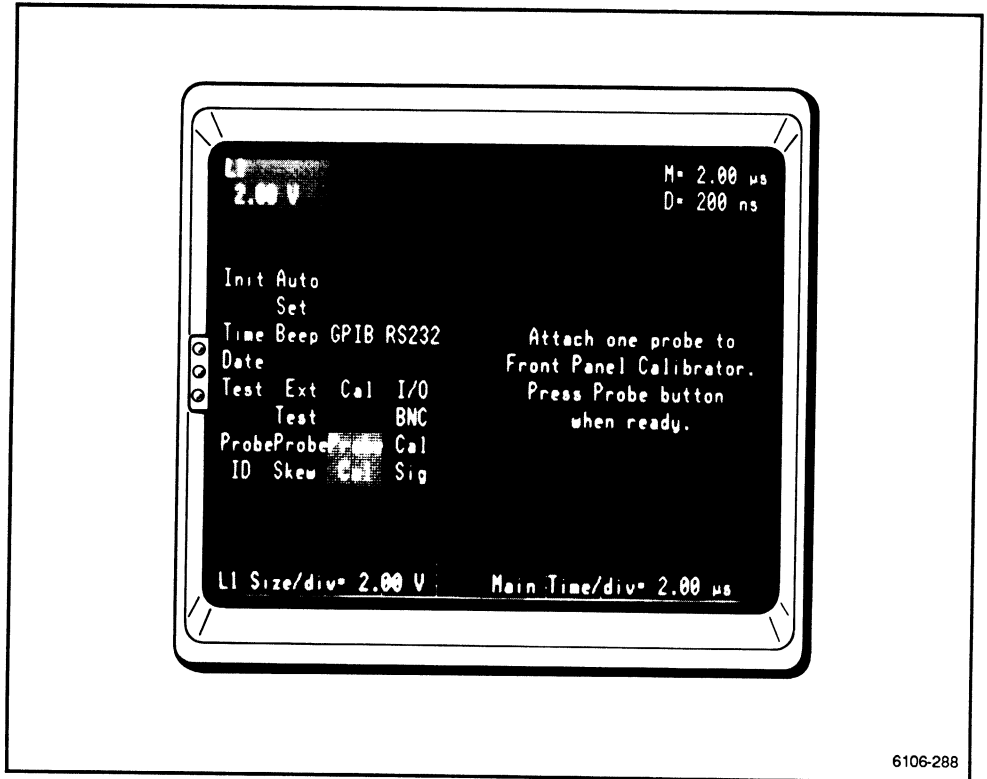
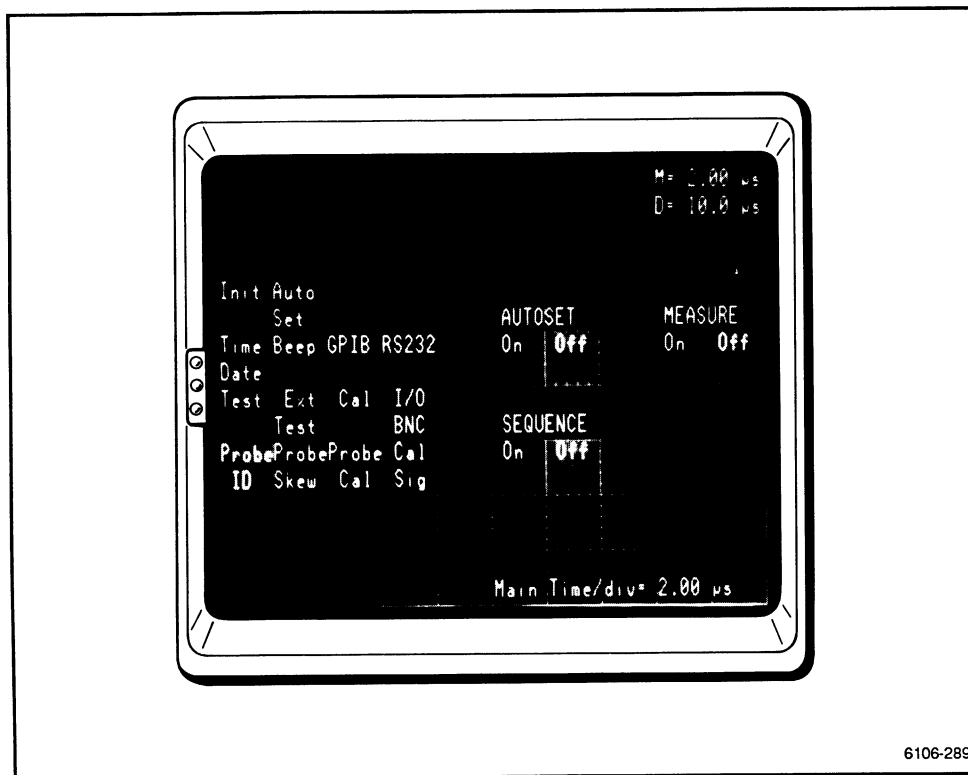

Figure 2-89. Probe Calibration menu.

When *Probe Cal* (see Fig. 2-89) is selected from the UTILITY menu, the right side of the screen displays the instructions for calibrating the dc gain and offset of the probe.

Probe ID



6106-289

Figure 2-90. Probe ID selection.

The identify (ID) button on the probe body can be assigned to initiate several operations. These operations can be programmed through the **Probe ID** menu as shown in Fig. 2-90. The probe ID button can initiate Autoset, measurements, and the sequential recall of stored instrument settings.

Probe Skew

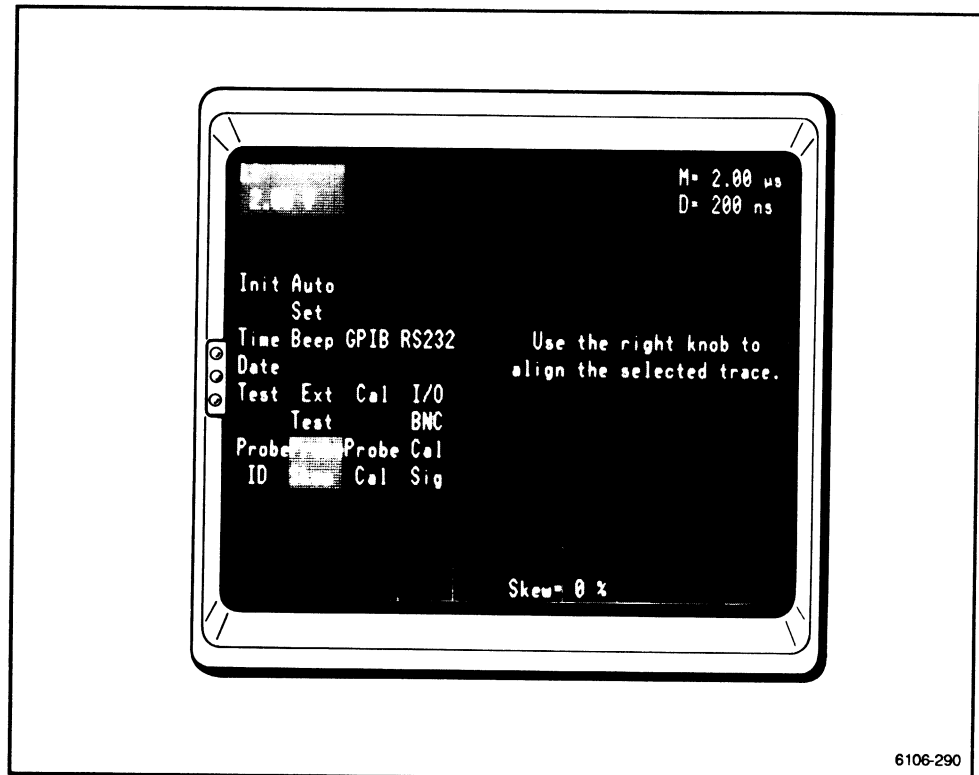

Figure 2-91. The Probe Skew menu.

When *Probe Skew* is pressed (see Fig. 2-91), you may align your probe with the selected trace to compensate for small variations in propagation delay. This adjustment allows for about 1 ns total range. This is intended for visual alignment of traces only. As this affects only the display, it has absolutely no effect on the Counter/Timer and Main and Delayed trigger functions. To compensate for timing differences in Counter/Timer measurements, see "Nulling the Counter/Timer" under "Counter/Timer Concepts" in this section.

RS-232-C Selections

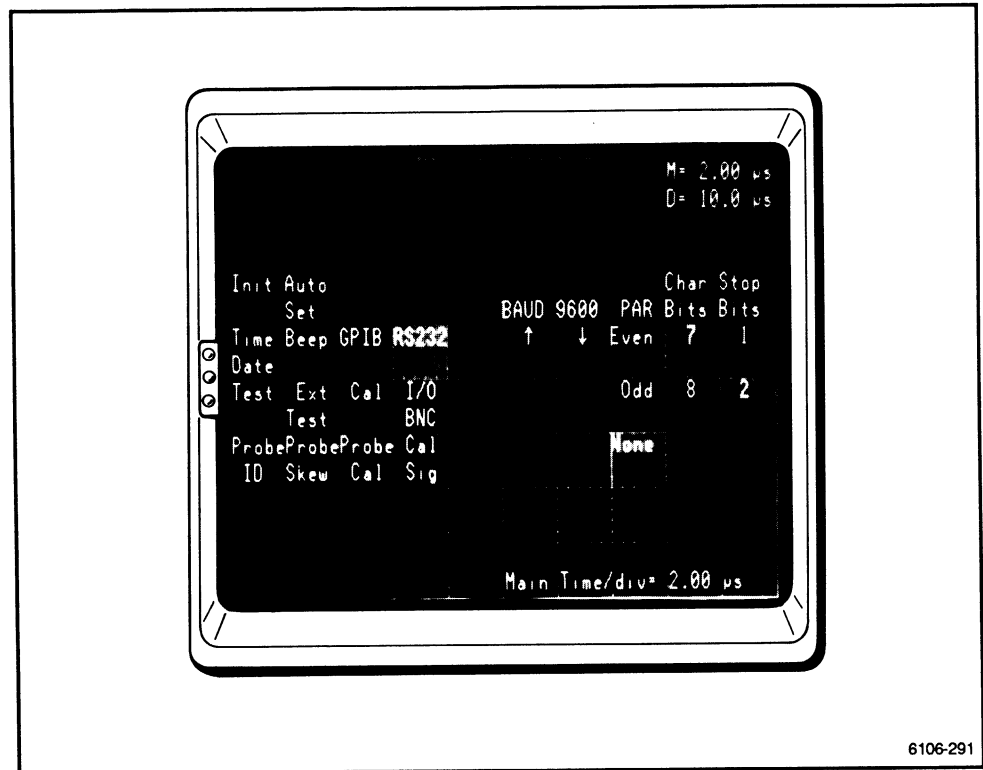

Figure 2-92. RS232 menu.

The RS232 Utility offers selections for Baud Rate (up/down), minimum Delay (up/down), Parity, and Flagging. (See Fig. 2-92.)

RS-232-C interface configuration selections:

BAUD: 110, 150, 300, 600, 1200, 2400, 4800, 9600
PARity: Odd, Even, or Off
Char Bits: 7 or 8
Stop Bits: 1 or 2

BAUD is selected by incrementing and decrementing controls. These values will "rollover." If decremented below the minimum value, the value will become the maximum. If incremented above the maximum value, the value will become the minimum.

For detail on Flagging, Parity, and Delay, see Section 3, "GPIB and RS-232-C Interfaces."

Test

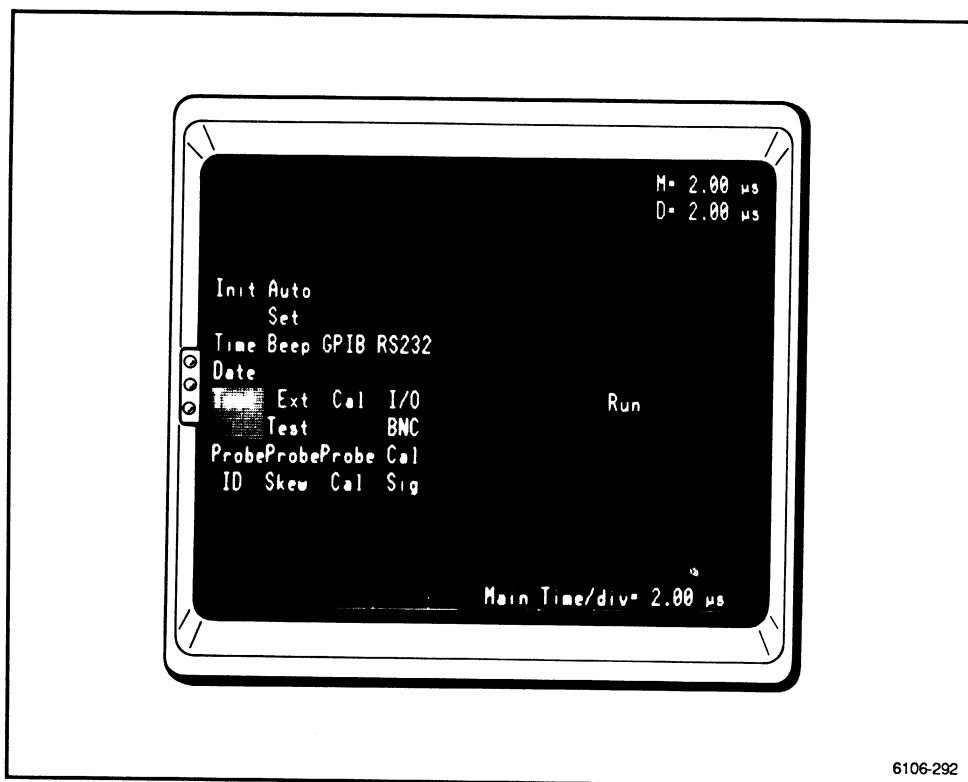

Figure 2-93. The Test menu.

To initiate self-test, the Test UTILITY menu must be selected followed by touching **Run**. (See Fig. 2-93.) This two step operation is intended to eliminate accidental activation of the self-test that may take up to 30 seconds. See more detail in "Self-Test" under "Power-Up Information" in the "Oscilloscope Familiarization" subsection.

Time and Date Selections

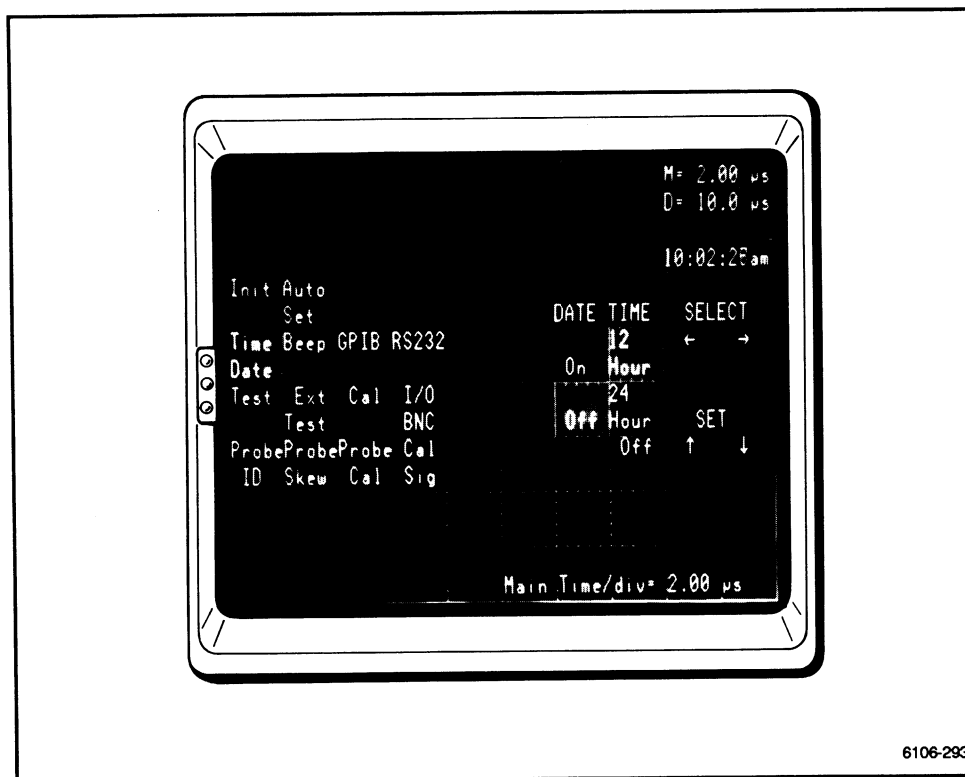

Figure 2-94. Time and Date selected from the UTILITY major menu.

In the Time and Date (calendar and clock) display, the time and date can be adjusted to the correct setting. Notice in Figure 2-94 that the time can be expressed in a 12-hour or a 24 hour format.

Upon entry into this menu, a shaded cursor, one character in width, appears over the far left digit in the *Time* display (if both Time and Date are displayed or if Time only is displayed). If Date only is displayed, then the cursor appears on the far left digit of the Date. To adjust the *TIME* or *DATE*, touch one of the *SELECT* arrows to position the cursor over the item to be modified, then use the *SET* arrows to increase or decrease the value. When satisfied, exiting the menu by touching another utility function removes the cursor from the display.

The date is expressed as dd mmm yy where dd is a two digit number for day, mmm a three character abbreviation for month, and yy a two digit number for the year (e.g., 12 Aug 88).

Measurement Concept Tutorial

The following discussion is intended to help the inexperienced user to know how, in general, to make certain kinds of typical measurements. This is not a detailed instruction; therefore, many of the steps will tell you what to do but not specifically why to do it.

Coaxial Cables and Probes

Coaxial Cables

Cables may be used to connect signals to the input connectors on the oscilloscope or plug-ins, but they may considerably effect the accuracy of a displayed waveform. To maintain the original frequency characteristics of an applied signal, use only high-quality, low-loss coaxial cables. Coaxial cables should be terminated at both ends in their characteristic impedance (e.g., 50 Ω cables should have the input impedance of the amplifier input set to 50 Ω). If this is not possible, use suitable impedance-matching devices. Coaxial connections on this instrument are bnc connectors.

Probes

Probes offer the most convenient means of connecting an input signal to the instrument. Shielded against electromagnetic interference, the standard X10 probes have a high input impedance that minimizes circuit loading. This allows the circuit under test to operate with a minimum of change from the normal, unloaded condition.

Both the probe and its accessories should be handled carefully to prevent damage. Avoid dropping the probe body. Replace the tip cover when not using the probe to protect the tip. Exercise care to prevent the cable from being crushed or kinked, and avoid pulling on the cable as this causes excess strain.

Inductance introduced by either a long signal or ground lead forms a series-resonant circuit. This circuit affects system bandwidth and causes ringing if driven by a signal containing significant frequency components at or near the resonant frequency of the series-resonant circuit. Oscillations (ringing) can appear on the oscilloscope display and distort the true signal waveform. Always keep both the ground lead and the probe signal-input connections as short as possible to maintain the best waveform fidelity.

Misadjustment of probe compensation is a common source of measurement error. Due to variations in oscilloscope input characteristics, probe compensation should be checked and adjusted, if necessary, whenever the probe is moved from one oscilloscope to another or between channels of the same oscilloscope. See "Probe Cal" in the "Utilities" subsection.

Measurement Examples

The following information describes the techniques for making basic measurements. You must remember that many, if not all, of the calculations are performed automatically by the oscilloscope and displayed in the readout. These applications are discussed to familiarize you with making a variety of measurements. Each application must be adapted to the requirements of the individual measurement. Contact your local Tektronix Field Office or representative for additional assistance.

Automatic Measurements

General waveform characteristics can be determined automatically with very little operator interaction. The MEASURE major menu allows you to perform such measurements as Peak-to-Peak (**P-P**), Maximum (**Max**), Middle (**Mid**), and Minimum (**Min**) amplitude, Frequency (**Freq**), Period (**Per**), Width (**Wid**), and Duty Factor (**Duty**). Any or all of these measurements can be chosen for display at one time.

Automatic measurements can be performed on the "Selected Trace." The procedure is the same for any measurement.

1. Press the MEASURE major menu button. (See Fig. 2-95.)

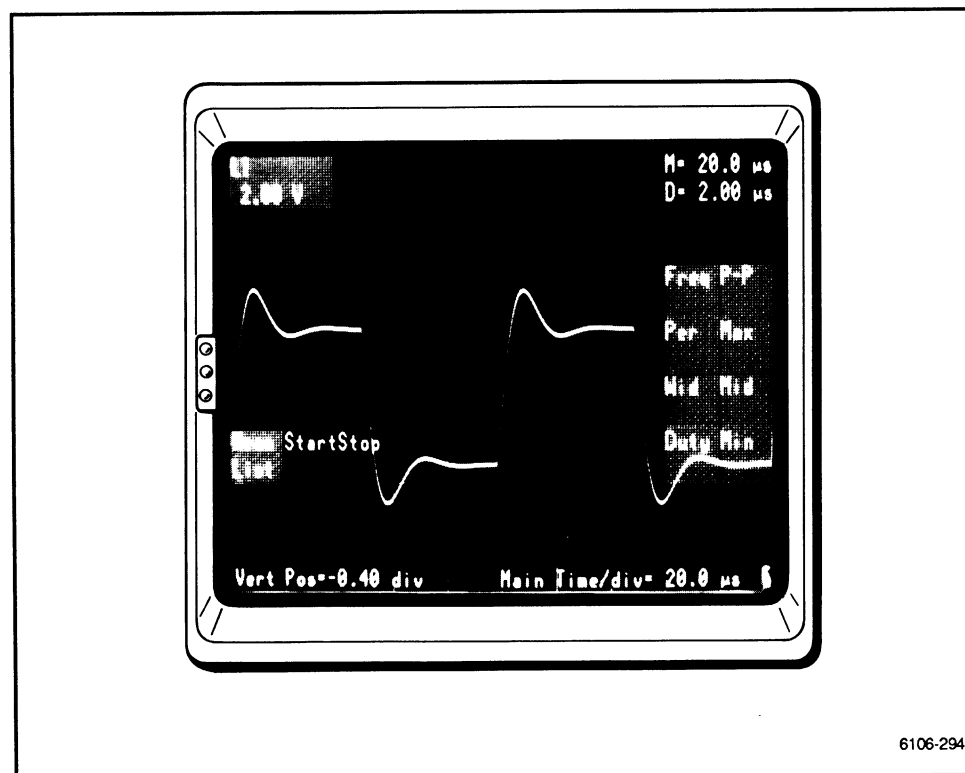

Figure 2-95. The MEASURE major menu.

2. On the screen, touch *Meas List* to display all the measurements that can be performed automatically.
3. Touch the desired measurement name (e.g., **P-P**, **Max**, **Freq**, etc.)

NOTE

At this point any or all the listed measurement items can be selected and performed simultaneously. To indicate that a measurement has been selected, it is highlighted. To eliminate a selected measurement that is highlighted, simply touch it again.

4. To begin the measuring process, touch **Start**. The results will appear on the right side of the display along with the time and date of the measurement. To get new results, touch start again. (See Fig 2-96.)

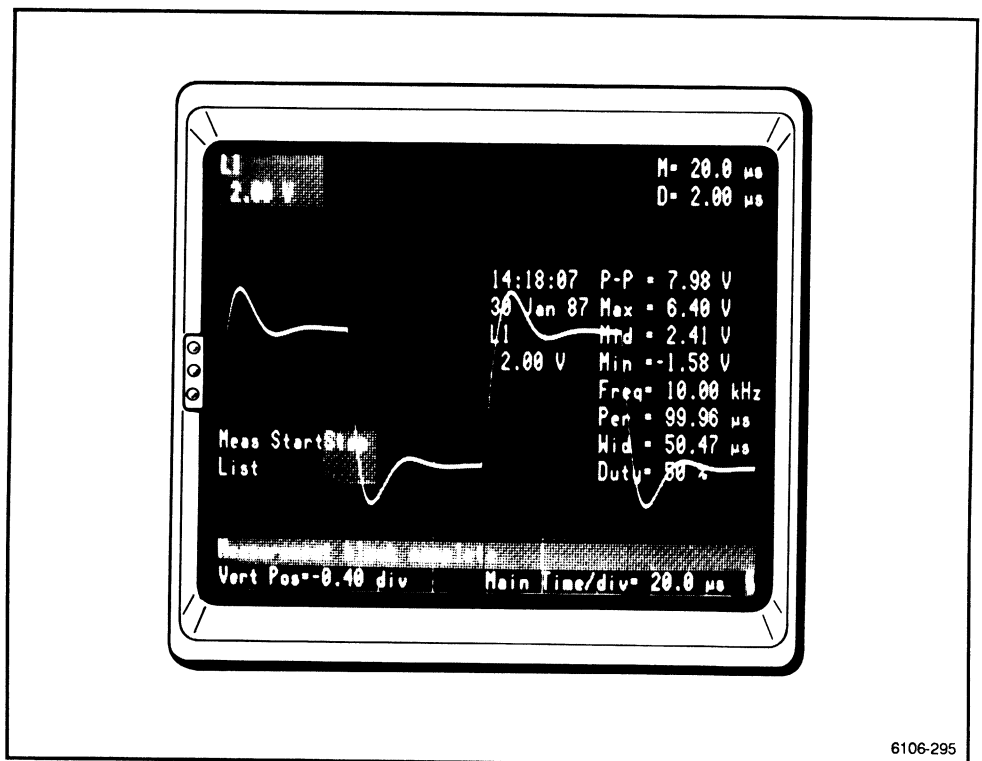

Figure 2-96. The MEASURE menu display after touching Start.

Measurements can be initiated three ways:

- By touching the **Start** label in the MEASURE menu.
- By touching a button at the tip of the probe. This must be enabled using the UTILITY menu called *Probe ID*.
- By the remote interfaces (GPIB and RS-232-C).

Cursors Measurements

The cursor feature provides you with caliper type (movable) marks on the crt screen, which you can align with any part of a waveform display to determine amplitude or time with respect to a reference point or with respect to each other.

Peak to Peak Measurements

The following procedure shows how to perform peak-to-peak amplitude measurements:

1. Connect the signal to a vertical amplifier.
2. Press the display on/off button to turn on the channel display.
3. Press the AUTOSET button to scale the vertical and horizontal and to set the triggering.
4. Press the CURSOR button and select **Vertical Cursors** from the menu. Make sure that % dB and *Tracking* are **Off**. (See Fig. 2-97.)

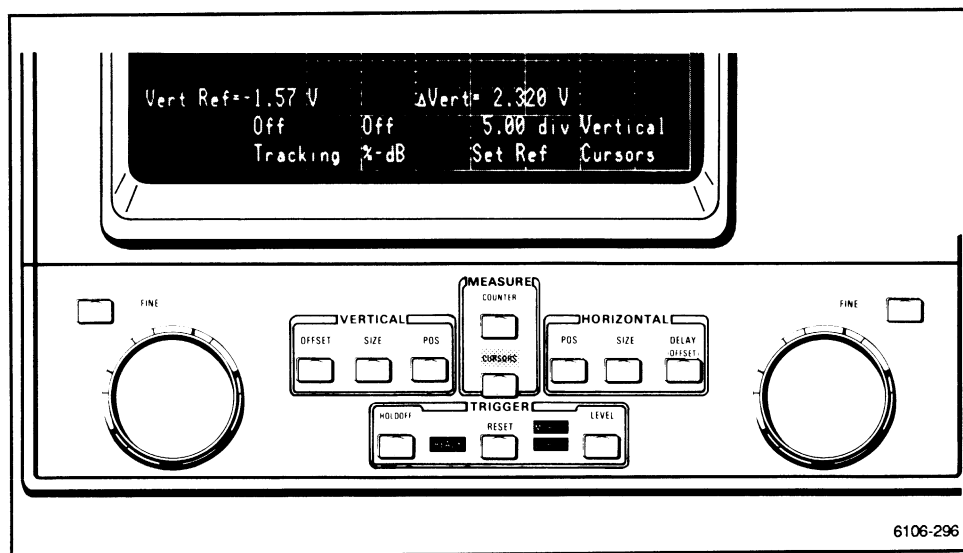

Figure 2-97. CURSORS menu after selecting vertical cursors.

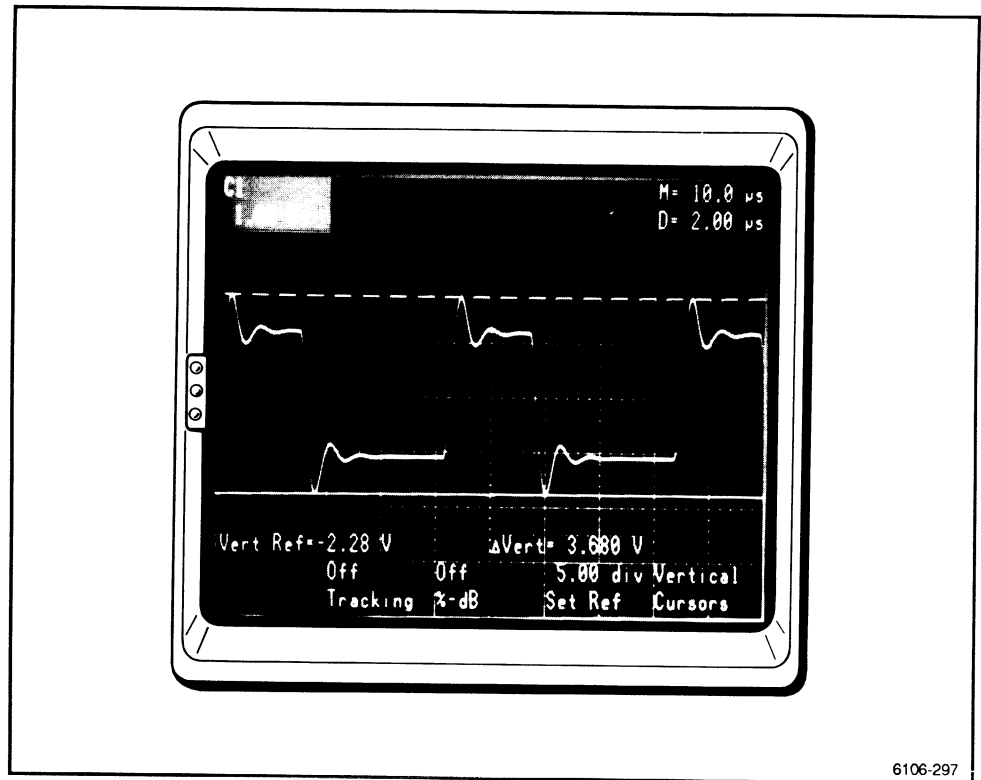

Figure 2-98. Cursors set to peaks of displayed waveform, and p-p voltage (ΔV).

5. Adjust the left knob to position one cursor at the bottom of the trace.
6. Adjust the right knob to position the other cursor line at the top of the trace.
7. The p-p voltage value will appear as ΔV toward the lower right of the crt. (See Fig. 2-98.)

Phase Measurements

The phase angle between two or more time related signals can be accurately measured using Cursors. The following procedure shows you how to set the Cursor readout to get an answer in degrees.

1. Connect the lagging signal to an input channel and set the display on/off button to on. Press the AUTOSET button, then connect the leading signal and set the display on/off button to on. Press AUTOSET again to setup the second signal. (See Fig. 2-99.)

NOTE

Use coaxial cables or probes that have a similar time-delay characteristics with insignificant delay differences to connect the signals to the input channel connectors.

2. Press the HORIZONTAL SIZE button and adjust the right knob to display at least one cycle of both waveforms.
3. Press the VERTICAL POSITION button and use the left knob to move the waveforms so that a horizontal graticule line bisects each trace.
4. Press the CURSORS button, and then select **Horizontal Cursors** and **% Degree On**.

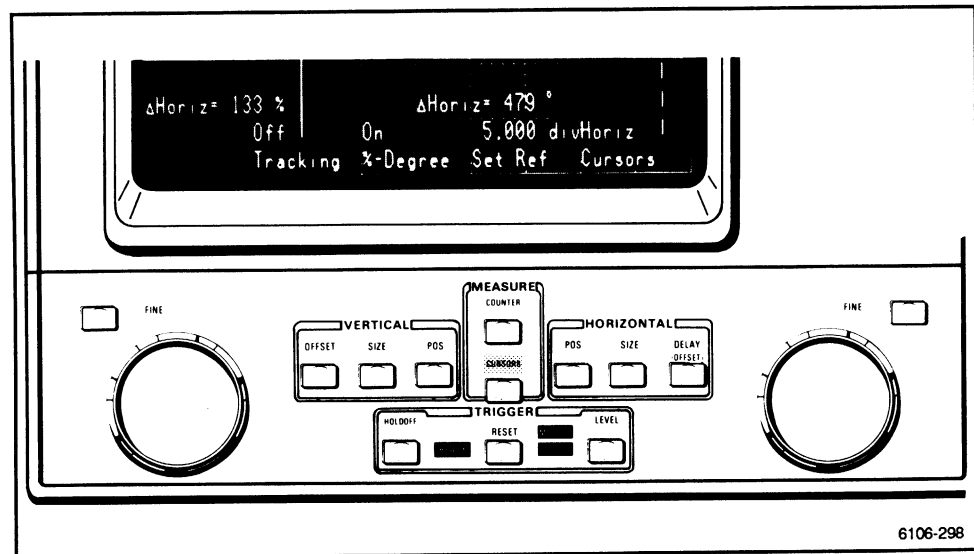

Figure 2-99. Cursor Menu with Horizontal cursors selected and % Degree set to On.

5. Adjust both Cursors to span one cycle of the leading trace. Each cursor should intersect the trace and the horizontal graticule line which bisects the trace. (See Fig. 2-100.)
6. Touch *Count Ref* in the cursor menu. This establishes the cursors displacement as 360° .

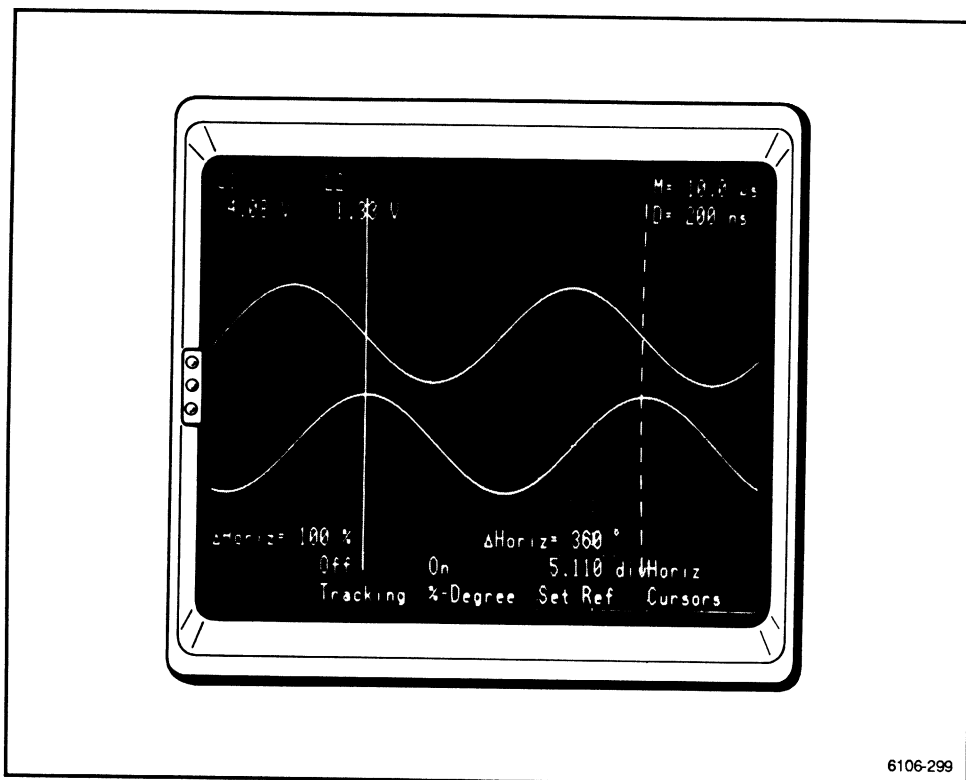

Figure 2-100. Selecting one cycle with the Horizontal Cursors.

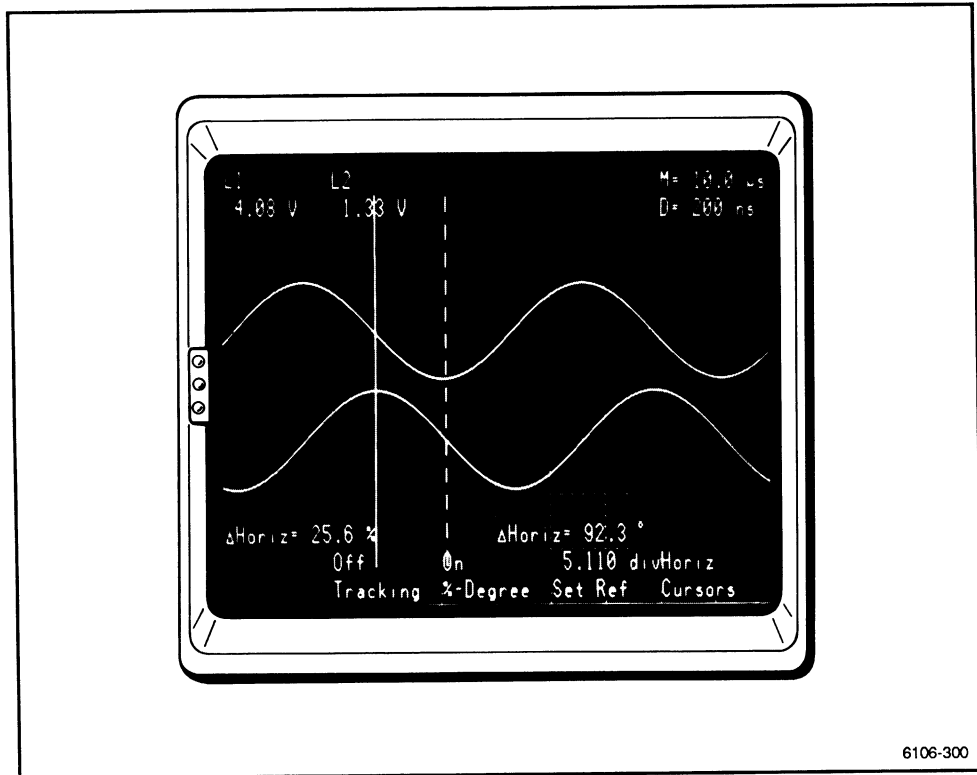

Figure 2-101 Phase angle result.

7. Position the right cursor to the first zero transition of the lagging trace that follows the position of the left cursor. (See Fig. 2-101.)
8. The phase angle answer is displayed as ΔHoriz near the lower right corner of the crt screen.

Rise Time Measurements

Rise time is the time the leading edge of a pulse takes to rise from 10% to 90% of its final value. The following procedure shows how to perform a rise time measurement using cursors.

1. Connect the signal to the input connector, set the display on/off button to on, and press the AUTOSET button. (See Fig. 2-102.)

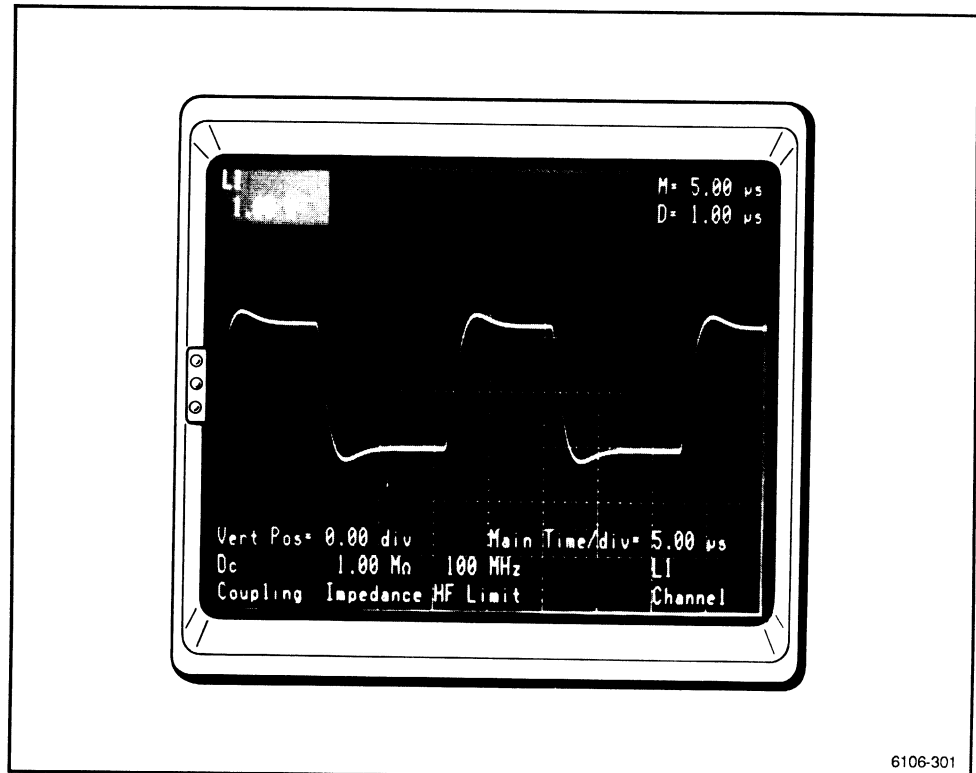

Figure 2-102. Input signal displayed.

2. Using the VERTICAL SIZE with the FINE control, adjust the trace such that the top (100% point or plateau) value and the bottom (0% point or baseline) value (not the Min or Max) are 5 divisions apart. (See Fig. 2-103.)
3. Using VERTICAL POSITION align the top and the bottom with the 0% and 100% markings on the crt screen.

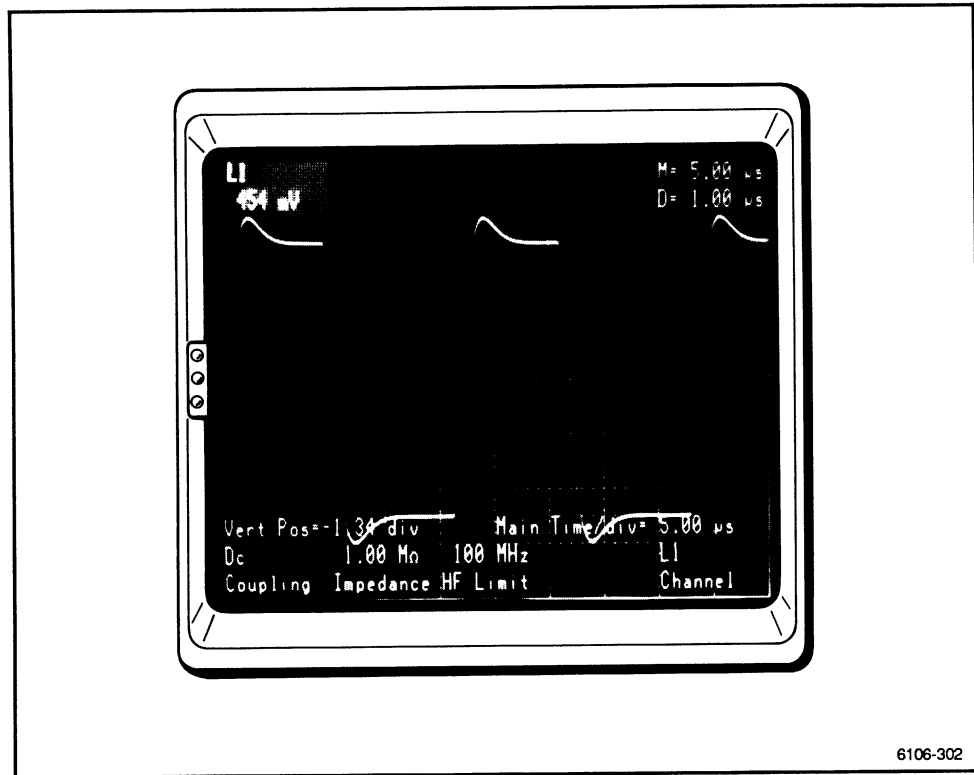

Figure 2-103. Setting VERTICAL SIZE and POSITION.

4. Press the HORIZONTAL POSITION button and align a rising edge of the signal with the center vertical graticule line. (See Fig. 2-104.)

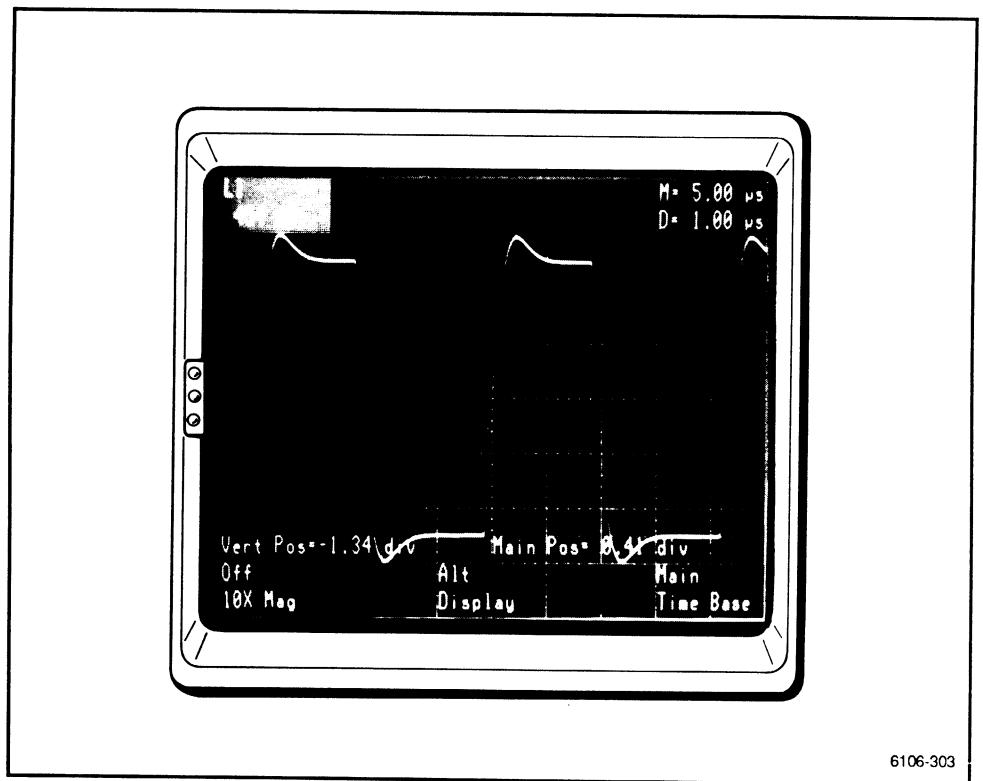

Figure 2-104. Aligning the rising edge using HORIZONTAL POSITION.

5. Touch *10X Mag* to read **On**. (See Fig. 2-105.)

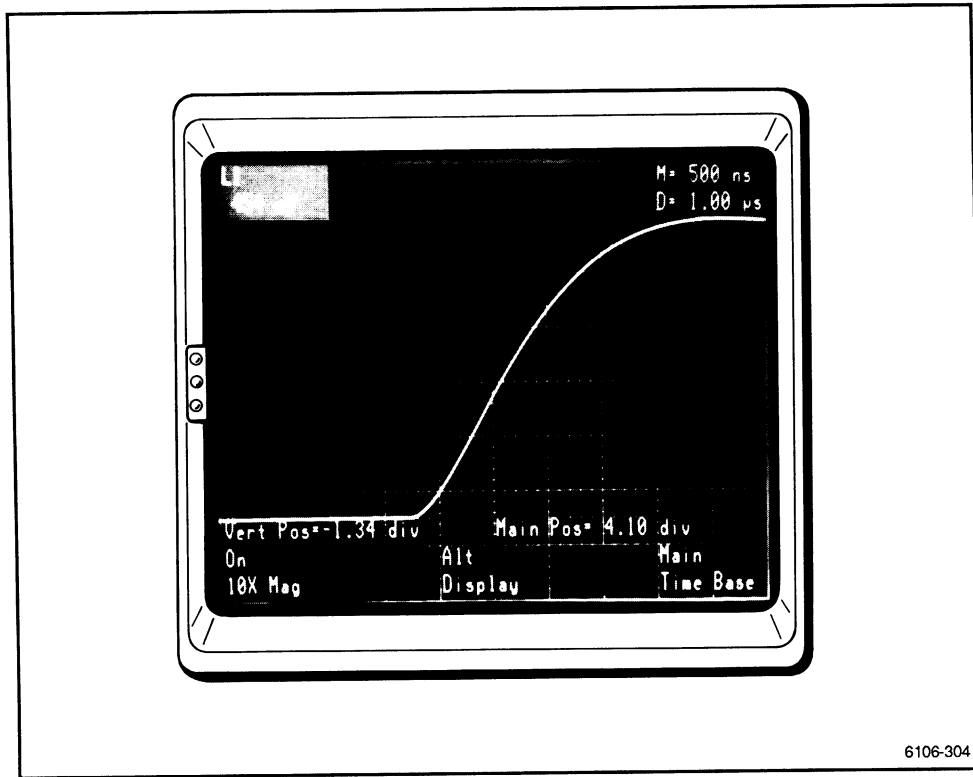

Figure 2-105. 10X Magnified signal.

6. Press the CURSORS button and select **Horizontal Cursors**. Be sure that *% Degree* is set to **Off**. Adjust the cursor lines until the left cursor intersects the trace at the 10% graticule line and the right cursor intersects the trace at the 90% graticule line. The rise time appears as ΔHoriz near the lower right corner of the crt screen. (See Fig. 2-106.)

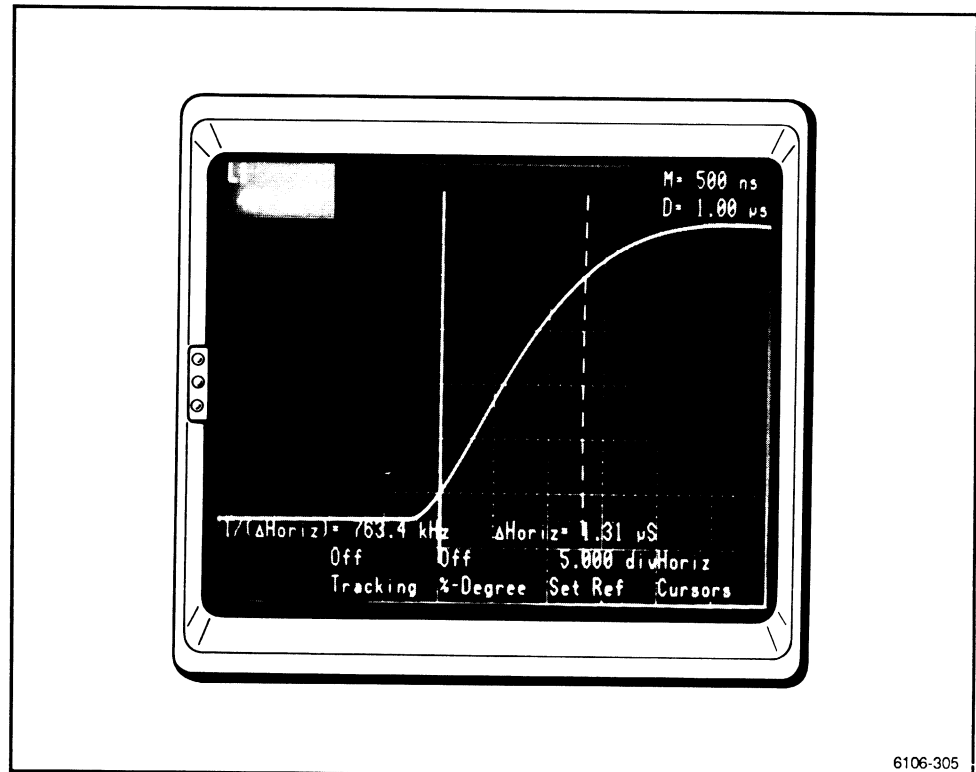

Figure 2-106. Setting the cursors to measure rise time.

Counter/Timer Measurements

The following shows step-by-step procedures on how to use various Counter/Timer features. For more information on these features see "Counter/Timer Concepts" in the "Measurement" subsection.

Basic Frequency Measurements

The following procedure shows an easy way to engage the counter to make frequency measurements. This same procedure can also be used for making *Width* and *Period* measurements.

1. Connect a cable or probe to the signal to be measured. For this example a sine or triangle wave with a frequency of 1 kHz or more will be best.
2. To display the signal, press the plug-in display on/off button, then press AUTOSET to scale the waveform and to set the triggering. As Autoset forces the trigger sources to be the same as the selected trace, there is no need to to examine the Trigger Source selections.

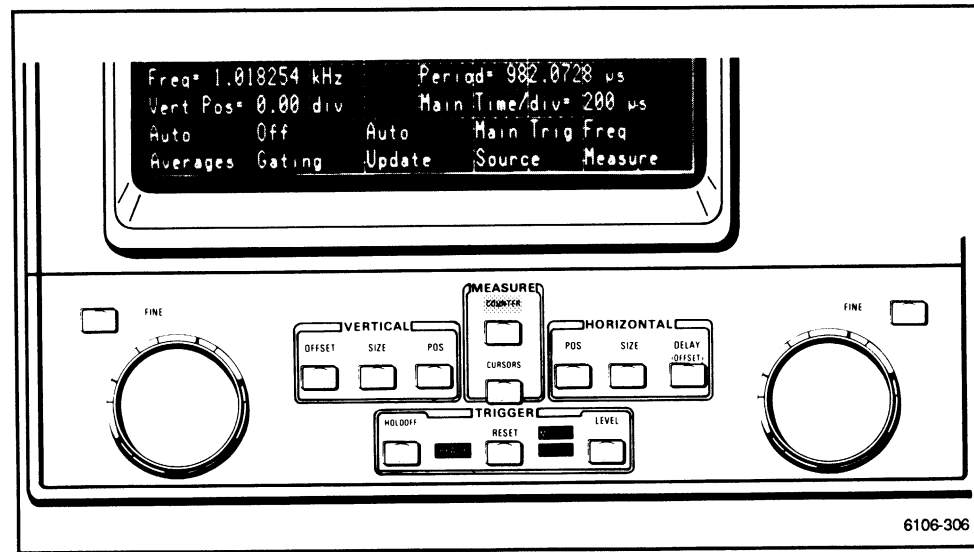

Figure 2-107. Counter/Timer menu.

3. Press the COUNTER button, located below the crt, to display the Counter/Timer menu. (See Fig. 2-107.)
4. Touch *Measure*, located at the right in the menu until **Freq** is selected.
5. Be sure that *Update* and *Averages* are set to **Auto**, *Gating* is set to **Off**, and that *Source* is set to **Main Trig**.
6. The result of the frequency measurement appears toward the lower left in the display.

**Counter View
Traces**

The counter view display can be accessed in the following manner.

NOTE

*In this example, **Count In** will be used.*

- 1. Use the procedure for performing a Basic Frequency Measurement as described in the previous example.
- 2. Press the WAVEFORM major menu button and touch *Count View*, located toward the left of the screen. To display the counter input signal, touch the *Count In* menu entry. (See Fig. 2-108.)

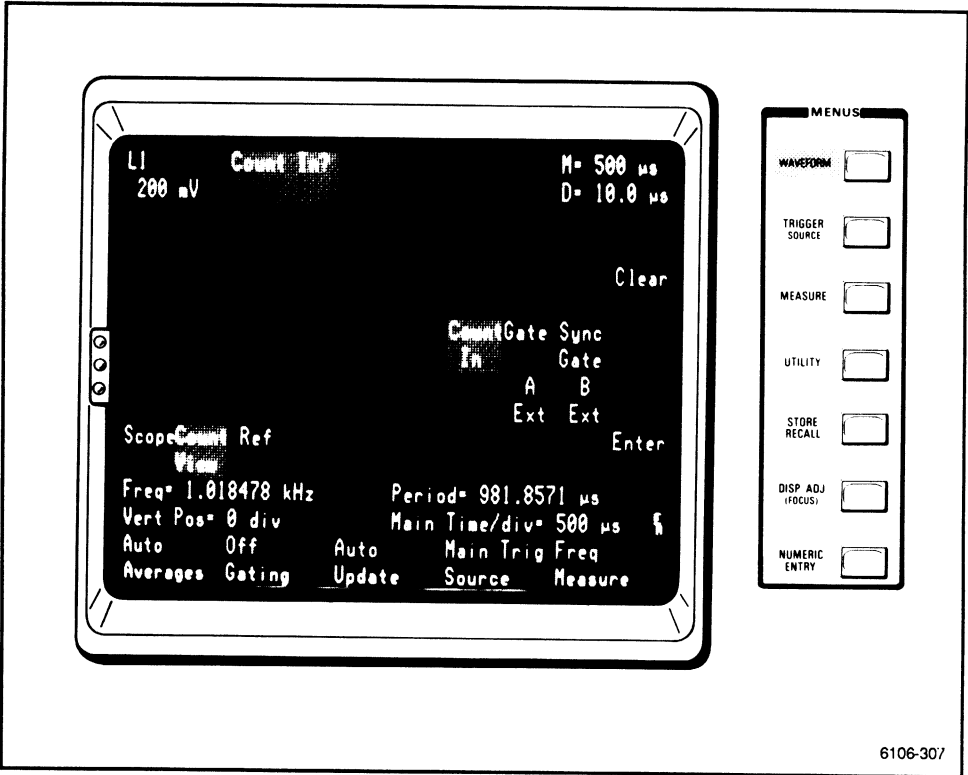

Figure 2-108. Setting the WAVEFORM menu for Counter View.

3. Turn off the menu by pressing the WAVEFORM major menu button again.
4. Use VERTICAL POS to vertically separate the two traces. (See Fig 2-109.)

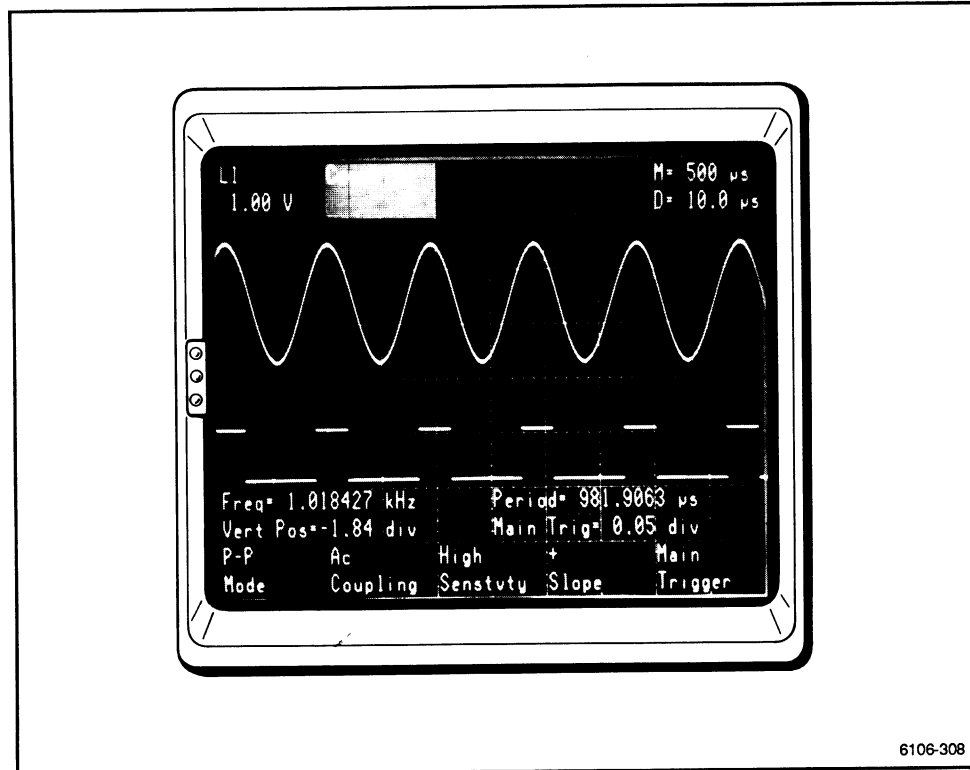

Figure 2-109. Two traces vertically separate.

5. To observe the effects of changing the triggering controls, press the TRIGGER LEVEL button and turn the right knob. Notice that the Count In trace shows a varying duty factor as the level is varied. (If the measured signal is a square wave, little or no change will be evident.)

Gated Frequency Measurements

This procedure shows how to use Gating to control the measurement interval of the counter.

1. Use the preceding procedure for a Basic Frequency Measurement.
2. Using the COUNTER menu, touch *Gating* to select **Dly1 Swp** as the gating type. (See Fig. 2-110.)

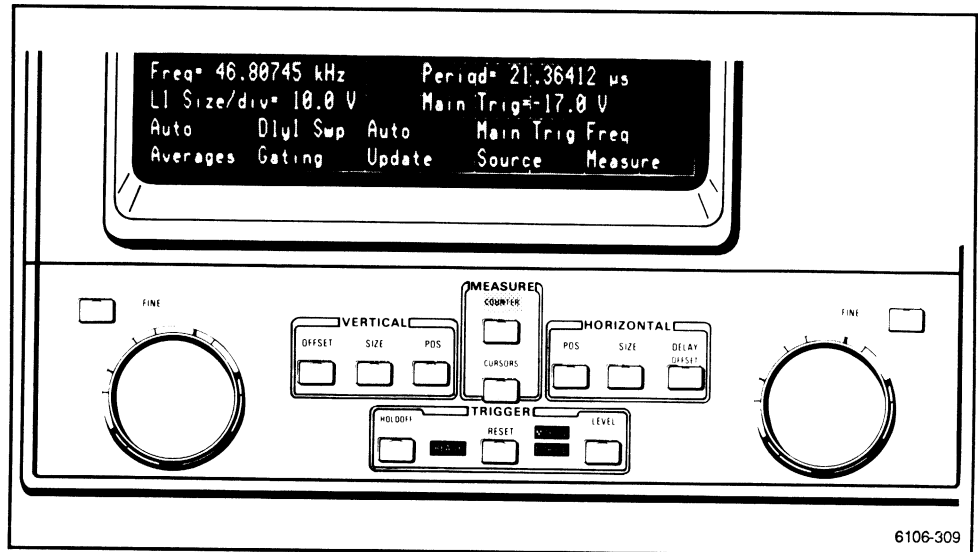

Figure 2-110. Counter/Timer menu with Dly1 Swp gating selected.

- From the WAVEFORM major menu, display the counter view signal called Gate by touching **Gate** in the *Count View* menu. Turn off the menu by pressing the WAVEFORM major menu button again. (See Fig. 2-111.)

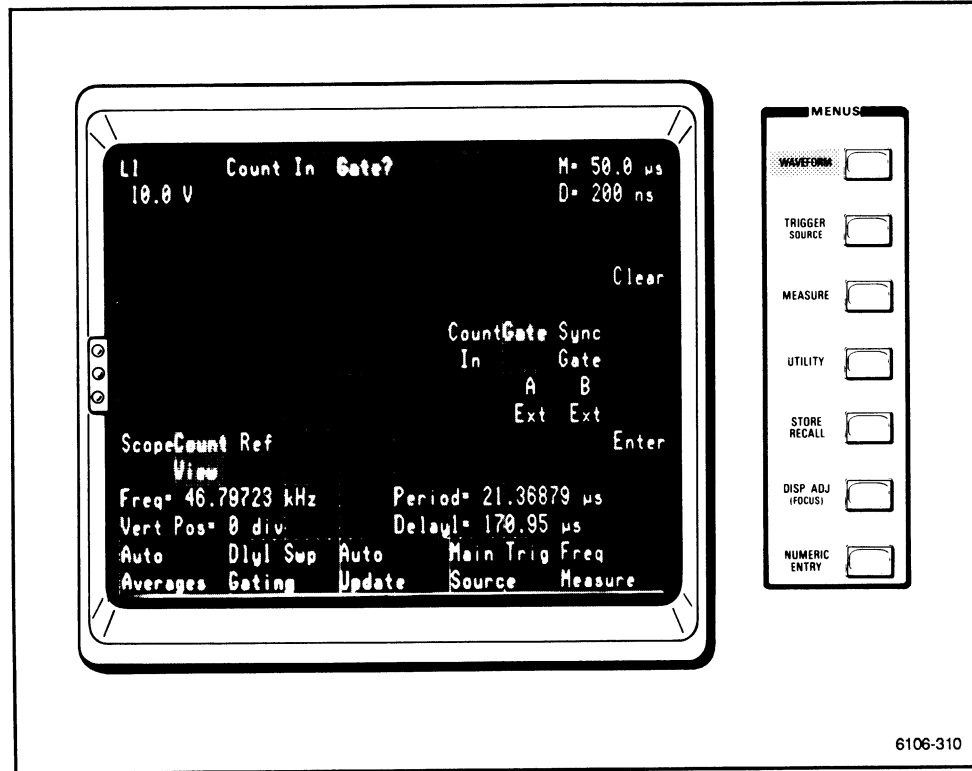

Figure 2-111. The WAVEFORM major menu with Count View selected, and the Count View menu with Gate selected.

- With the counter engaged, adjust the horizontal size of the delayed time base by pressing HORIZONTAL SIZE and touching the menu until it reads **Dly'd Time Base**. Turn the right knob until the Gate pulse width, which is displayed as Dly'd Time/div = nnn, falls within the desired measurement region. (See Fig. 2-112.)

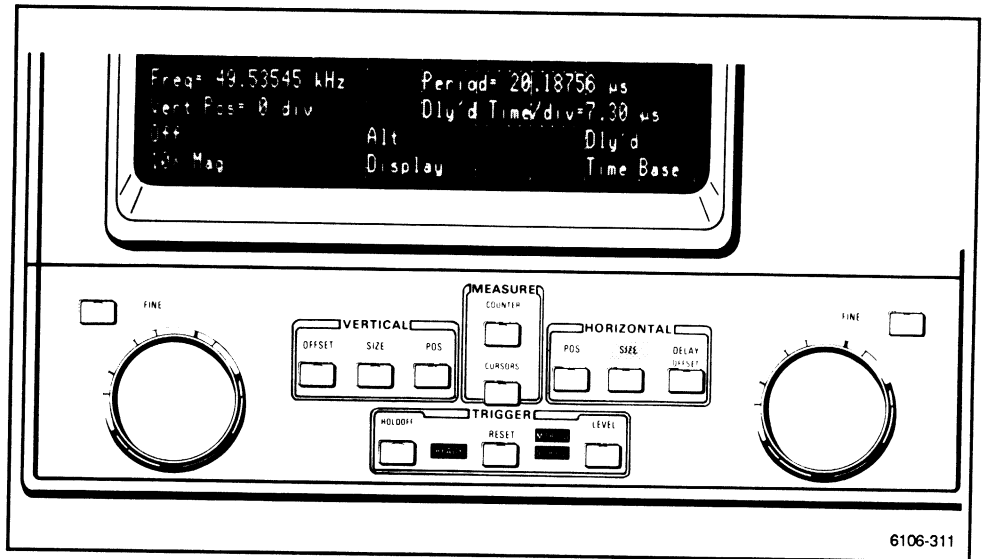

Figure 2-112. Adjusting Dly'd Time/div through HORIZONTAL SIZE menu.

- Press the HORIZONTAL DELAY button and set the *After Dly* selection to **Runs**. (**Trig'd** may be used with the proper setting of the Delayed Trigger Level, if desired). Next touch *Delay* to read **1**, and turn the right knob to align the gate pulse within the desired measurement region. (See Fig. 2-113.)

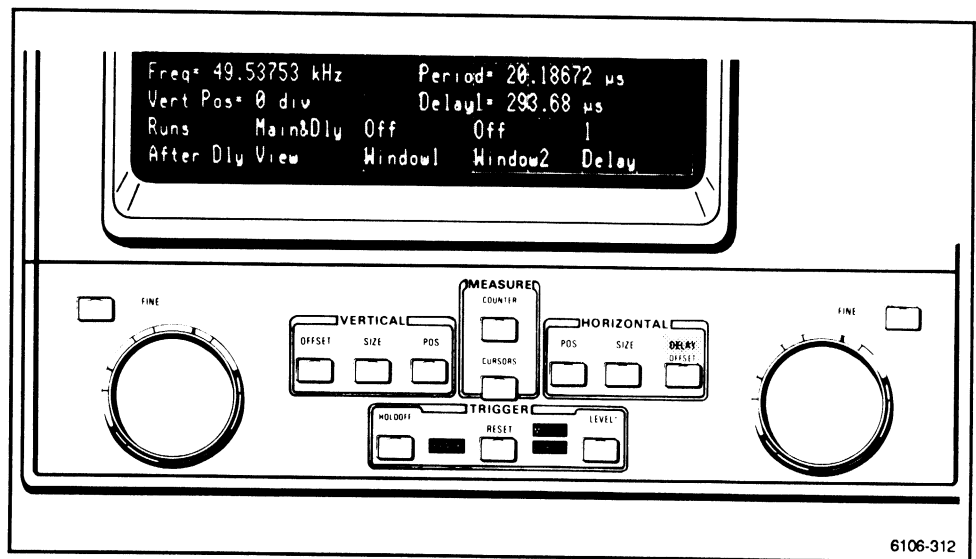

Figure 2-113. Adjusting the DELAY.

- The gated frequency measurement will appear toward the lower left in the display. (See Fig. 2-114.)

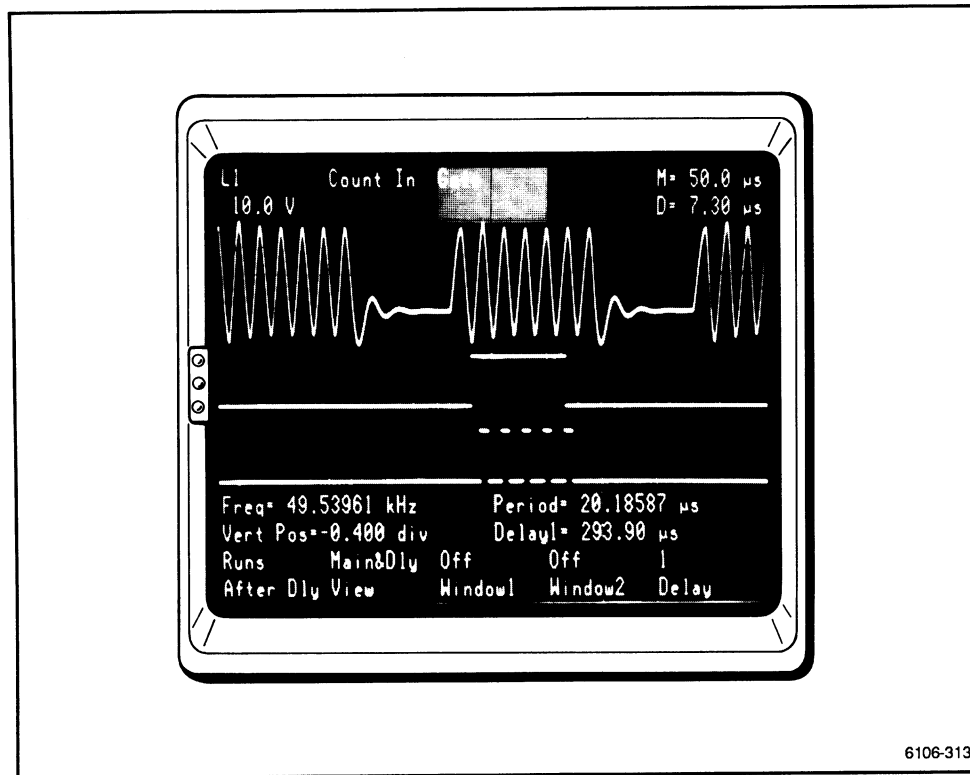

Figure 2-114. Gated frequency display.

Nulling the Counter/Timer

The procedure for nulling before a Time Interval Measurement is as follows:

1. Install amplifiers of the same model type in the LEFT and CENTER compartments.
2. Connect both probes or cables to the same signal. This can be either the signal of interest or the **Fast** rise signal from the front-panel Calibrator.
3. When the Counter/Timer has presented a measurement of the time-skew between the two signal paths, press the NUMERIC ENTRY button.
4. Touch *Count Ref*, which is to the left of the NUMERIC ENTRY menu.
5. Touch **Null** in the NUMERIC ENTRY menu. This will establish the latest Counter/Timer result as the reference for future time interval measurements (**Null** will appear in the NUMERIC ENTRY menu only if the Counter/Timer has a valid reference number. Touching **Clear** then **Enter** will return a zero reference and the results are again displayed as "absolutes."
6. Press the NUMERIC ENTRY button again to remove its menu.
7. Connect the probes or cables to the signals of interest and read the true time between them.

Nulling the other measurements is done the same way, except you need not change the connections to the signals being measured.

Time Interval Measurement of Propagation Delay

The following procedure depicts a way of measuring a time interval between events from two different input channels. In this case, the interval represents the propagation delay through an active circuit.

1. Install amplifiers of the same model type in the LEFT and CENTER compartments.
2. Connect channel L1 to the leading signal (input to the circuit under test) and press the display on/off button to display the signal.
3. Connect channel C1 to the lagging signal (output of the circuit under test) and press the display on/off button to display the signal.
4. Press the DELAY button and from its menu select *Window2* to be **On**. (See Fig. 2-115.)

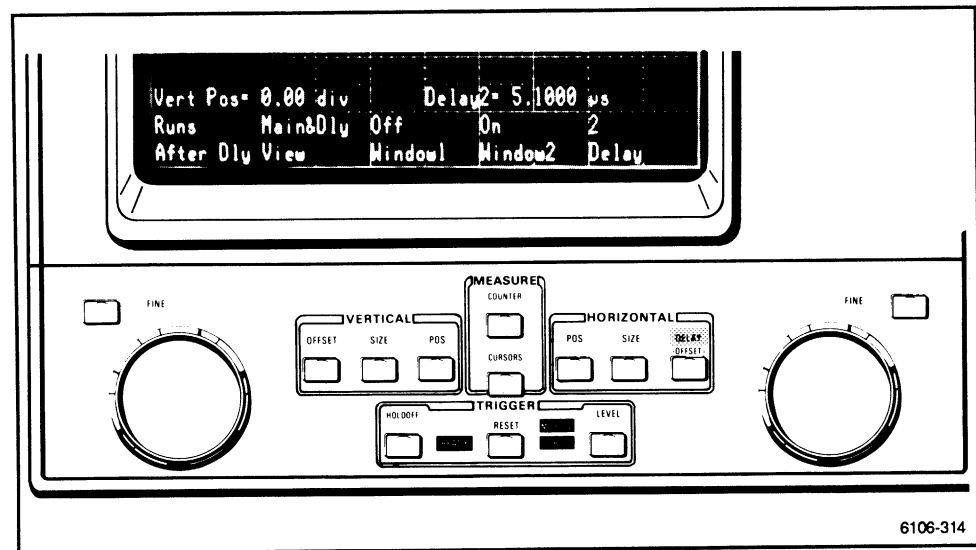

Figure 2-115. Delay menu with Window 2 set to On.

5. Press AUTOSET.
6. Select the leading trace (labeled "L1") by touching **L1**, which is located at the top left of the display.
7. From the DELAY menu, select *Window1* to be **On**.
8. Press AUTOSET. By now each main trace should have one intensified zone, each referenced to different delay adjustments. Use VERTICAL POSition to separate traces if needed.

9. To simplify the appearance of the display, select *View* (from the DELAY menu) to be **Main**.

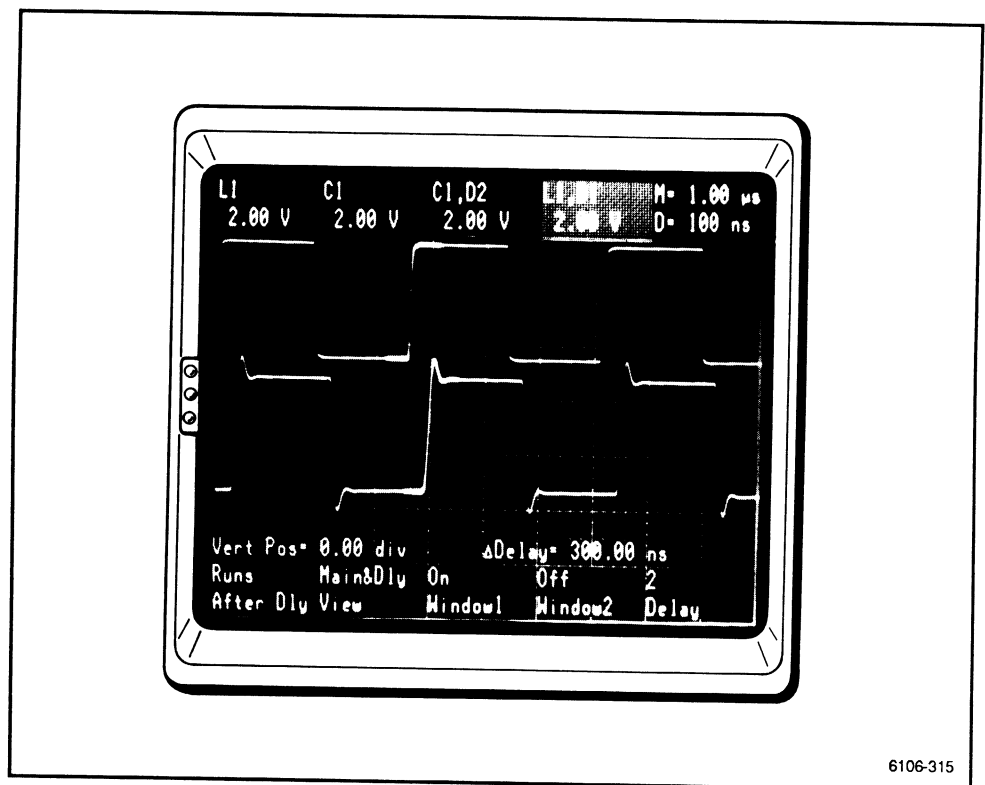

Figure 2-116. Setting delays for propagation delay measurement.

10. Use the Delay control to move the window zones to the desired event on each main trace. To do this, press the DELAY button, then turn the right knob. Touch *Delay* to alternate control from one zone to the other. (See Fig. 2-116.)
11. To measure the time between these events, press the COUNTER button and repeatedly touch *Measure* in the menu until it is set to **Time A→B**. Be certain that *Update* and *Averages* are set to **Auto** and that *Source* is set to **Swp Start**.

12. The measurement result, the time between the two events, appears at the lower left of the display as **Time D1→D2**. (See Fig. 2-117.)

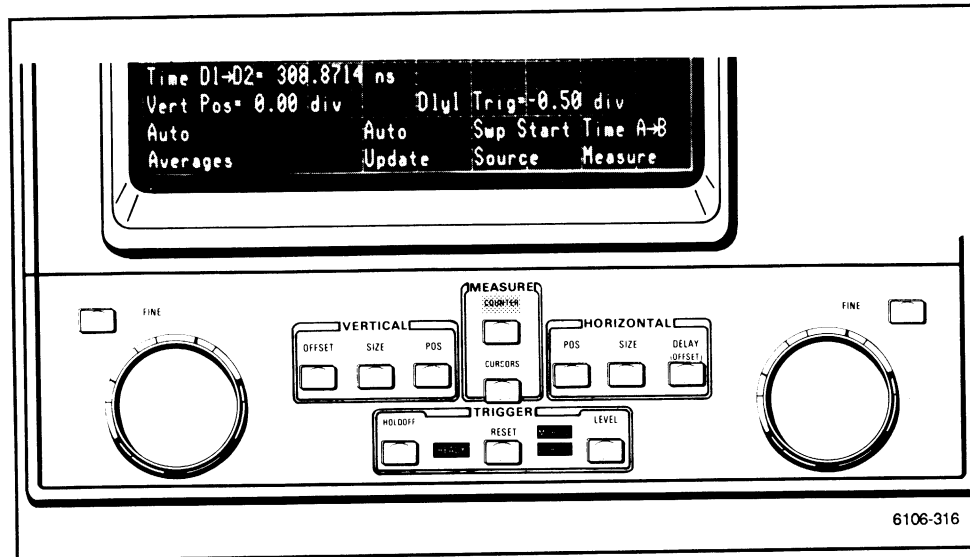

Figure 2-117. Time between events displayed as **Time D1→D2** in message area.

13. At this point, the time between the two intensified zones is controlled only by the setting of the Delay control. To further qualify the measurement location, the delayed triggers can be used.
14. For Triggered Time A→B, press the TRIGGER SOURCE major menu button. Touch **Dly1**, located to the left in the menu. It should show that L1 (the leading signal) is its trigger source. Touch **Dly2** and select C1 (the lagging signal) as its trigger source. Press the TRIGGER SOURCE button again to remove its menu.
15. In the DELAY menu, set the windows to be triggered after the delay by touching *After Dly* to select **Trig'd**. At this point, the intensified zones should begin on the transitions of interest. If they do not, then adjust the **Dly1** and **Dly2** trigger levels by pressing the TRIGGER LEVEL button and touching Trigger until Dly1 or Dly2 appears at the lower far right of the display.

GPIB and RS-232-C Interfaces

Selecting an Interface

This material describes the basic characteristics of both GPIB (IEEE-488) and RS-232-C Interfaces. Included is a functional overview of the two types of this material describes the basic characteristics of both interfaces.

Getting Started

"Getting Started" describes how to set up the oscilloscope and start some basic operations.

Command Set

This subsection describes usage, syntax, and processing conventions, along with the complete command set description. The character set table is found here.

Status and Event Reporting

This material describes the concepts and operation of the status and event reporting system.

System Performance Considerations

This subsection discusses ways for you to estimate and optimize system performance for either the GPIB or the RS-232-C interface.

Programming Applications

Utility programs have been written as examples of how to program this oscilloscope when using a common brand of controller or personal computer.

Section 3

GPIB and RS-232-C Interfaces

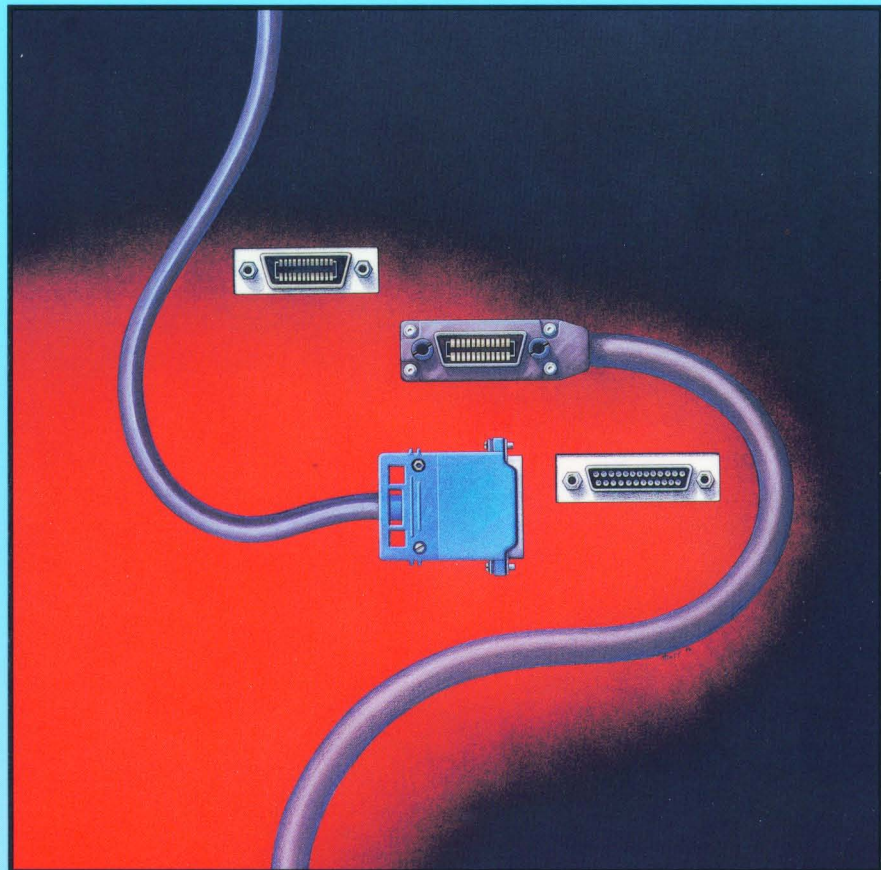

Contents

Selecting an Interface	3-2
GPIB & RS-232-C Features.....	3-2
Contrast: IEEE-488 Standard vs RS-232-C Standard.....	3-3
GPIB and RS-232-C Functional Overview.....	3-4
GPIB Interface Functions.....	3-4
GPIB Protocol.....	3-4
GPIB Messages.....	3-5
Interface Messages.....	3-5
Device-Dependent Messages.....	3-5
RS-232-C Functional Characteristics.....	3-7
RS-232-C Messages.....	3-8
Getting Started	3-9
Configuring Your System.....	3-9
GPIB.....	3-9
RS-232-C.....	3-10
Power Up Self-Test and SRQ.....	3-12
Setting Up The Interface.....	3-12
GPIB.....	3-12
RS-232-C.....	3-14
Command Rules and Data Transfer.....	3-15
Programming Notes.....	3-16
Sending Commands To The Oscilloscope.....	3-16
Responses From The Oscilloscope.....	3-18
Data Transfer Examples.....	3-21
Command Set	3-23
Command Usage Conventions.....	3-23
Syntax Conventions.....	3-23
Command Structures.....	3-25
Set Commands.....	3-25
Set Commands With Link Arguments.....	3-25
Set Commands Without Link Arguments.....	3-26
Set Commands That Mix Link and Nonlink Arguments.....	3-26
Queries.....	3-26
Queries Derived From Set Commands With Links.....	3-27
Queries Derived From Set Commands Without Links.....	3-27
Queries Without Corresponding Set Commands.....	3-27
Command Processing Conventions.....	3-28
Plug-In Slot Designators.....	3-30
Talked With Nothing To Say (TWNTS).....	3-30
ASCII Interface Operating Conventions.....	3-31
User Interfaces: I/O Synchronization.....	3-31
GPIB Remote/Local Conventions.....	3-31
I/O Buffers.....	3-32
DCL Conventions.....	3-33
Plug-In Types.....	3-33

Special RS-232-C I/O Conventions.....	3-33
RS-232-C Emulation Of GPIB Interface Messages.....	3-33
Binary Block Data Transfer.....	3-34
RS-232-C Echo.....	3-34
RS-232-C SRQ Reporting.....	3-35
RS-232-C Pin Out and Cable Connections.....	3-35
Connecting Two RS-232-C Devices.....	3-36
Example Cable Connections.....	3-36
Syntax and Descriptions.....	3-38
Autoset Commands.....	3-38
AUTOSET Command.....	3-38
Parameters.....	3-38
Query Information.....	3-39
Channel Commands.....	3-40
CH<compartment><ui> Command.....	3-40
Parameters.....	3-40
Query Information.....	3-41
General Information.....	3-42
Counter/Timer Commands.....	3-43
CTRESET Command.....	3-44
CTMEAS Command.....	3-44
CTRESULT? Query Command.....	3-44
CTFREQUENCY, CTPERIOD, CTWIDTH, CTTOTAL, CTRATIO, and CTTIME Commands.....	3-45
Parameters.....	3-45
CTCLOCK Command.....	3-46
Query Information.....	3-46
General Information.....	3-47
Cursor Commands.....	3-48
CURSOR Command.....	3-49
VCURSOR & HCURSOR Commands.....	3-49
Parameters.....	3-49
V1ABS & V2ABS and H1ABS & H2ABS Commands.....	3-49
Parameters.....	3-49
V1REL & V2REL and H1REL & H2REL Commands.....	3-49
Parameters.....	3-49
VREF? & HREF? Query Commands.....	3-50
Parameters.....	3-50
VDELTA? & HDELTA? Query Commands.....	3-50
Parameters.....	3-50
Query Information.....	3-51
General Information.....	3-51
Data Transfer Commands.....	3-52
WFMPRE Command.....	3-52
Parameters.....	3-53
CURVE Command.....	3-53
INPUT Command.....	3-54
OUTPUT Command.....	3-54

ENCDG Command.....	3-54
Parameters.....	3-54
WAVFRM? Query Command.....	3-55
SET? Query Command.....	3-55
Query Information.....	3-55
General Information.....	3-56
Diagnostic Commands.....	3-57
TEST Command.....	3-57
Query Information.....	3-57
General Information.....	3-58
Display Commands.....	3-59
DISPLAY Command.....	3-59
Query Information.....	3-59
Intensity Commands.....	3-60
INTENSITY Command.....	3-60
Parameters.....	3-60
CONTRAST Command.....	3-60
Parameters.....	3-60
Query Information.....	3-61
General Information.....	3-61
Measurement Commands.....	3-62
MSLIST Command.....	3-62
MEAS? Query Command.....	3-63
AUTOMEASURE Command.....	3-63
Parameters.....	3-63
Query Information.....	3-63
General Information.....	3-64
Miscellaneous Commands.....	3-65
SELFCAL Command.....	3-65
Parameters.....	3-65
CALSTATUS? Query Command.....	3-66
REDIRECT Command.....	3-66
Parameters.....	3-66
DEBUG Command.....	3-66
Parameters.....	3-66
LONGFORM Command.....	3-66
TIME Command.....	3-66
DATE Command.....	3-67
DT Command.....	3-67
ABSTOUCH Command.....	3-67
FPANEL Command.....	3-67
INIT Command.....	3-68
HELP? Query Command.....	3-68
DATIME? Query Command.....	3-69
UPTIME? Query Command.....	3-69
POWERON? Query Command.....	3-69

CALIBRATOR Command.....	3-69
Parameters.....	3-69
SPEAKER Command.....	3-70
Query Information.....	3-70
Probe ID Commands.....	3-73
PROBE Command.....	3-73
Parameters.....	3-73
Query Information.....	3-73
RS-232-C Control Commands.....	3-74
RS232 Command.....	3-74
Parameters.....	3-74
Query Information.....	3-76
Status and Event Commands.....	3-77
RQS Command.....	3-77
SRQMASK Command.....	3-78
Parameters.....	3-78
UID Command.....	3-78
EVENT? Query Command.....	3-78
EVQTY? Query Command.....	3-78
ALLEV? Query Command.....	3-78
ID? Query Command.....	3-79
STBYTE? Query Command.....	3-79
IDPROBE? Query Command.....	3-79
VERSION? Query Command.....	3-79
CONFIG? Query Command.....	3-79
Parameters.....	3-79
Query Information.....	3-80
Store Recall Commands.....	3-82
RECALL Command.....	3-82
STORE Command.....	3-82
ERASE Command.....	3-82
Parameters.....	3-82
Text Commands.....	3-83
TEXT Command.....	3-83
Parameters.....	3-83
Query Information.....	3-83
General Information.....	3-83
Time Base Commands.....	3-84
TBDISPLAY Command.....	3-84
TBGATEOUT Command.....	3-84
TBMAIN & TBDELAY Commands.....	3-85
Parameters.....	3-85
Query Information.....	3-86

Trigger Commands.....	3-87
TRMAIN, TR1DELAY & TR2DELAY, and TRAEXT & TRBEXT Commands.....	3-87
Parameters.....	3-88
Query Information.....	3-88
General Information.....	3-89
Additional Constraints.....	3-89
Trigger Holdoff Commands.....	3-91
HOLDOFF Command.....	3-91
Parameters.....	3-91
HOEVENT Command.....	3-93
Parameters.....	3-93
HOCOUNTDOWN Command.....	3-93
Parameters.....	3-93
Query Information.....	3-93
Waveform Commands.....	3-95
TRACE<ui> Command.....	3-96
Parameters.....	3-96
SELECT Command.....	3-96
Parameters.....	3-96
CLEAR Command.....	3-97
Query Information.....	3-97
General Information.....	3-98
Additional Constraints.....	3-98
Window Delay Commands.....	3-100
WIN1 & WIN2 Commands.....	3-100
Parameters.....	3-100
Query Information.....	3-100
Window Trigger Commands.....	3-101
WTMODE Command.....	3-101
Parameters.....	3-101
Query Information.....	3-101
Abbreviating Command Set Words.....	3-102
Character Set.....	3-106
Status and Event Reporting.....	3-109
Using SRQ with IEEE-488.....	3-109
Using SRQ with RS-232-C.....	3-109
Masking and Controlling Requests.....	3-109
RQS Command.....	3-109
SRQMASK Command.....	3-111
Event Reporting.....	3-111
Event Handling.....	3-112
Reading the Event Registers.....	3-112
RQS OFF; Status Byte Queries.....	3-112
RQS OFF; Event Queries.....	3-112
RQS ON; Status Byte Queries.....	3-113
RQS ON; Event Queries.....	3-113

SRQ Responses.....	3-114
Status Byte Definition.....	3-114
Event Code Definition.....	3-116
Event Priorities.....	3-117
Event Codes.....	3-118
System Performance Considerations.....	3-125
Know Your System.....	3-125
Estimating System Performance.....	3-126
Instrument Set-up Time.....	3-126
Data Transfer Time.....	3-127
Data Processing Time.....	3-130
Human Interaction Time.....	3-131
Optimizing System Performance Factors.....	3-131
Instrument Set-up.....	3-131
Data Transfer.....	3-131
Data Processing.....	3-132
Human Interaction.....	3-133
Programming Applications.....	3-135
Utility Programs For HP 200 & 300 Series Controllers.....	3-135
Utility Programs For IBM PC-XT-AT Controllers.....	3-142

GPIB and RS-232-C Interfaces

The 11301 and 11302 Programmable Oscilloscopes have two external interfaces for data transfer and instrument control (see Fig. 3-1).

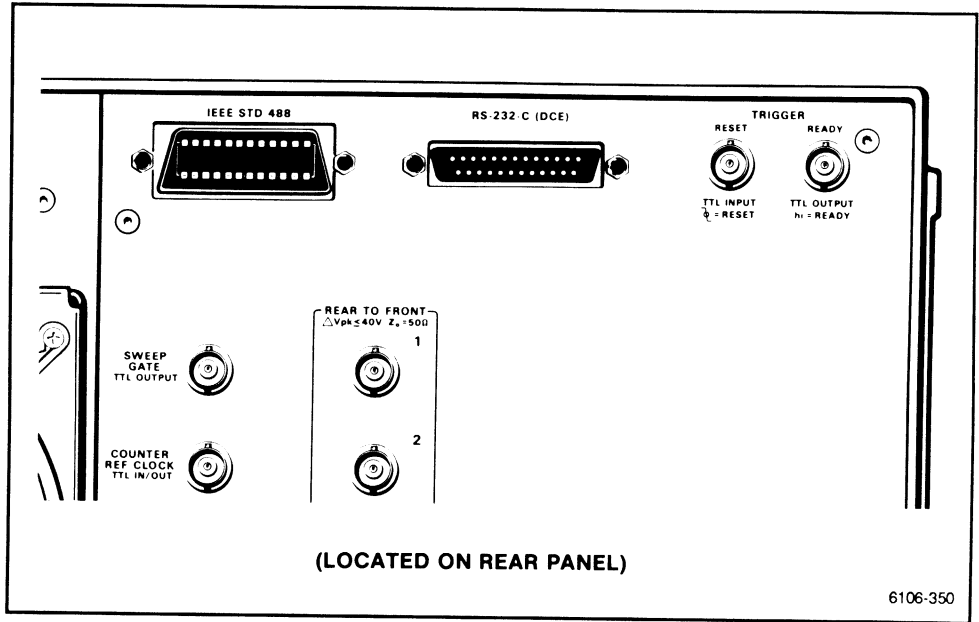

Figure 3-1. GPIB & RS-232-C Ports (Rear Panel View).

This section begins with a brief overview of each interface. The level of information is directed toward users with a basic familiarity of programming, GPIB, and RS-232-C concepts. Readers with little knowledge of these concepts should refer to introductory texts on these subjects for help in learning to use the oscilloscope in computer-controlled systems. However, some beginners may find that with careful reading of this entire section, they can use the features the external interfaces provide.

The overview material is followed by "Getting Started" information, which provides more advanced users enough information to operate the oscilloscope with either external interface.

The remaining information provides experienced users with all the reference information necessary for developing their own application programs.

Selecting an Interface

Which Interface Do I Select? Your specific measurement requirements dictate which communication interface best suits your application needs. Considerations include:

- whether you require a single device or multiple device system environment,
- what kind of data transfer speeds are needed,
- what your available controller and software require,
- what your programming experience is, and
- what your interrupt handling (operator or process-generated) considerations are.

The following interface descriptions should help determine application requirements and which interface best fulfills those requirements.

GPIB & RS-232-C Features

The IEEE-488 General Purpose Interface Bus (GPIB) provides the oscilloscope with an external communication path. Its key features include:

- Remote Instrument Control
- Reliable Bi-directional Asynchronous Parallel Data Transfer
- Device Status and Event Reporting
- Multiple Instrument Control

The RS-232-C describes another external communication path. Key features include:

- Common Full-duplex Communication Interface
- Asynchronous Serial Data Transfer
- Compatibility with Many Personal Computers
- Provision for Device Clear and Service Requests
- Dedicated Connection to One Device

In addition, a Tektronix device-dependent English-like language is specified to make the oscilloscope commands easy to use and understand. The operator uses the same message syntax or format with both interfaces (see the Command Set later in this section). Data transmissions are made in either ASCII or binary format. The compact binary transmission format provides maximum throughput.

Contrast: IEEE-488 Standard vs RS-232-C Standard

The GPIB is based on the IEEE Standard 488-1978 Digital Interface for Programmable Instrumentation, which defines interface mechanical, electrical, functional, and bus protocol elements that enable data to be transferred between similarly defined devices. The RS-232-C is based on EIA Standard RS-232-C for interfacing between data terminal equipment and data communication equipment employing serial binary data interchange, which defines basic hardware related elements, but without data handshake or bus protocol specifications.

The following comparisons contrast operating parameter differences, but are not instrument specifications.

The GPIB interface uses a bit-parallel, byte-serial binary data format with a maximum transmission rate of 500 kilobytes per second, while the RS-232-C interface uses a bit-serial, byte-serial binary data format with a maximum transmission rate of 9600 bits per second.

The GPIB allows for interconnection of up to 15 devices on one contiguous bus in a linear or star configuration, while the RS-232-C provides point-to-point connection of two devices. The total cumulative GPIB transmission path length (cabling) must not exceed 20 meters (65 feet), while the total RS-232-C transmission path length (without data communication facilities, i.e., modem and telephone lines) may not exceed 15 meters (50 feet).

The GPIB has low-level interface control messages for bus function and signal manipulation by the operator. The RS-232-C does not provide operator low-level interface control.

GPIB and RS-232-C Functional Overview

GPIB Interface Functions

Each interface function is a system element that provides the basic operational facility through which the mainframe can receive, process, or send messages over the GPIB.

The oscilloscope implements the following IEEE Standard 488-1978 interface functions and their indicated subsets:

- Source Handshake (SH1)
- Remote Local (RL1)
- Acceptor Handshake (AH1)
- Device Clear (DC1)
- Talker (T6)
- Parallel Poll (PP0)
- Listener (L4)
- Device Trigger (DT1)
- Service Request (SR1)
- Remote/Local (RL1)*
- Controller (C0)

*The 11301 FPANEL command emulates this function.

For a description of these functions and their subsets, see the IEEE Standard 488-1978 Section 2.1 through 2.12.5.

GPIB Protocol

The GPIB interface enables the instrument to communicate with various peripheral devices. Devices connected to the bus perform these roles:

Talkers—are instruments that can send messages and data over the bus. Only one device can be addressed to talk at once.

Listeners—are instruments that can accept messages and data over the bus. Only devices addressed to listen can do so.

Controllers—determine, through software routines, which instrument will talk and which will listen during any time interval. The controller may also assign itself as a talker or listener whenever required by the application program. The controller uses special codes and commands (called interface messages) to configure some or all devices on the bus for these or other interface functions. The controller application program also contains the unique device coding (device dependent messages) that directs the system instruments to perform tasks (e.g., taking measurements, storing and sending the results to a plotter).

The oscilloscope mainframe can be a talker or a listener, but not a controller.

GPIB Messages

Basically, there are three types of system or remote messages; interface, device dependent, and status. Interface messages control the interface, and device dependent messages control the instrument functions. Status messages (partly defined by the IEEE-488 standard and partly by the device designer) report the device operating condition. Status messages are described later in this section.

Interface Messages

Interface messages cause state transitions within the interface functions of the instruments to which they are addressed. These kinds of messages occur, most often, at a level that is transparent to the user. That is, a high-level GPIB driver program takes care of all the necessary housekeeping interface functions, whatever the controller operating system and application program calls might be. However, the low-level interface (control) messages may be of use when, for example, you wish to write an application program to bypass the system controller in order to send messages from the mainframe directly to another device. Interface messages may only be sent by the controller in charge. Interface messages are divided into four classes (for use with this oscilloscope):

Addressed Commands—Only instruments on the bus that are addressed to listen receive these commands.

Universal Commands—All instruments on the bus receive these commands, regardless of whether addressed.

Listen Addresses—These are indirectly set by the user in hardware or software. When sent, they determine which devices listen for messages.

Talk Addresses—These are similarly set in hardware or software. When sent, they determine which device can talk.

These classes of messages occur without operator intervention, except for the initial setting of an 11301/11302 primary address value that determines the resultant values of its talk and listen addresses. This primary address is used by the controller to uniquely identify the 11301/11302 for sending and receiving messages. The programmable range of 11301/11302 primary addresses is 1 through 31.

Programming with interface addresses and commands (low-level interface messages) is not discussed in this manual. However, some low-level settings (e.g., primary address) are required to set up the bus for use. See the "Getting Started" information, later in this section.

Device-Dependent Messages

The coding and device functions are not specified in the IEEE Standard 488-1978. Device-dependent messages are passed between the device (dependent) functions and the message coding logic via the specified interface functions (see Fig. 3-2.)

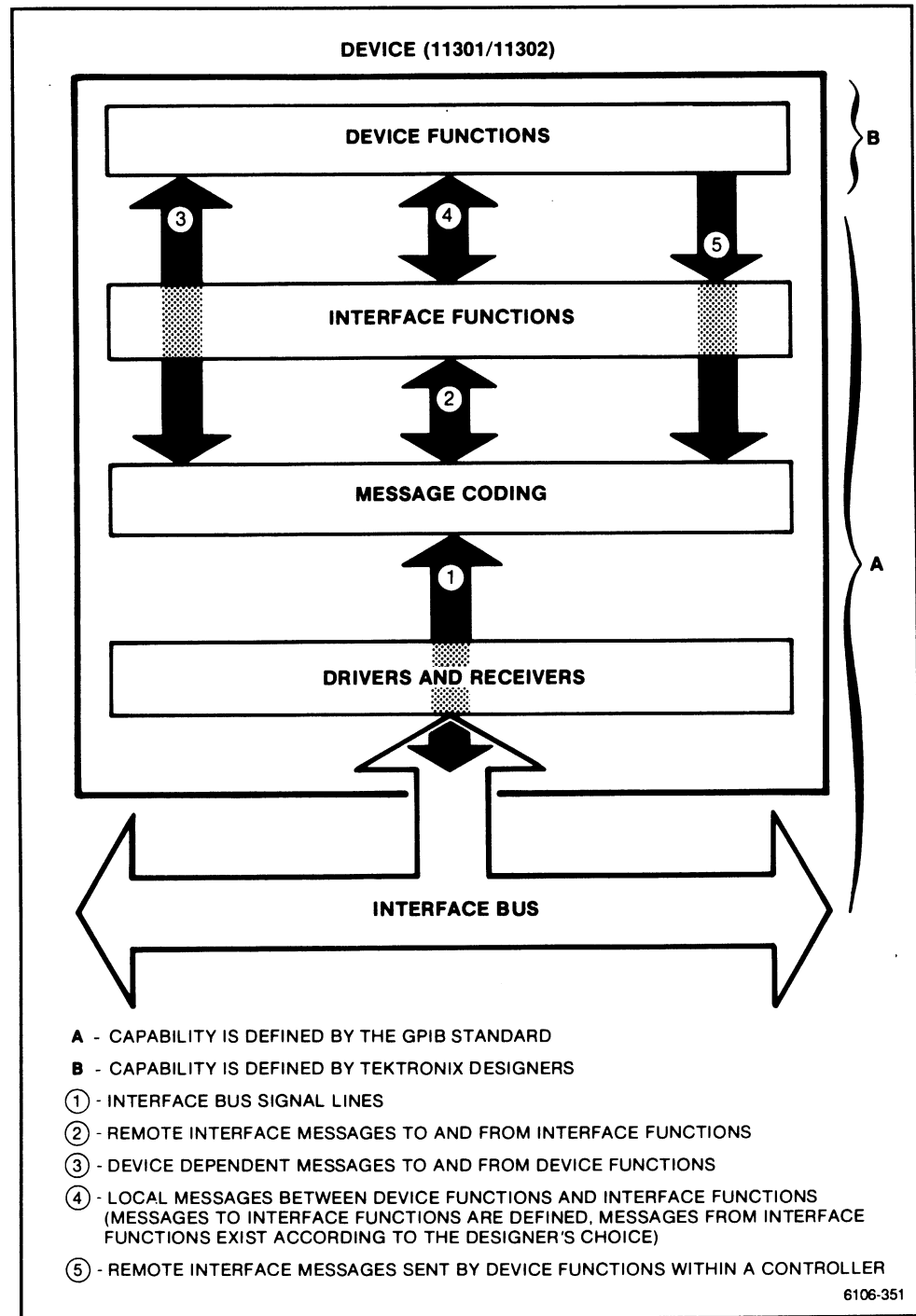

Figure 3-2. Functional Partition Within A Device.

Because IEEE Standard 448-1978 does not specify device-dependent message parameters, Tektronix has created the "Tektronix Codes, Formats, Conventions, and Features Standard" (hereinafter called Tek Codes and Formats Standard). It defines device-dependent message formats and codings to improve compatibility among instruments that comply with the IEEE 488 Standard, thus reducing cost and time required to develop system and application software by making it easier to generate a usable code. The Tek Codes and Formats Standard provides a command language syntax that standardizes the types of communication elements from which messages can be constructed and the rules by which these elements can be combined to transmit meaningful messages. The GPIB message character coding for this oscilloscope is based on the American Standard Code for Information Interchange (i.e., 8-bit ASCII character set).

See the Command Set Syntax and the Getting Started discussions, later in this section, for detailed information on sending and receiving instrument commands or data over the GPIB bus.

RS-232-C Functional Characteristics

The RS-232-C interface is a serial, full-duplex (simultaneous two-way), asynchronous communication port. Interconnected computers and devices follow a first-level protocol (set of rules) that ensures the orderly transfer of information for serial, asynchronous operation (see Fig. 3-3). The sequence of events is:

1. A start bit is sent, alerting the receiver that a character is coming.
2. The character data bits are sent.
3. Optionally, a parity bit for error detection is sent.
4. One or two stop bits are sent to allow the receiver settling time before the next character arrives.

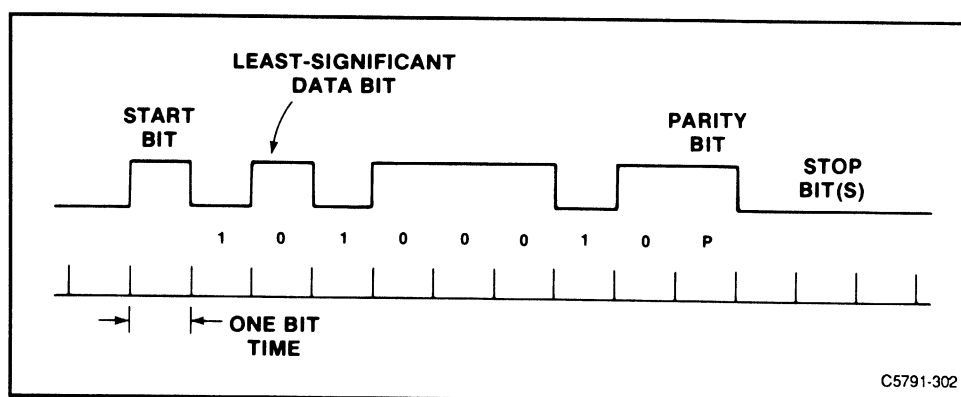

Figure 3-3. Asynchronous Serial Transmission.

This process is transparent to the user, although the baud rate, start bits, parity, and stop bits must initially be selected.

Besides these basic transmission functions, the mainframe allows the remote user to select transmission delay time, controller display echoing, flagging for transmission start and stop (handshaking), and the SRQ reporting mode.

For detailed descriptions of these functions, see the Command Set syntax and semantics later in this section.

RS-232-C Messages

As mentioned above, serial asynchronous transmission begins with a start bit, followed by data bits that form the characters of a meaningful message. The specific encoding used determines the number of data bits and the representative meaning of the binary code (pattern) that forms the intended message.

The RS-232-C standard does not define device-dependent messages. The RS-232-C interface character message coding is user specified as either 7- or 8-bit ASCII, and, as mentioned before, the RS-232-C interface command language and syntax is the same as that of the GPIB port.

A complete description of the Command Set is given later in this section. For detailed information on sending and receiving data over the RS-232-C interface, see the following "Getting Started" discussion.

For more information about GPIB and RS-232-C specifications and operations, refer to IEEE Standard 488-1978, available from the

Institute of Electrical and
Electronics Engineering, Inc.,
345 East 47th Street,
New York, New York 10017

and refer to the EIA Standard RS-232-C available from the

Electronics Industries Association,
Engineering Dept.,
2001 Eye Street, N.W.,
Washington, D.C. 20006

Getting Started

Configuring Your System

GPIB

The GPIB system can be cabled in two configurations: star or linear (see Fig.3-4).

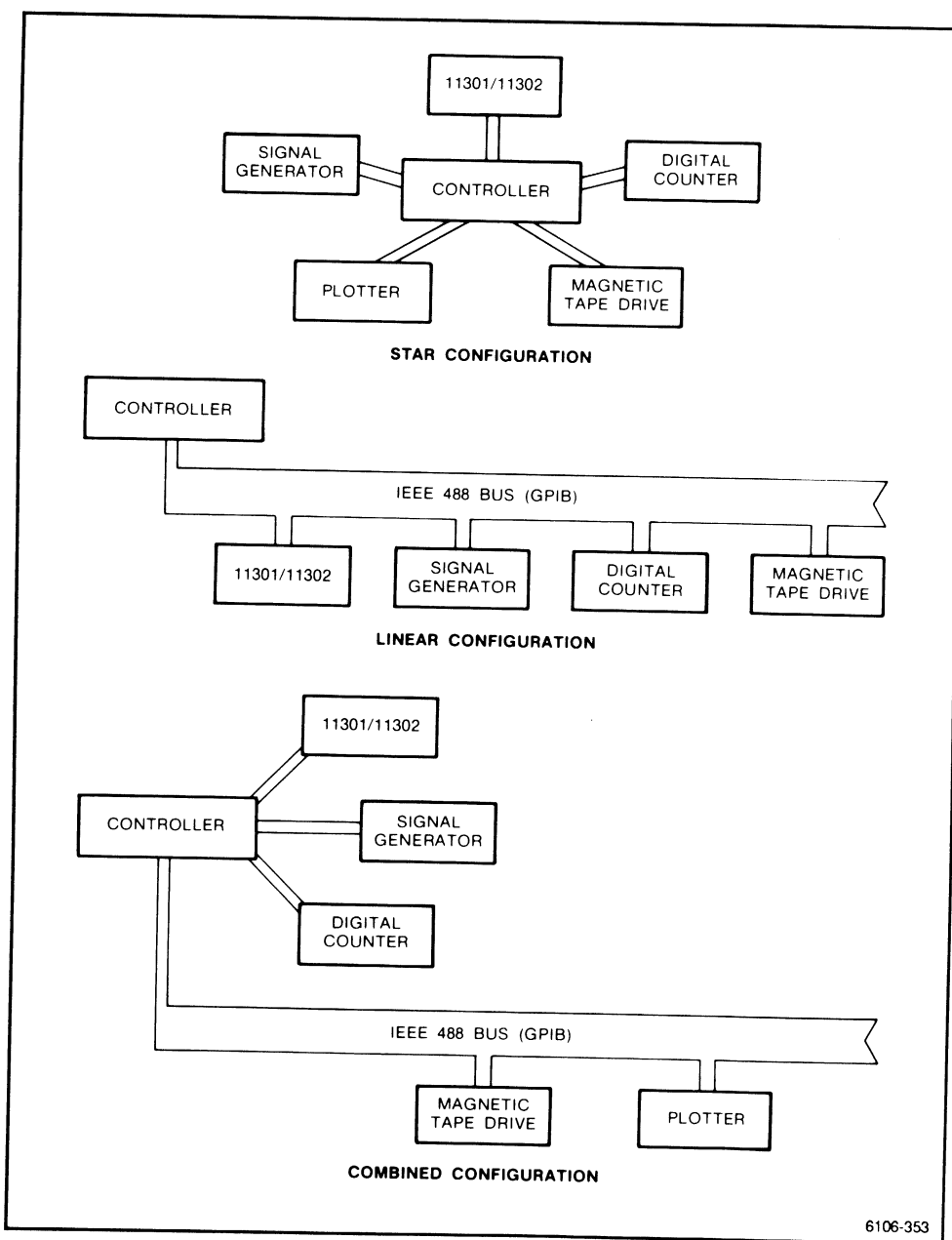

Figure 3-4. GPIB System Configurations.

While the star configuration is recommended, the two configurations can be mixed if the total cable length does not exceed 20 meters, and the instruments are connected according to a few rules:

1. No more than 15 total devices (including the controller) can be included on a single bus.
2. In order to maintain bus electrical characteristics, one device load must be connected for every two meters of cable (generally each instrument represents one device load to the bus).
3. At least one-half of the device loads must be powered on. An IEEE Std 488-1978 GPIB cable is required to interconnect devices. See the recommended accessories list in the Tektronix Catalog for the part number, or contact your local Tektronix Field Representative.

RS-232-C

The RS-232-C interface provides a point-to-point connection between the data terminal equipment (DTE) and the data communication equipment (DCE) (see Fig. 3-5).

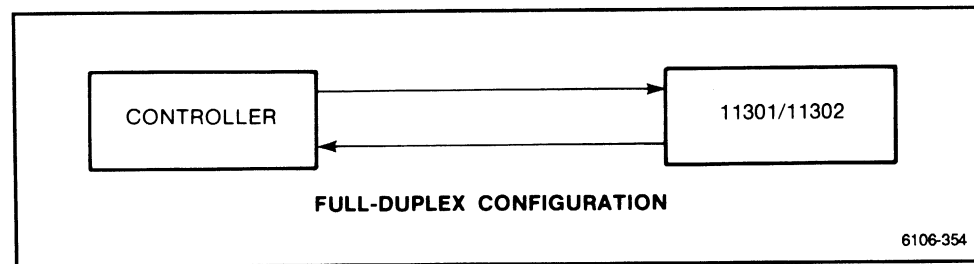

Figure 3-5. RS-232-C Point-to-point Connection.

Only the signal lines and the electrical aspects of the interface are specified; connector mechanical details are not. Most applications use a 25-pin male D-connector on the data terminal equipment (e.g., "dumb" terminal, etc.) and a 25-pin female D-connector on data communication equipment (e.g., 11301, or modem).

A straight-through, male-to-female cable of less than 50 feet is used for local DTE-to-DCE configurations. However, because each piece of electronic equipment with an RS-232-C interface can be configured as a DCE, a special male-to-male adapter (null-modem) cable is required for local (under 50 feet) DCE-to-DCE communications. This allows the proper connection for each device to emulate the DTE signals necessary for handshaking data transfers. This oscilloscope is configured as a DCE device (see Fig. 3-6 below).

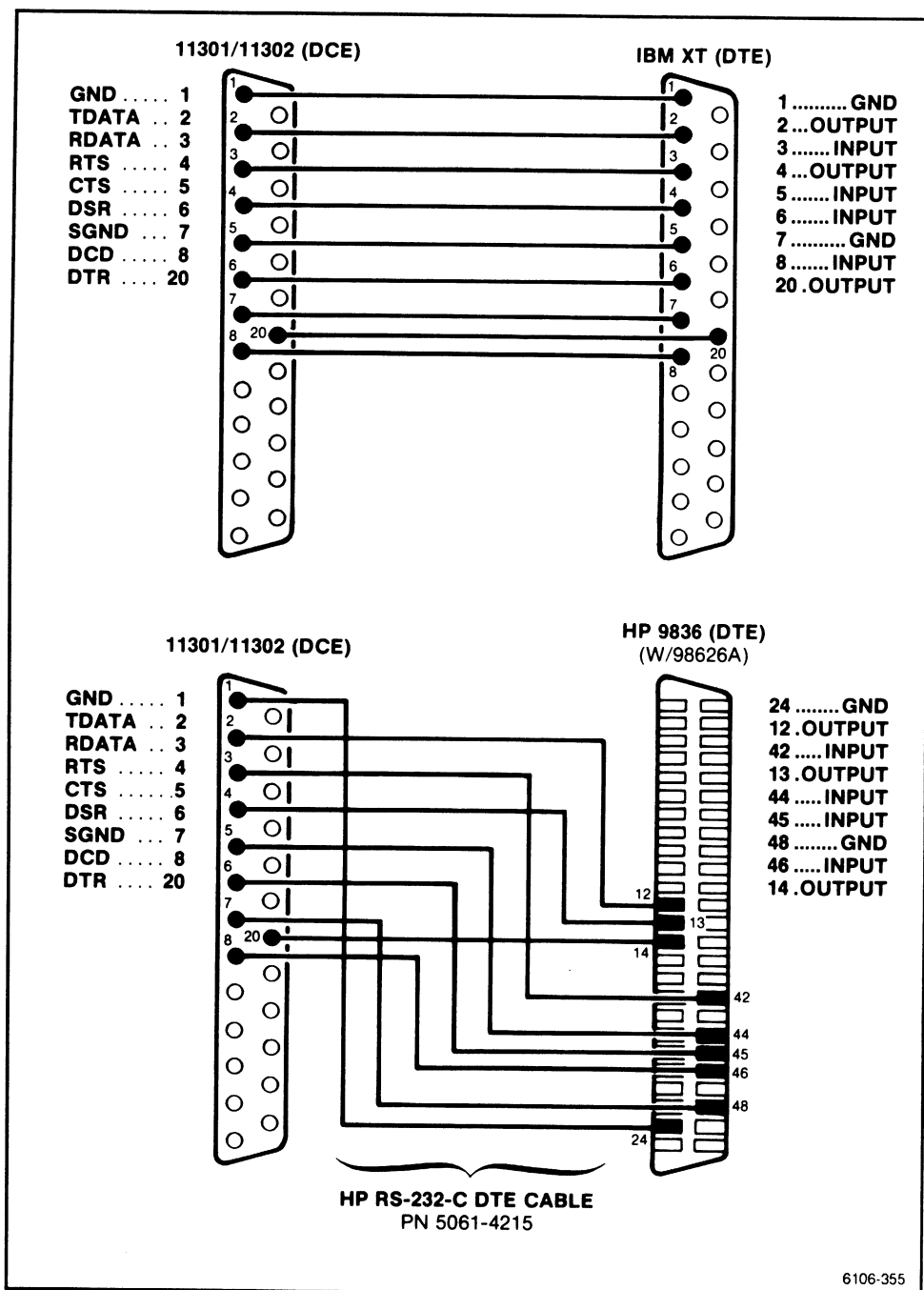

Figure 3-6. RS-232-C Port Pinouts.

See the recommended accessories list in the Tektronix Catalog for the cable part number, or contact your local Tektronix Field Representative.

Power Up Self-Test and SRQ

At power up, the oscilloscope performs a self-test (Test), and upon successful completion, it asserts the SRQ signal line on the GPIB. The instrument status byte indicates a power-up. The Event Code indicates whether a normal power-up or a selftest failure has occurred.

NOTE

If a problem is detected, refer the instrument to qualified service personnel.

Setting Up The Interface

GPIB

This interface is set up via the GPIB Utility Menu.

1. Touch the Utility Menu button to the right of the display area. The Utility Major Menu should appear in the major menu area, in the center of the display area.
2. Touch the GPIB label on the left side of the display of the major menu. The GPIB Utility menu should appear in the right-hand portion of the menu area.
3. The GPIB communication interface requires selection of the Mode, Address, and Terminator parameters. The specific settings are determined by hardware or software constraints (see Fig. 3-7 for typical settings). The interface is ready for operation.

Mode—the communication Talk/Listen or Off Bus.

Address—the primary address is from 1 to 31 (off Bus).

Terminator—the message terminator is "EOI or LF" or "EOI".

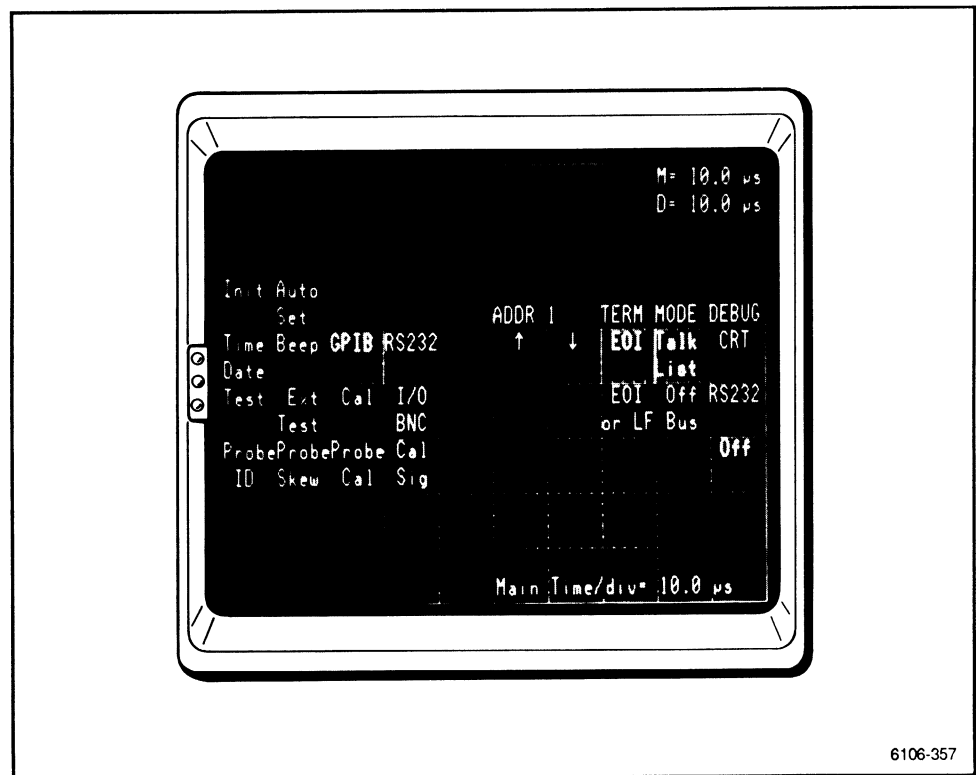

Figure 3-7. Typical GPIB Settings.

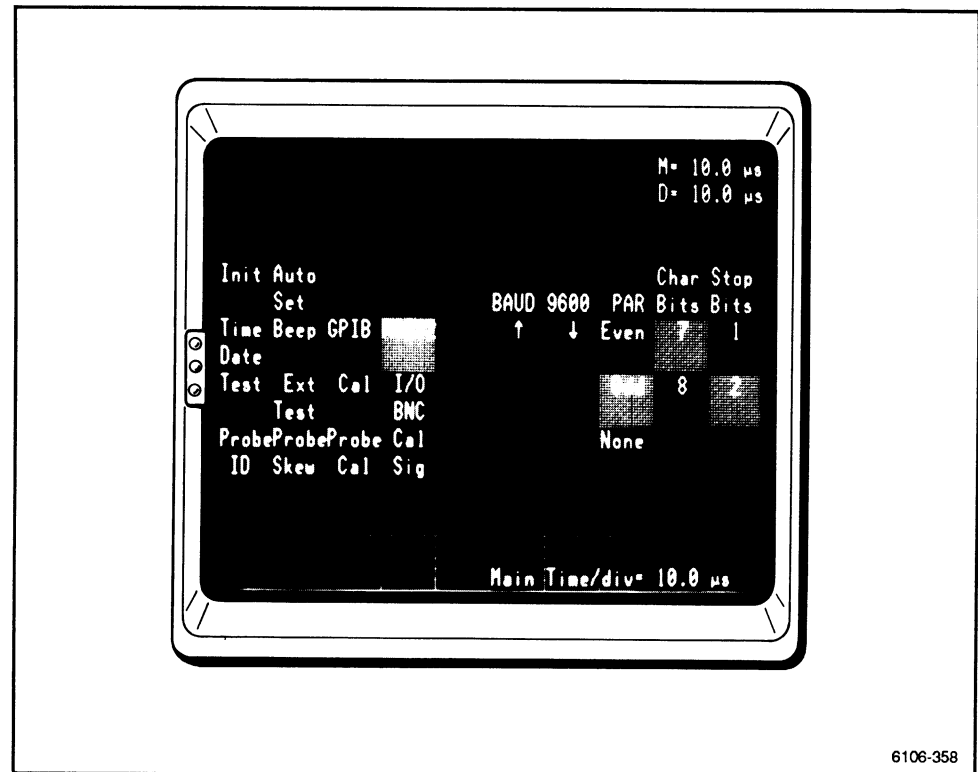

Figure 3-8. Typical RS-232-C Settings.

RS-232-C

This interface is set up via the RS232 Utility menu.

1. Touch the Utility Menu button to the right of the display area. The Utility Major Menu should appear in the center of the display area.
2. Touch the RS232 label in the major menu area to call up the RS232 Utility Menu in the right-hand portion of the menu area.
3. You must set baud rate, stopbits, character bits, and parity for the RS-232-C communication interface. Specific settings are determined by hardware or software constraints of the other RS-232-C device (see Fig. 3-8 for typical settings). The power-up value for each of these parameters is the value last set before power-down.

See the earlier explanation of the RS232 Utility menu (Section 2) for more front-panel parameter details. After setting the appropriate items in step three, the interface is ready for operation. However, there are other pertinent parameters that you may wish to remotely specify, such as DELAY, ECHO, FLAGGING, SRQ, EOL, and HARDLINE. These appear in the RS232 control Commands later in this section.

Programming Notes

Each instrument controller has unique requirements for forming and exchanging messages with the oscilloscope. See the controller user manual for the necessary protocols. A controller-specific language protocol requirement for sending messages over the GPIB depends on the application programming language and its device I/O driver. Many languages contain the necessary high-level GPIB I/O driver so that operators need not include low-level interface function calls in the GPIB application programs (unless so desired and the programming facilities are available).

NOTE

While the oscilloscope accepts input from three sources (GPIB interface, RS-232-C interface, and front-panel touch screen interface), it is not a multiple-user instrument, nor will it synchronize the order of multiple interface inputs. Configuring the oscilloscope to activate (engage in I/O) more than one interface simultaneously may cause loss of data or unpredictable results..

Sending Commands To The Oscilloscope

Table 3-1 lists typical 11301/11302 set commands as they would appear in an HP BASIC or IBM BASICA application program for the GPIB. In these examples, it is assumed that "@Rt" and "RT%" identify the 11301/11302 (primary address) assigned to the controller GPIB port.

TABLE 3-1
Examples of Set Commands

Command Class	Controller	Program Line
Channel	HP 200,300	OUTPUT @Rt;"CHL1 SENSITIVITY:1"
	IBM PC*	WRT\$ = "CHL1 SENSITIVITY:1" CALL IBWRT(RT%,WRT\$)
Timebase	HP 200,300	OUTPUT @Rt;"TBMAIN TIME:1E-6"
	IBM PC*	WRT\$ = "TBMAIN TIME:1E-6" CALL IBWRT(RT%,WRT\$)
Waveform	HP 200,300	OUTPUT @Rt;"TRACE1 DESCRIPTION:L1"
	IBM PC*	WRT\$ = "TRACE1 DESCRIPTION:L1" CALL IBWRT(RT%,WRT\$)

TABLE 3-1 (cont)
Examples of Set Commands

Command Class	Controller	Program Line
Measurement	HP 200, 300	OUTPUT @Rt;"MSLIST PER,FRE"
	IBM PC*	WRT\$ = "MSLIST PER,FRE" CALL IBWRT(RT%,WRT\$)
Data Transfer	HP 200, 300	OUTPUT @Rt;"ENCDG WAVFR:ASCII"
	IBM PC*	WRT\$ = "ENCDG WAVFR:ASCII" CALL IBWRT(RT%,WRT\$)
Status	HP 200, 300	OUTPUT @Rt;"RQS ON"
	IBM PC*	WRT\$ = "RQS ON" CALL IBWRT(RT%,WRT\$)

*IBM PC with a National Instruments GPIB interface card.

Responses From The Oscilloscope

Table 3-2 lists typical 11301/11302 queries and responses as they would appear in an HP BASIC or IBM BASICA application program for the GPIB. In the following examples, it is assumed that "@Rt" and "RT%" have been assigned address values that identify them with the 11301/11302. The response is printed to the controller display. The query response messages are in bold.

NOTE

Error and warning messages compose a special class of responses and may be sent to a controller via the EVENT? command. See the errors and events handling information, and the special RS-232-C I/O Considerations discussions in this section.

TABLE 3-2
Examples of Queries

Command Class	Controller	Program Lines and Responses
Channel	HP 200, 300	<pre>DIM Resp\$(100) OUTPUT @Rt;"CHL1?SENSITIVITY" ENTER @Rt;Resp\$ PRINT Resp\$</pre> <p>CHL1 SENSITIVITY:1.00</p>
	IBM PC*	<pre>WRT\$ = "CHL1?SENSITIVITY" CALL IBWRT (ET%,WRT\$) RD\$=SPACE\$(100) CALL IBRD (ET%,RD\$) PRINT RD\$</pre> <p>CHL1 SENSITIVITY:1.00</p>
Time base	HP 200, 300	<pre>DIM Resp\$(100) OUTPUT @Rt;"TBMAIN? TIME" ENTER @Rt;Resp\$ PRINT Resp\$</pre> <p>TBMAIN TIME:5.00E6, MAGNIFIER:OFF, POSITION:1.2</p>
	IBM PC*	<pre>WRT\$ = "TBMAIN? TIME" CALL IBWRT (RT%,WRT\$) RD\$=SPACE\$(100) CALL IBRD (RT%,RD\$) PRINT RD\$</pre> <p>TBMAIN TIME:5.00E-6, MAGNIFIER:OFF, POSITION:1.2</p>

* IBM PC with a National Instruments GPIB interface card.

TABLE 3-2 (cont)
Examples of Queries

Command Class	Controller	Program Lines and Responses
Waveform	HP 200, 300	<pre>DIM Resp\$[100] OUTPUT @Rt;"TRACE1? DESCRIPTION" ENTER @Rt;Resp\$ PRINT Resp\$</pre> <p>TRACE1 DESCRIPTION:L1, VPOSITION:0,HPOSITION:0,UNIT:"V"</p>
	IBM PC*	<pre>WRT\$ = "TRACE1? DESCRIPTION?" CALL IBWRT (RT%,WRT\$) RD\$=SPACE\$(100) CALL IBRD (RT%,RD\$) PRINT RD\$</pre> <p>TRACE1 DESCRIPTION:L1, VPOSITION:0,HPOSITION:0,UNIT:"V"</p>
Measurement	HP 200, 300	<pre>DIM Resp\$[100] OUTPUT @Rt;"MEAS?" ENTER @Rt;Resp\$ PRINT Resp\$</pre> <p>MEAS TIME:"12:07:05", DATE:"16 JUL 87",FREQ:6.1E6</p>
	IBM PC*	<pre>WRT\$ = "MEAS?" CALL IBWRT (RT%,WRT\$) RD\$=SPACE\$(100) CALL IBRD (RT%,RD\$) PRINT RD\$</pre> <p>MEAS TIME:"12:07:05", DATE:"16 JUL 87",FREQ:6.1E6</p>

* IBM PC with a National Instruments GPIB interface card.

TABLE 3-2 (cont)
Examples of Queries

Command Class	Controller	Program Lines and Responses
Data Transfer	HP 200, 300	<pre>DIM Resp\$(100) OUTPUT @Rt;"WAVFRM?" ENTER @Rt;Resp\$ PRINT Resp\$</pre> <p>WFMPRE WFID:ST01, ENCDG:ASCII, NR.PT:1024, PT.FMT:Y, XMULT:1.0, XINCR:10E-3, XZERO:0, XUNIT:"s", YMULT:1.00, YZERO:0, YUNIT:"v"</p>
	IBM PC*	<pre>WRT\$ = "WAVFRM?" CALL IBWRT (RT%,WRT\$) IBCNT% = 240 WHILE IBCNT% = 240 RD\$=SPACE\$(240) CALL IBRD (RT%,RD\$) PRINT RD\$ WEND</pre> <p>WFMPRE WFID:ST01, ENCDG:ASCII, NR.PT:1024, PT.FMT:Y, XMULT:1.0, XINCR:1E2, XZERO:0, XUNIT:"s", YMULT:1.00, YZERO:0, YUNIT:"v"</p>
Status and Events	HP 200, 300	<pre>DIM Resp\$(100) OUTPUT @Rt;"EVENT?" ENTER @Rt;Resp\$ PRINT Resp\$</pre> <p>EVENT 400, "No status to report"</p>
	IBM PC*	<pre>WRT\$ = "EVENT?" CALL IBWRT (RT%,WRT\$) RD\$=SPACE\$(100) CALL IBRD (RT%,RD\$) PRINT RD\$</pre> <p>EVENT 400, "No status to report"</p>

* IBM PC with a National Instruments GPIB interface card.

Data Transfer Examples

Two examples of making a measurement and receiving the results are described in Figure 3-10. One is for the GPIB interface and one for the RS-232 interface. These examples assume that the oscilloscope is already set up for the intended data to be transferred, and that the GPIB controller and RS-232 interface software are properly configured.

The interface menu settings for these examples are as shown previously in Figure 3-7 and Figure 3-8.

```
GPIB:

10  DIM SETTING$(7000)
20  ASSIGN @RT TO 701
30  OUTPUT @RT;"SET?",END
40  ENTER @RT;SETTING$
50  PRINT SETTING$
60  END

RS-232-C:

10  DIM SETTING$(7000)
20  CONTROL 9,3;9600
30  CONTROL 9,4;3+0+8+16
40  ASSIGN @RT TO 9
50  OUTPUT @RT;"SET?"
60  ENTER @RT;SETTING$
70  PRINT SETTING$
80  END
```

6106-360

Figure 3-10. Setting Retrieval Example Programs for HP 200/300 Series.
(In the GPIB example, "RT" is the 11301/11302 address plus 700.)

Command Set

This information describes the various command usage and processing conventions, followed by the 11301/11302 command set.

Command Usage Conventions

The ASCII command set information includes syntax and semantic descriptions for all commands. In this context, an "ASCII command" is a data stream received at the oscilloscope's GPIB or full-duplex RS-232-C port.

The commands and syntax comply with the Tektronix GPIB Codes, Formats, Conventions, And Features Standard. For details of this standard, contact your local Tektronix Field Representative.

Syntax Conventions

There are a number of syntax conventions used throughout the section. The principal convention is the extended BNF (Backus-Naur-Form) notation.

The extended BNF symbols used in this section are:

- < > Defined Element
- ::= Is Defined As
- { } Grouping
- [] Optional, May Be Omitted
- | Exclusive OR
- ... Previous Element May Be Repeated One Or More Times

Globally defined elements are:

- <block> ::= Tektronix Codes & Formats standard binary block data (including modulo 256 checksum). See the CURVE command in the command set for the binary block format.
- <EOI> ::= End Of Input delimiter. This delimiter terminates a message transmitted to or from the oscilloscope.
- <slot> ::= {L | C | R}. Respectively designates a Left, Center, or Right plug-in compartment. (Corresponding lower case letters may also be used.)

Numeric Arguments:

- <NRx> ::= {<NR1> | <NR2> | <NR3>}. Valid range: $1e-300 < \text{abs}(X) < 1e+300$, 15 significant digits max. All three forms have optional signs.
- <NR1> ::= this is a signed integer value.
- <NR2> ::= this is a floating point value without an exponent.
- <NR3> ::= this is a floating point value with an integer exponent.
- <ui> ::= unsigned integer value; no leading white space permitted unless otherwise noted.

In general, any out-of-range number (except <ui>) sent to the instrument is coerced into range by setting it to the nearest acceptable value. Commands that only accept a small number of integral values do not coerce their arguments.

Quoted Strings:

- <qstring> ::= quoted string data. This element may optionally contain "escaped" data, which provides access to special graphics characters (see Table 3-19, Escaped Character Set).
- <q5 string> ::= quoted string limited to five characters. There are many lexical features associated with quoted string data:
- Unless otherwise noted in this document (and excepting a q5 string), the maximum length of any quoted string is 512 characters, excluding delimiters.
 - Quoted string data returned to the ASCII ports (i.e., query data) is delimited with quotation marks.
 - A delimiter may be included within a string by repeating the delimiter. For example, to display a quote within the "quoted string", two quotes are needed.

Text string: "double "" quote" is displayed as:

double " quote

- A quoted string must be terminated with a quotation mark ("), and cannot be terminated with an IEEE-488 EOI interface signal. Thus, an EOI cannot be used as a termination. A line feed and carriage return are considered ordinary characters in the string.

- A quoted string may not include an embedded ASCII NULL character CHR\$(0), or 00H unless it is preceded by an escape character, CHR\$(27).
- Special characters, listed in Table 3-9, are accessed by using ESCAPE followed by the standard character found in Table 3-8. For example, to display the character for the upper-case greek letter delta, construct a string that contains CHR\$(27), immediately followed by CHR\$(68), or followed by the character "D".

Command Structures

The ASCII commands are divided into two categories: set commands, which specify an action to be taken, and queries, which return a specified state of the device.

Set Commands

Set commands come in three types: set commands with link arguments, set commands without link arguments, and set commands that have a mix of link and nonlink arguments.

Set Commands With Link Arguments

The syntax of a set command with link arguments is

```

<SET WITH LINK> ::= <HDR> <DLM> <LINK ARG>
<LINK ARG> ::= <LINK> : <ARG> [{, <LINK ARG>}...]
<DLM> ::= {ASCII space...} | {,}
<HDR> ::= command header
<LINK> ::= command link
<ARG> ::= link argument

```

The ENCDG command is an example of a set command that takes link arguments. The syntax elements of the ENCDG command are

Header	Link	Argument
ENCDG	WAVFRM SET	ASCII BINARY ASCII BINARY

Thus, the following ENCDG set commands are possible (this is not a complete list):

```

ENCDG WAVFRM: BINARY<EOI>
ENCDG SET: ASCII, WAVFRM: ASCII<EOI>
ENCDG WAVFRM: ASCII, SET: ASCII<EOI>

```

Note that links may follow a command header in any order.

Set Commands Without Link Arguments

The syntax of a set command without link arguments is

```

<SET NO LINK> ::= <HDR> <DLM> <ARG> [{, <ARG>}...]
<DLM>        ::= {ASCII space...} | {,}
<HDR>        ::= command header
<ARG>        ::= argument
    
```

The RQS command is an example of a set command that takes no link (nonlink) arguments. The syntax elements of the RQS command appear as:

Header	Link	Argument
RQS		ON OFF

Thus, the following RQS set commands are possible:

```

RQS ON<EOI>
RQS OFF<EOI>
    
```

Set Commands That Mix Link and Nonlink Arguments

This class of set commands are formed by specifying a header, following it with a delimiter (space or comma), then adding comma-delimited link and nonlink arguments in any order. The SELFCAL command is an example. The syntax is

Header	Link	Argument
SELFCAL	MODE	FORCE AUTO MANUAL

Thus, the following SELFCAL set commands are possible:

```

SELFCAL FORCE<EOI>
SELFCAL MODE:MANUAL, FORCE<EOI>
    
```

Queries

In many instances, queries are formed from set commands by appending a question mark (?) to the desired set header and omitting the set command argument. However, some queries have no corresponding set commands. Such queries are referred to as "query-only."

The general syntax of a query is

```

<QUERY> ::= <HDR>? [<DLM> <LINK> [{, <LINK>}...]]
<DLM>   ::= {ASCII space...} | {,}
<HDR>   ::= query header
<LINK>  ::= query link
    
```

Queries Derived From Set Commands With Links

To form a query from a set command that takes link arguments, omit the link colon (':') and trailing argument. For example, here is a possible list of queries for the ENCDG command (this is not a complete list):

Query Sent To The Oscilloscope	Example Query Response
ENCDG? SET<EOI>	ENCDG SET: BINARY<EOI>
ENCDG? SET, WAVFRM<EOI>	ENCDG SET: ASCII, WAVFRM: ASCII<EOI>
ENCDG? WAVFRM, SET<EOI>	ENCDG WAVFRM: BINARY, SET: ASCII<EOI>

Note that query links may follow a query header in any order.

When query links are omitted (i.e., the command is simply a query header), all links and the current argument for each is returned. For example:

Query Sent To The Oscilloscope	Example Query Response
ENCDG?<EOI>	ENCDG WAVFRM: ASCII, SET: ASCII<EOI>

Queries Derived From Set Commands Without Links

To form a query from a set command that takes no link arguments, omit the set command argument. For example, there is only one possible query for the RQS set command:

Query Sent To The Oscilloscope	Example Query Response
RQS?<EOI>	RQS OFF<EOI>

Queries Without Corresponding Set Commands

If a query has no corresponding set command, its syntax is fully specified and explained in this manual. An example of such a query is the UPTIME query (syntax: "UPTIME?").

NOTE

Except for HELP?, the response obtained from a query with no corresponding set command can be returned to the oscilloscope as a command string. If the command string is otherwise syntactically correct, it is ignored.

Also, attempting to query a Set Only command (one with no valid query form) can result in execution of the command followed by a syntax error. This will occur if the command is valid up to the question mark. For example, INIT? will be interpreted as INIT (a valid set command) followed by ? (an invalid command).

Command Processing Conventions

The following text describes conventions for processing commands:

- Several set commands cannot be queried. These commands are referred to as "set-only" and are clearly identified in this section.

NOTE

Attempting to query a set-only command always results in a syntax error.

- Command links called "query only" cannot be modified. All such links are clearly identified in this section.

NOTE

Attempting to modify a query-only link argument (via set command) is not considered to be an error if the link argument is syntactically valid. The oscilloscope simply ignores the attempted modification. This convention permits query responses that include query-only links to return to the oscilloscope without generating a syntax error.

- The oscilloscope recognizes alphabetic character input of either upper or lower case. Thus, it considers the commands "Rqs On" and "rqs ON" to be identical. The oscilloscope returns only UPPERCASE alphabetic data to the ASCII ports.
- Any command reserved word transmitted to the oscilloscope may be abbreviated up to the minimum ambiguity as described under "Abbreviating Command Set Words" found later in this section.
- Any combination of set or query commands may be concatenated together with a semicolon. Thus:

```
RQS OFF<EOI>      ENCDG? <EOI>      UPTIME?<EOI>
```

may be combined as

```
RQS OFF;ENCDG?;UPTIME?<EOI>
```

- The response to command input containing more than one query is formatted with the response to the first query returned first.

```
<response>;<response>[;<response>...]<EOI>
```

Thus, for the command "RQS ON;RQS?;DT OFF;DT?<EOI>", the query response is

```
RQS ON;DT OFF<EOI>
```

- Any command element (i.e., a <HDR>, <LINK>, <ARG>, comma, or colon) received at an oscilloscope ASCII port can be preceded by white space.
- At either port, characters 1...32 are white space, unless a character is selected as a terminator. Even if the character is a terminator between commands or before the header, the character is accepted as white space and ignored.
- At the RS-232-C port, white space is any blank, " ", or any character in the range CHR\$(1)...CHR\$(31), if the character is not selected as a terminator.
- When the GPIB port is configured for IEEE-488 EOI command termination, white space is any combination of blanks or characters in the range CHR\$(1)...CHR\$(31).
- When the GPIB port is configured for linefeed command termination, white space is any combination of spaces or carriage returns.

As an example, the first command is equivalent to the second command:

1. ENCDG WAFIRM : ASCII , SET: BINARY <EOI>
2. ENCDG WAFIRM:ASCII,SET:BNARY<EOI>

- The oscilloscope unconditionally clears its GPIB output buffer when any new input command (set or query) appears at the GPIB port (no error is reported). This action is not taken at the RS-232-C port. A new GPIB input command is a command that arrives after a previously received <EOI>. Thus, the GPIB interface must be talked after one or more queries and an <EOI> or the response is lost.
- The oscilloscope unconditionally clears its GPIB output buffer when both the GPIB input and output buffers are simultaneously full. An execution error SRQ is also reported (event code 203—I/O buffers full).
- Except for the STBYTE? query (not a valid GPIB command), all commands listed in this document are valid for use at both the GPIB and RS-232-C ports.
- All commands are port-independent, except EVENT?, ALLEV?, STBYTE?, RQS, and SRQMASK. A port-dependent command modifies or queries data that is not shared between the I/O ports of the oscilloscope. Port-independent commands modify or query data shared between I/O ports.

Plug-In Slot Designators

The letters "L" (left), "C" (center), and "R" (right) designate the addressed plug-in compartment. For instance, in the command that follows, the "L" after CH indicates that a channel of the left plug-in unit is accessed. The number "1" is the channel to be set for a vertical offset of 4.

```
CHL1 OFFSET:4
```

Talked With Nothing To Say (TWNTS)

If the 11301/11302 GPIB port is talked with the input and output buffers empty while the oscilloscope is not currently processing a GPIB command, the oscilloscope returns a "TWNTS" message to the GPIB port. The message is simply one byte with all eight bits set, followed by <EOI> (e.g., FF<EOI>, or CHR\$(255)).

The RS-232-C interface does not have a "TWNTS" message. So, if an external device attempts to read data from the 11301/11302 RS-232-C port while the oscilloscope has no pending query responses or buffered query responses to process that device waits indefinitely.

ASCII Interface Operating Conventions

The oscilloscope follows a number of conventions in dealing with interface operations for processing data and performing related operating functions.

**User Interfaces:
I/O Synchronization** If the mainframe front panel, GPIB port, and RS-232-C port are set to be simultaneously active (i.e., engaged in I/O), the sequence of events is up to the user. The oscilloscope does not synchronize the order in which GPIB commands, RS-232-C commands, or human interface commands are executed.

However, the oscilloscope "tags" all input messages with the identity of the originating entity (GPIB, RS-232-C, or front panel) and correctly returns command queries and SRQ's as appropriate. For example, assume the RS-232-C sends a "HELP?" query to the mainframe at the same time that the GPIB sends an "UPTIME?" query. In this scenario, only the RS-232-C will receive a response for the HELP? query and only the GPIB will receive a response for the UPTIME? query. However, the port that receives its query response first (in this "race" condition) cannot be determined.

GPIB Remote/Local Conventions

With one exception, the oscilloscope complies with the requirements noted in the IEEE-488 standard for the RL1 Remote/Local interface function. The exception is that the oscilloscope executes all GPIB commands and queries regardless of the remote/local state.

This oscilloscope observes the following conventions with respect to the GPIB RL interface function:

When the oscilloscope is in either LOCS (local state) or LWLS (local with lockout state), all front-panel controls are operable.

When the oscilloscope is in REMS (remote state), all front-panel controls are also operable, since activation of any front-panel control generates an "rtl" signal that moves the RL state diagram to LOCS before a particular activation is acknowledged.

When the oscilloscope is in RWLS (remote with lockout state), only the following front-panel controls are operable:

1. Front-panel RQS button, providing it has been enabled (the oscilloscope powers up with the button disabled). The RQS button is enabled/disabled only via ASCII interface commands. The commands necessary to enable the RQS are:

```
RQS ON;SRQMASK USER:ON
```

Once enabled, front-panel RQS can be disabled with either of the following commands:

```
RQS OFF
or
SRQMASK USER:OFF
```

2. Plug-in probe ID button presses (when available). In lockout state, the only effect produced by a probe ID button press is to return a system event status byte.

There is no remote/local function implemented for the RS-232-C. Also, the GPIB RL state has no impact on the function or response of the RS-232-C interface.

NOTE

The FPANEL device-dependent command may be used to implement GPIB RL remote with lockout over the RS-232-C.

I/O Buffers

The lengths of the GPIB/RS-232-C input and output buffers are shown in Table 3-3.

**TABLE 3-3
I/O Buffer Sizes**

GPIB INPUT	GPIB OUTPUT	RS-232 INPUT	RS-232 OUTPUT
256	512	256	512

Should an external controller fill the GPIB/RS-232-C input buffers before the oscilloscope can process the contents, the 11301/11302 holds off the external controller (via IEEE-488 interface signals or RS-232-C flagging) until the input buffers are empty.

Similarly (with respect to GPIB/RS-232-C output buffers), if a query response fills the oscilloscope output buffers, no more data is transmitted to the output ports until an external controller clears (reads) those buffers.

DCL Conventions

The DCL (Device Clear) and SDC (Selected Device Clear) interface message requirements state that upon receipt of a DCL or SDC message, an instrument must take the following actions to restart device communications:

1. Clear any SRQ (except "power on") and all pending events (except "power on").
2. Clear input and output buffers.
3. Restart device-dependent message processing.
4. Not change any settings or stored data.
5. Not interrupt front panel I/O.
6. Not interrupt non-programmable functions.

In addition, a DCL message received from the RS-232-C port does not affect the processing of device communications on the GPIB, and vice versa.

Plug-In Types

There are two operational types of 11000-Series plug-in units, "intelligent" and "generic."

An intelligent plug-in unit has its own set of command functions controlled by the plug-in unit. (i.e., resident in the plug-in unit).

A generic plug-in unit (e.g., 11A32) is slave to the command set functions of the mainframe.

Further information on specific plug-in units can be found in the operating information section of this manual.

Special RS-232-C I/O Conventions

The following describes RS-232-C operating features.

RS-232-C Emulation Of GPIB Interface Messages

Except for DCL (device clear), the RS-232-C interface does not support GPIB interface messages. To emulate DCL, an RS-232-C device (controller, terminal, etc.) must transmit a break character to the RS-232-C port of the oscilloscope.

The interface message capabilities of the RS-232-C port, in comparison to the GPIB port, are given in Table 3-4.

**TABLE 3-4
RS-232-C & GPIB Interface Messages**

Interface Message	Implemented GPIB Port	Implemented RS-232 Port
GTL	Yes	No*
SDC	Yes	No
PPC	No	No
GET	Yes	No
TCT	No	No
LLO	Yes	No*
DCL	Yes	Yes
PPU	No	No
SPE	Yes	No
SPD	Yes	No
UNT	Yes	No
UNL	Yes	No
Talk Addresses	Yes	No
Listen Addresses	Yes	No

* The device-dependent command (FPANEL) implements this function over the RS-232-C or GPIB interface.

Binary Block
Data Transfer

When transferring binary block data to the oscilloscope via the RS-232-C:

- A carriage return (CR), linefeed (LF), CR/LF, or LF/CR terminates all ASCII input messages. However, during binary block transfers, a carriage return or linefeed is accepted as data until the block byte count is satisfied.
- Do not use binary data transfers with SOFT flagging unless the user is sure that the data has no XON or XOFF characters. Use of HARD flagging guarantees correct data transfer.
- To avoid loss of data, configure the external RS-232-C controller to receive and transmit eight-bit characters (i.e., set the RS-232-C word length to eight bits). If a controller cannot receive or transmit eight-bit characters, it also cannot exchange binary block data.

RS-232-C Echo

When echo is enabled, all characters received at the RS-232-C port are echoed back to the command source. Echo should be used under the following conditions:

- When a "dumb" RS-232-C device (e.g., a crt terminal) is connected to the RS-232-C port. Once echo is on, each character typed at the terminal is echoed back and, consequently, the device operator can see what is being typed.

- Echo should be disabled when a computer program is transmitting commands to the oscilloscope (e.g., when a BASIC program on a small computer is being used to control the oscilloscope via the RS-232-C port). The computer program will not expect to see its commands echoed back and the program may fail unless the program is designed to handle remote echo.

RS-232-C SRQ Reporting

The 11301/11302 RS-232-C service request reporting mode is selected with the "RS-232 SRQ:" command (see the RS-232-C command in the command set) from either ASCII external interface. The selections are either ASCII or BREAK:

- When ASCII is selected and LONGFORM is OFF (see the LONGFORM command), the oscilloscope sends the controller:

```
STB <NR1>
```

where <NR1> is the status byte to report the oscilloscope condition.

When ASCII is selected and LONGFORM is ON, the oscilloscope sends the controller:

```
STBYTE <NR1>
```

- When BREAK is selected, the oscilloscope sends the controller a break character. That is, the RS-232-C transmit line is held low for a time greater than the combined data and start bit periods, which the controller recognizes as an SRQ from the oscilloscope.

RS-232-C Pin Out and Cable Connections

The 11301/11302 RS-232-C port is configured for full-duplex, DCE-type communications. Half-duplex communications are not supported. The oscilloscope RS-232-C pin assignments are listed below.

Pin	Title	Oscilloscope In/Out	Comments
1	Chassis Ground		
2	Transmit Data	Input	
3	Received Data	Output	
4	Request To Send	Input	Ignored by the oscilloscope
5	Clear To Send	Output	See flagging discussion
6	Data Set Ready	Output	Always high
7	Signal Ground		
8	Data Carrier Detect	Output	Always high
20	Data Terminal Ready	Input	See flagging discussion

Connecting Two
RS-232-C Devices

Connecting two different RS-232-C devices, notably those of different manufacture, is sometimes difficult. Although it is also difficult to predict the problems to be encountered, the following might be helpful:

1. Read the instruction manual for the device you wish to connect to the 11301/11302 and determine which signal lines are ignored, which are output lines, and which are input lines. Determine also whether this device is configured as a DTE or DCE.
2. If a DTE device is being attached to the 11301/11302, probably no signal lines must be swapped between the two devices.
3. If a DCE device is being connected, at least two signal lines, Transmit Data and Receive Data, must be swapped. If hard flagging is also used in this DCE-to-DCE connection, two more signals (typically, DTR and CTS) are usually swapped (consult the device instruction manual for exact details).
4. When wiring the cable that connects the 11301/11302 to an external device:
 - a. Note the input signal requirements of the external device (many devices require a constant high signal at one or more input pins).
 - b. With respect to DCE-to-DCE connections, do not connect the output line of one DCE to the output line of the other; otherwise, one or both devices may be damaged.
 - c. Ensure that the oscilloscope signal ground is connected to the external device signal ground.
 - d. Ensure that the oscilloscope chassis ground is connected to the external device chassis ground.

Example Cable
Connections

See Figure 3-11, which shows typical cable connections used when connecting an RS-232-C device to the 11301/11302.

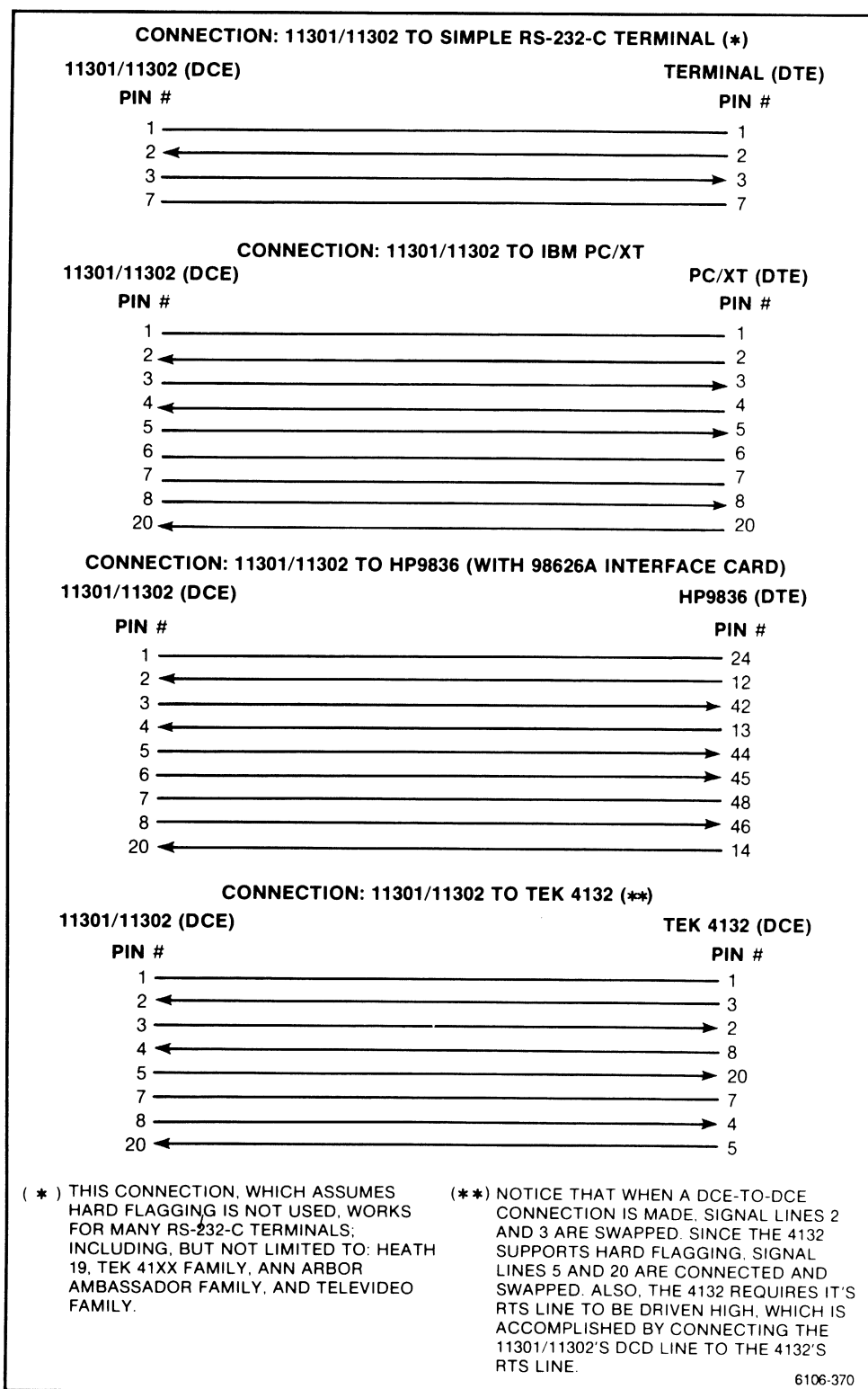

Figure 3-11. Examples of RS-232-C Connections.

Syntax and Descriptions

The ASCII Interface command set for the 11301/11302 is divided into classes of similar functions. For each grouping, the headers with all links and arguments are listed first (i.e., syntax). Then each header with links and arguments is described. This is followed by a description of each command query form (if appropriate) and the responses. Finally, any general information (e.g., error and warning conditions) about the commands is described.

For many commands and links, detailed definitions and descriptions of corresponding front-panel functions can be found in the (front-panel) operating information section of this manual.

Autoset Commands

TABLE 3-5
Autoset Commands

Header	Link	Argument
AUTOSET	TIME AMPLITUDE START	ON OFF ON OFF ALL CH<compartment><ui>[,{CH<compartment><ui>...}] TRACE<ui>[,{TRACE<ui>...}] SELECT (set only)

AUTOSET Command

This command determines all parameters of the Autoset function and initiates execution.

Parameters:

TIME—enables or disables the automatic scaling of the time base for the selected waveform.

AMPLITUDE—enables or disables the automatic scaling of the amplifiers for the selected waveform.

START—enables the automatic scaling of plug-in channels or traces. **AUTOSET START:ALL** will initiate the scaling of all defined traces.

Query Information The general query form for AUTOSET? returns all links and their current arguments, in the form:

```
AUTOSET <link>:<arg>[{,<link>:<arg>}...]
```

Individual links can be queried.

Examples of queries and related responses follow:

```
AUTOSET?
```

```
AUTOSET TIME:ON,AMPLITUDE:ON
```

Channel Commands

Channel commands set or query the parameters of an 11000-series vertical channel plug-in unit. See Table 3-6.

TABLE 3-6
Channel Commands

Header	Link	Argument
CH<compartment><ui>	COUPLING	AC DC OFF
	PLSCOUPLING	AC DC VC OFF
	MNSCOUPLING	AC DC VC OFF
	OFFSET	<NRx>
	PLSOFFSET	<NRx>
	MNSOFFSET	<NRx>
	VCOFFSET	<NRx>
	AMPOFFSET	<NRx>
	BWHI	<NRx>
	BWLO	<NRx>
	IMPEDANCE	<NRx>
	SENSITIVITY	<NRx>
	UNITS	<qstring> (query only)
	PROBE	<qstring> (query only)

CH<compartment><ui> Command

The <compartment> component of this command header selects a particular plug-in compartment (L, C, or R), and the <ui> header component selects a particular plug-in channel (1, 2, 3, or 4). Thus, to set or query any parameter of the third channel of the LEFT vertical plug-in amplifier, the command header must appear as CHL3.

Parameters:

COUPLING—sets the selected channel input coupling to the selected argument. This parameter is not used by differential amplifiers.

PLSCOUPLING—sets the selected channel (+) differential input to the selected argument. This parameter is used only by differential amplifiers.

MNSCOUPLING—sets the selected channel (–) differential input to the selected argument. This parameter is used only by differential amplifiers.

OFFSET—sets the specified channel to the amount of offset indicated by the argument. The units depend upon the plug-in. The range available depends on the plug-in.

PLSOFFSET—refer to Plug-in Supplement.

MNSOFFSET—refer to Plug-in Supplement.

VCOFFSET—refer to Plug-in Supplement.

AMPOFFSET—refer to Plug-in Supplement.

BWHI—sets the specified channel upper bandwidth to the value indicated by the argument. The implied units are Hz (hertz). The range available depends on the plug-in.

BWLO—sets the specified channel lower bandwidth to the value indicated by the argument. The implied units are Hz (hertz). The range available depends on the plug-in.

IMPEDANCE—sets the specified channel input impedance to the value indicated by the argument. Implied units are ohms.

SENSITIVITY—sets the specified channel vertical input sensitivity to the setting indicated by the argument.

NOTE

This is a channel-specific command and not applicable to compound waveforms. The range of values available and the units range depends upon the plug-in.

Query Information

The general query form is

CH[<compartment>[<ui>]]?

Note that both the compartment and channel designators are optional. Thus there are four forms of the query, each with a different response:

CH?

CH<compartment>?

CH<compartment><ui>?

CH[<compartment>[<ui>]?]<link>[{,<link>}...]

The first form,

CH?

returns all possible responses.

The second form

CH<compartment>?

returns only a subset response that pertains to the indicated compartment.

The third form

CH<compartment><ui>?

returns only a subset response that pertains to both the indicated compartment and channel.

The fourth form

CH[<compartment>[<ui>]]?<link>[,{<link>}...]

returns only a subset response that pertains to the indicated compartment, channel, and link(s). If no channel is specified, information for all channels in the compartment is returned. If neither a compartment nor a channel is specified, information is returned for all compartments and all channels.

In response to the query:

CH?<link>,<link>

If a compartment does support a link, the information is returned for all that do. If no compartment supports the link, a command error is reported.

The CH<compartment><ui>?PROBE query returns a string stating the probe current in use. The argument returned for a probe link is a <q5 string>.

The CH<compartment><ui>?UNITS query returns a <q5 string>, indicating the units of the selected channel and the selected channel (e.g. CHL1). This information may be different from the response to the TRACE<ui>? query (a trace can have different units than one of its components). Query responses for all links with numerical arguments are of type <NR3>.

An example of a query and related response follows:

CHL1?

```
CHL1 COUPLING:DC, SENSITIVITY:1.00, OFFSET:0, BWHI:
300.E+6, IMPEDANCE:1.00E+6, UNITS:"V"
```

General Information

Commands to nonexistent plug-ins, installed plug-ins that do not support the stated channel, or installed plug-ins that do not support the function specified by the link all cause command error reports.

Out-of-range arguments set the link value to the appropriate range limit and execution warnings are issued. Refer to your plug-in unit manual to determine which functions are supported.

Counter/Timer Commands

The commands shown in Table 3-7 are used to program the counter/timer function.

TABLE 3-7
Counter/Timer Commands

Header	Link	Argument	Range
CTRESET (set only)			
CTMEAS		FREQUENCY PERIOD WIDTH TOTAL RATIO TIME OFF	
CTRESULT? (query only)			
CTFREQUENCY CTPERIOD CTWIDTH	AVERAGES GATING UPDATE SOURCE REFERENCE	<NRx>* DLY1 BEXT ABEXT OFF MANUAL AUTO MAINTRIG DLY1TRIG DLY2TRIG AEXT <NRx>	0 to 1E10
CTTOTAL	GATING UPDATE SOURCE	DLY1 BEXT ABEXT OFF START STOP MDTRIG ABEXT AEXT MAINTRIG	
CTRATIO	AVERAGES GATING UPDATE SOURCE REFERENCE	<NRx>* DLY1 BEXT ABEXT OFF MANUAL AUTO MDTRIG ABEXT MBEXT <NRx>	0 to 1E10
CTTIME	AVERAGES UPDATE SOURCE REFERENCE	<NRx>* MANUAL AUT SWPSTART ABEXT MDTRIG <NRx>	0 to 1E10
CTCLOCK		INTERNAL EXT10MHZ	

*When averaging, the ranges in Table 3-8 apply.

TABLE 3-8
NRx Argument Ranges

NRx Argument Range	Number of Averages
less than 1	(auto)
1 to <5E1	1
5E1 to <1E3	1E2
1E3 to <1E5	1E4
1E5 to <1E7	1E6
1E7 to <1E9	1E8
1E9 or greater	1E10

NOTE

The following defined configurations do not interact with each other. Only one configuration is used at a time. Selecting the measurement determines which configuration is used.

CTRESET Command

This command restarts the measurement, regardless of the current configuration of the counter/timer.

CTMEAS Command

This command selects the kind of measurement the counter/timer is to make. See the Operating Information section for a description of the waveform measurements made by the counter-timer. The OFF argument turns off the counter-timer measurement function, removing the results from the display.

CTRESULT? Query Command

This query-only command returns the value of the currently selected measurement and its reference. To ensure that the latest measurement of FREQUENCY, PERIOD, WIDTH, RATIO, or TIME A→B is available, this query should be performed after receipt of the Operation Complete SRQ (Status Byte 66) and Event Code 468. For Total, there is no "complete" state as it is always accumulating. To ensure the latest Total, always set UPDATE to STOP prior to querying for TOTAL results.

CTFREQUENCY, CTPERIOD, CTWIDTH, CTTOTAL, CTRATIO, and CTTIME Commands.

NOTE

The following commands share many similar parameters. Hence, similar parameters are described only once.

CTFREQUENCY—is used to define the desired configuration for making frequency measurements even if frequency is not the currently selected measurement.

CTPERIOD—is used to define the desired configuration for making period measurements even if period is not the currently selected measurement.

CTWIDTH—is used to define the desired configuration for making width measurements even if width is not the currently selected measurement.

CTTOTAL—is used to define the desired configuration for making total measurements even if total is not the currently selected measurement.

CTRATIO—is used to define the desired configuration for making ratio measurements even if ratio is not the currently selected measurement.

CTTIME—is used to define the desired configuration for making time measurements even if time is not the currently selected measurement.

Parameters:

AVERAGES—selects the number of measurement passes to be used in calculating the average value of the selected measurement.

GATING—selects the source of measurement gating or disables gating.

UPDATE—selects the manner in which a measurement is updated, except for the CTTOTAL command. For CTTOTAL, the updating of measurements is enabled or disabled.

SOURCE—selects the source of signal for the measurement.

REFERENCE—sets a value which acts as a reference for the measurement. All results represent the relative difference between the measurement and reference values.

CTCLOCK Command

This command selects the internal or external clock (bnc provided) for the counter/timer.

Query Information CTRESULT? returns the values of the currently selected measurement in the form:

```
CTRESULT <link1>:<NRx>,<link2>:<NRx>
```

where

<link1>	<link2>
OFF	REF
FREQUENCY	REF
PERIOD	REF
WIDTH	REF
RATIO	REF
TIME	REF
MTOTAL	D1TOTAL
ATOTAL	BTOTAL

If CTMEAS is set to OFF, CTRESULT? will return:

```
CTRESULT OFF:0,REF:0
```

CTRESULT?<link> is treated as if no link is specified.

All other commands (except for CTRESET) are queried in the usual manner. If links are not specified, all link/arguments for the header are returned. For example, CTFREQUENCY? would be returned:

```
CTFREQUENCY AVERAGES:<NR3>,UPDATE:<arg>,GATING:<arg>,
SOURCE:<arg>,REFERENCE:<arg>
```

Examples of queries and related responses follow:

```
CTMEAS?
```

```
CTMEAS FREQUENCY
```

```
CTRESULT?
```

```
CTRESULT FREQUENCY:128.421,REFERENCE:0
```

```
CTFREQUENCY?
```

```
CTFREQUENCY AVERAGES:0,GATING:OFF,
UPDATE:MANUAL,SOURCE:MAINTRIG,REFERENCE:0
```

CTPERIOD?

CTPERIOD AVERAGES : 0 , GATING : OFF , UPDATE : AUTO ,
SOURCE : MAINTRIG , REFERENCE : 0

CTWIDTH?

CTWIDTH AVERAGES : 0 , GATING : OFF , UPDATE : AUTO ,
SOURCE : MAINTRIG , REFERENCE : 0

CTTOTAL?

CTTOTAL GATING : OFF , UPDATE : STOP , SOURCE : MDTRIG

CTRATIO?

CTRATIO AVERAGES : 0 , GATING : OFF , UPDATE : AUTO ,
SOURCE : MDTRIG , REFERENCE : 0

CTTIME?

CTTIME AVERAGES : 0 , UPDATE : AUTO , SOURCE : SWPSTART ,
REFERENCE : 0

CTCLOCK?

CTCLOCK INTERNAL

**General
Information**

All commands that use the AVERAGES link have a limited set of values for the <NRx> argument. This set is:

{0, 1, 1E2, 1E4, 1E6, 1E8, 1E10}

See Table 3-8 for the range of values.

In the above set, zero (0) represents AUTO, where the number of averages is decided by a time interval rather than a count.

Incorrect or out-of-range values default to the next closest number, as listed in Table 3-8.

If CTMEAS is set to OFF, the counter/timer readout line on the display is inactive for all counter/timer functions. If CTMEAS is set to any other argument, the readout line displays the current counter/timer results even if the Counter major menu is not on the display.

The REFERENCE link provides a reference value that is subtracted from the reported measurement.

An "operation complete" SRQ is issued each time a new measurement result is available providing that the OPCMPL mask is enabled. The "busy" bit is asserted while the measurement is being performed. See SRQMASK, RQS, and status commands.

Cursor Commands

The commands shown in Table 3-9 are used to create and position the calipers and to qualify the mode of operation.

TABLE 3-9
Cursor Commands

Header	Link	Argument	Range	Resolution
CURSOR		HORIZONTAL VERTICAL OFF		
VCURSOR	REFERENCE SCALE TRACKING	<NRx> RELATIVE ABSOLUTE ON OFF	0 to 8	0.01
HCURSOR	REFERENCE SCALE TRACKING	<NRx> RELATIVE ABSOLUTE ON OFF	0 to 10	0.01
H1ABS H2ABS V1ABS V2ABS V1REL V2REL H1REL H2REL	DIV	(set only) (set only) (set only) <NRx> (set only) <NRx>	Horiz -5 to +5 Vert -4 to +4	0.01 0.01
VREF? HREF?	COORD UNITS	<NRx> (query only) <q5 string> (query only)		
VDELTA?	DB PERCENT DIV COORD UNITS	<NRx> (query only) <NRx> (query only) <NRx> (query only) <NRx> (query only) <q5 string> (query only)		
HDELTA?	DEGREES PERCENT DIV COORD UNITS DB	<NRx> (query only) <NRx> (query only) <NRx> (query only) <NRx> (query only) <q5 string> (query only) <NRx> (query only; xy traces only)		

CURSOR Command

This command displays the actual cursor lines on the crt, vertical or horizontal. The argument refers to the dimension to be measured, not the calipers themselves.

To assign the knobs to control the cursors, the ABSTOUCH command must be used (ABSTOUCH 1,17).

VCURSOR & HCURSOR Commands

VCURSOR controls the behavior and scaling of the vertical cursors, while HCURSOR controls the behavior and scaling of the horizontal cursors.

Parameters:

SCALE—For vertical calipers, this command selects absolute and delta measurements (ABSOLUTE) or relative percent and dB measurements (RELATIVE). For horizontal calipers, this command selects either absolute and delta measurements (ABSOLUTE) or relative percent and degree (RELATIVE) measurements or relative percent and dB measurements (XY traces only).

REFERENCE—Sets the reference delta (in divisions) that marks 100% (0 dB vertical and horizontal for XY traces; and 360° horizontal for YT traces) for relative cursor readout. The argument must be nonzero, because this value is used as a divisor.

TRACKING—If a particular cursor pair has been assigned to the knobs, this parameter determines how they move when the left knob is turned. When the cursors are set for TRACKING:OFF, solid cursors follow the left knob and dashed cursor follows the right knob. When the cursors are set for TRACKING:ON, the left knob controls the position of both cursors, while maintaining a constant displacement. At the same time, the right knob controls the dashed cursor alone, and is used to change the displacement.

V1ABS & V2ABS and H1ABS & H2ABS Commands

Parameters:

DIV—moves the cursor with regard to divisions on the graticule. An absolute DIV setting of zero (0) is center graticule. Positive is above center for vertical and right of center for the horizontal. These cursor positioning commands are NOT affected by the TRACKING command.

V1REL & V2REL and H1REL & H2REL Commands

Parameters:

DIV—moves the caliper relative to its present position. These cursor commands are NOT affected by the TRACKING command.

VREF? & HREF? Query Commands

These query-only commands report the vertical or horizontal reference values.

- Parameters:**
- COORD**—reports the scaled value of the amplitude reference cursor (solid line). For vertical cursors, this is referenced to zero (ground). For horizontal cursors while on an XY trace, this is also referenced to zero (ground).
- UNITS**—this query-only command reports dimensions for the associated COORD scaling (e.g., V, s, etc.).

VDELTA? & HDELTA? Query Commands

These query-only commands report the vertical or horizontal difference between cursors.

- Parameters:**
- PERCENT**—this query-only link reports the displacement given in percent, relative to the displacement given by the VCURSOR or HCURSOR REFERENCE link.

$$\text{PERCENT} = 100 \left| \frac{\text{Displacement}}{\text{REFERENCE}} \right|$$

DIV—reports the cursor with regard to divisions on the graticule. An absolute DIV setting of zero (0) is center graticule.

COORD—query-only link; reports the displacement scaled by the deflection factor. The actual dimension (V, s) is extracted by using the UNITS link.

$$\text{COORD} = (\text{displacement}) (\text{vertical scale factor})$$

DB—query-only link; reports the displacement scaled in dB.

$$\text{DB} = 20 \log \left| \frac{\text{displacement}}{\text{REFERENCE}} \right|$$

DEGREE—query-only link; reports the displacement scaled in degrees.

$$\text{DEGREE} = 360 \left| \frac{\text{displacement}}{\text{REFERENCE}} \right|$$

UNITS—this query-only command reports dimensions for the associated COORD scaling. This is returned as a five-character or less quoted string.

Query Information

The general form `CURSOR?` or `VCURSOR?`, etc. returns all links and the respective value with each. Query links can be individually specified. The user can query the current units of the vertical scaling using the query-only link `UNITS` (e.g., `VREF? UNITS`), which returns a <q5 string> character string. All others return an <NR3> number. Query links can be individually specified.

Examples of queries and related responses follow:

`HCURSOR?`

```
HCURSOR SCALE:ABSOLUTE, REFERENCE:5.00,  
TRACKING:OFF
```

`VCURSOR?`

```
VCURSOR SCALE:ABSOLUTE, REFERENCE:5.00,  
TRACKING:OFF
```

General Information

Note that each cursor has both an absolute and relative command header. Absolute positioning moves the cursor to a specific known position on the crt. Relative positioning moves the cursor to an undetermined position on the crt, based upon a displacement from its current position. "Position" means position (relative to the graticule lines).

Note that the cursors are used in making many types of measurements (e.g., rise-time or time-period measurements). See Section 2, Operating Information, "Measurements", for instructions on using cursors to make measurements.

Out-of-range values set the cursors to their extreme settings. Execution errors are not issued.

It is possible for the Cursors to yield \pm infinity. An ASCII representation of the IEEE's "-Infinity" definition is returned as `-1.0E308`. Minus infinity is only possible when querying the DB link for `HDELTA` or `VDELTA`. This occurs if the displacement between the two cursors is zero.

Data Transfer Commands

The commands shown in Table 3-10 control the transfer of digitized waveforms to and from memory across the external ASCII interfaces.

TABLE 3-10
Data Transfer Commands

Header	Link	Argument
WFMPRE	WFID ENCDG NR.PT PT.FMT XMULT XINCR XZERO XUNIT YMULT YZERO YUNIT BYT/NR BN.FMT BIT/NR CRVCHK	STO1 STO2 (query only) ASCII BINARY (query only) <NRx> Y (query only) <NRx> <NRx> <NRx> <q5 string> <NRx> <NRx> <q5 string> 2 (query only) RI (query only) 10 (query only) CHKSM0 (query only)
CURVE		<ascii curve> <binary curve>
INPUT OUTPUT		STO1 STO2 STO1 STO2
ENCDG	WAVFRM SET	ASCII BINARY ASCII BINARY
WAVFRM? (query only)		
SET? (query only)		

WFMPRE Command

This command sends the waveform preamble for use with the CURVE command. The waveform preamble is used only for scaling information. Changing the preamble does not change the size or shape of the waveform stored in memory. The order that the link in Table 3-10 appear is the order that they are transmitted, but they are, in fact, position independent on input. Any number of links may be sent with a single WFMPRE header. It is not necessary to send the complete set.

Parameters:

WFID—Waveform identification is the number of the storage area (in RAM) where the curve data resides when queried. There are only two such areas for this oscilloscope: numbers STO1 and STO2. The target storage area is determined by the INPUT command, so all arguments to the WFID link in the WFMPRE command are always ignored on input.

ENCDG—Encoding is the format of the transmitted curve data. The ENCDG link in the WFMPRE header is always ignored on input since the format of the curve data can be determined by the presence of a "%" sign (indicating a binary block transfer) at the beginning of the actual data.

NR.PT—This is the number of data points in the waveform. The data is assumed to represent the vertical values of a YT trace. A warning is issued if this value is greater than 1024 points.

XINCR—The X increment is the amount of time between data points (a uniform quantity).

XZERO—X zero is the actual zero reference point (in divisions) of the horizontal component. This can be completely off the graticule.

XMULT—X multiplier is the coefficient of the unit per division of the horizontal component of the curve.

XUNIT—X unit is the unit (dimension) of the horizontal component of the curve. This is a quoted string of zero to five characters long.

YZERO—Y zero is the actual zero reference point (in divisions) of the vertical component. This can be completely off the graticule.

YMULT—Y multiplier is the coefficient of the unit per division of the vertical component of the curve.

YUNIT—Y unit is the unit (dimension) of the vertical component of the curve. This is a quoted string of zero to five characters long.

CURVE Command

This command is followed by the actual data point values of a waveform. The data can be in ASCII or BINARY form.

```
<ascii curve> ::= CURVE<"," or space><point data>[<point data>...]
<binary curve> ::= CURVE<"," or space>%<binary count>
                  <binarypointdata>...<checksum>
```

For binary curve output, the data points are 2's complement, 10-bit integers that are right justified within the 16 bit (2-byte) field. The most significant byte is sent first. A typical transfer operation is shown in Figure 3-12.

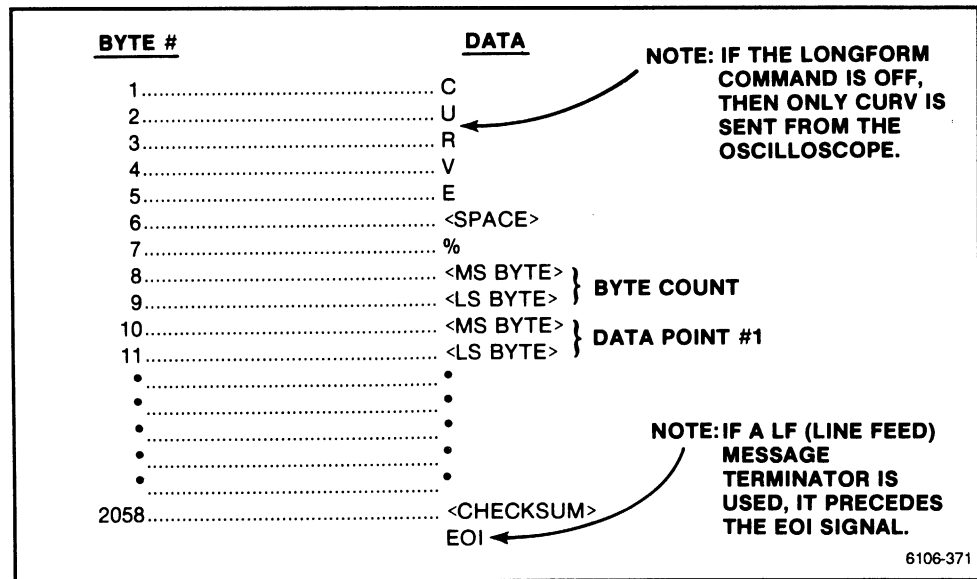

Figure 3-12. Binary Transfer Operation.

INPUT Command

This command is used to designate the target storage area for curve data sent to the oscilloscope, either STO1 or STO2.

OUTPUT Command

This command selects the target storage area used when answering a WFMPRE?, CURVE?, or WAVFRM? query. Data is always sent from the waveform location last set by this command, either STO1 or STO2.

ENCDG Command

This command selects the message format used to transmit waveforms or responses to setting queries. Data encoding is a global parameter and affects both the GPIB and RS-232-C interfaces.

Parameters:

WAVFRM—sets the message encoding for waveforms to either ASCII or BINARY.

SET—sets the message encoding of all query responses except waveforms.

WAVFRM? Query Command

This query-only command provides an abbreviated method of querying a preamble and a curve by combining the response to WFMPRE? and CURVE?.

SET? Query Command

This query-only command is sent by the controller to determine the current settings of the oscilloscope. The response contains a large number of bytes and can be encoded in ASCII or binary format with the ENCDG SET command.

Query Information

The general query form for the Waveform Preamble is WFMPRE?, which returns all links and the respective values.

Note that since there are separate commands for determining the format of curve data (the ENCDG header) and the destination storage in the oscilloscope (the INPUT header), the WFID and ENCDG links of the WFMPRE command are "query only", and ignored on input.

In addition, there are five more links (BYT/NR, BN.FMT, BIT/NR, PT.FMT, and CRVCHK) that are "query only" that specify parameters for binary data.

Any or all links can be specified. The waveform for which preamble information is returned depends upon the last argument to the OUTPUT command (STO1 or STO2).

The byte number link (BYT/NR) query response reports the number of bytes (8 bits each) in the actual curve data used to represent a single point. This is fixed at two bytes.

The binary format link (BN.FMT) response designates how the bits that represent a single data point are to be interpreted. The data points and byte count are sent in two bytes. The MS byte is sent first, with the data right-justified in two's-complement format (this is the RI format).

The bit number link (BIT/NR) query response is the binary data precision (resolution) and indicates the number of bits in each data point representation. The oscilloscope has 10 bits of resolution. The curvecheck link (CRVCHK) query response determines if a checksum byte is sent at the end of the data. A checksum is sent with a binary message, but not with an ASCII message. It is calculated as the MOD256 of the sum of all the bytes (not waveform points) in the waveform array, plus those of the byte count.

The Curve command query form is CURVE? It returns the data points in either ASCII or BINARY format, depending upon the last argument issued with the ENCDG command.

The Input command query form is INPUT?, which returns a STO1 or STO2.

The Output command query form is OUTPUT?, which returns a STO1 or STO2.

The Encoding command general query form is ENCDG?, which returns all links and their respective values. Individual links can be specified.

The WAVFRM? query-only command provides convenience for user. It is equivalent to the double query "WFMPRE?;CURVE?."

The SET? query returns all settings with respective values, in ASCII or binary format (depending on the setting of the ENCDG command), in the form:

ASCII—<setting>:<NRx>{,<setting>:<NRx>}...

BINARY—&<byte count><data>...<checksum>

General Information

Note that all absolute coordinate values can be calculated from the above information.

A command error is reported if too many data points are sent for curve data. However, all data up to 1024 points are retained. Extra data is lost.

If less than 1024 points are sent, the remaining unfilled locations are set to zero.

A command error is reported if a checksum error occurs in a binary block transfer.

Diagnostic Commands

The commands shown in Table 3-11 are used to invoke self-test routines.

TABLE 3-11
Diagnostic Commands

Header	Link	Argument
TEST		EXTENDED TERMINAL PASSED

TEST Command

This command invokes the diagnostic test indicated by the argument.



To avoid oscilloscope lockup, do not power down during a test.

The EXTENDED argument performs an extended test suite.

The TEST command without an argument results in the oscilloscope executing its self-test sequence.

The TERMINAL argument enables the display and use of the extended diagnostics on a terminal connected the RS-232-C port. This terminal mode is useful when either the display or touch panel is not functioning properly, or when it is desired to remotely use the diagnostics via a modem and phone link.

The terminal-mode commands are single keystrokes that operate and control the diagnostic functions in a manner similar to, or corresponding to, the front-panel Diagnostics Menu commands. See the operating information section, Utility Menu, of this manual for a detailed description of its commands and operations.

Query Information

The only query form is TEST?. If there are no failures to report, the response to the query is "TEST PASSED." If there are errors to report, the test identifier is returned with a four digit hex number representing the error code. The four-digit code is prepended by a host descriptor (M | L | C | R) to indicate where the error occurred, where L = left plugin, C = center plugin, R = right plugin, and M = mainframe. For specific failure information, see the manual of the indicated host.

**General
Information**

The self-test sequence halts on error, regardless of how invoked.

The EXTENDED argument runs all tests in a non-HALT/ERROR mode.

The GPIB programmer is expected to consult the Diagnostics manual for diagnostic codes; there is no verbose form.

TEST PASSED invokes SELFTEST or TEST? on return to the instrument.

Display Commands

The command shown in Table 3-12 selects either dot or vector mode.

TABLE 3-12
Display Command

Header	Link	Argument
DISPLAY		DOTS VECTORS

DISPLAY Command

This command selects the method for displaying waveforms from memory. Dots mode shows the actual data points and vector mode shows the relationship of adjacent points by connecting them with lines on the display.

Query Information An example query and related response follows:

DISPLAY?

DISPLAY DOTS

Intensity Commands

The commands shown in Table 3-13 are used to vary the intensity and contrast of waveforms or characters on the crt.

TABLE 3-13
Intensity Commands

Header	Link	Argument	Range	Resolution
INTENSITY	MAIN	<NRx>	0 to 100	1
	DELAY	<NRx>	"	"
	XY	<NRx>	"	"
	CHARACTER	<NRx>	"	"
	GRATICULE	<NRx>	"	"
CONTRAST	CHARACTER	<NRx>	"	2
	MAIN	<NRx>	"	"

INTENSITY Command

- Parameters:**
- MAIN**—Sets intensity of all YT waveforms running on main time base.
 - DELAY**—Sets the intensity of all YT waveforms running on the delayed time base.
 - XY**—Sets the intensity of all XY waveforms.
 - CHARACTER**—Sets the intensity of all readout characters, stored waveforms, and symbols.
 - GRATICULE**—Sets the intensity of the graticule lines on the crt.

CONTRAST Command

- Parameters:**
- CHARACTER**—sets the contrast between the normal character intensity and the shading.
 - MAIN**—sets the contrast between the main trace and its intensified zone when a window is present.

Query Information The general form INTENSITY? or CONTRAST? returns all links with the respective value for each. Individual query links can be specified. Query responses for all links are returned as <NR1> type numbers.

Example queries and related responses follow:

INTENSITY?

INTENSITY MAIN:50,DELAY:50,XY:50,
CHARACTER:57,GRATICULE:0

CONTRAST?

CONTRAST CHARACTER:50,MAIN:50

**General
Information**

All implied units are percentage points (0%–100%). For CHARACTER intensity, 0 represents "off", where no time-sharing with the waveforms exists.

Measurement Commands

The commands shown in Table 3-14 are used to execute built-in algorithms and return measurement values.

TABLE 3-14
Measurement Commands

Header	Link	Argument
MSLIST		EMPTY (<meas>[{,<meas>}...])
MEAS?		[TIME:"<hh:mm:ss>",DATE:"<dd mmm yy>", {<meas>}...] (query only)
AUTOMEASURE	DISPLAY	ON OFF START (SET only)

MSLIST Command

This command sets the group of measurements to be executed when AUTOMEASURE START is received or when the probe ID button is pressed. The probe button must be enabled by using the PROBE MEASURE:ON command, or by selecting the Probe ID function from the front-panel UTILITY menu.

The list of measurement selections can be executed as a block. They are performed with the counter/timer or the trigger comparators. The list of possible measurements (i.e., links) are shown in Table 3-15.

TABLE 3-15
Measure Argument Links

Measurement	<meas>
Frequency	FREQUENCY
Period	PERIOD
Width	WIDTH
Duty Factor	DUTY
Peak to Peak	PP
Maximum	MAXIMUM
Middle	MIDDLE
Minimum	MINIMUM

MEAS? Query Command

This query-only command returns the values of the current measurement list or of specified measurements (using the <meas> links). To ensure that the latest results are complete and available, this query should be performed after receipt of an Operation Complete SRQ (Status Byte = 66) and Event Code 463.

AUTOMEASURE Command

This command starts or stops the automatic measurement of the selected measurement list, as set by MSLIST, and can display them on the crt.

Parameters:

DISPLAY—enables/disables the the most recently acquired measurement results to be displayed on the crt. This is similar to pressing the Measure major menu button on the front panel.

START—begins measurement. This is similar to pressing "Start" in the Measure major menu.

Query Information

The general query form of MEAS? returns the measured values for the entire list of selected measurements. An individual measurement can then be used as a link with the MEAS? query command.

The list of specific links or measurements available can be found by using the MSLIST? query. Any subset of these links can then be sent with the MEAS? query. If no links are specified, all the links specified by the MSLIST command, with current values, are returned. The date and time arguments mark measurement completion time.

The general query form of AUTOMEASURE? returns all links and the value of each. Any link can be specified (queried).

Examples of queries and related responses follow:

AUTOMEASURE?

```
AUTOMEASURE DISPLAY:OFF
```

MSLIST?

```
MSLIST FREQUENCY, PERIOD, WIDTH, DUTY,  
PP, MAXIMUM, MIDDLE, MINIMUM
```

or

```
MSLIST EMPTY
```

MEAS?

```
MEAS TIME:"13:07:23", DATE:"23 DEC 87", FREQ:6.1E6
```

**General
Information**

An "operation complete" SRQ is issued each time a measurement block has completed if OPCMPL mask is enabled. The "busy" bit is asserted while measurements are being performed. See SRQMASK, RQS and Status commands.

If a measurement is not found, the MEAS? query will return an ASCII representation of the IEEE's "Not a Number" value. This is returned as 2.0E308. As most small computers will likely overflow when input to a numeric variable, an overflow error trap should be used by the receiving controller or computer. Otherwise, the results can be received as string a variable and tested using string comparison operations.

Miscellaneous Commands

TABLE 3-16
Miscellaneous Commands

Header	Link	Argument	Range
SELFCAL CALSTATUS?	MODE (query only)	AUTO MANUAL FORCE WARMUP NEWCONFIG UNENHANCED ENHANCED	
REDIRECT DEBUG	GPIB RS232 GPIB RS232	RS232 OFF GPIB OFF OFF SCREEN RS232 OFF SCREEN	
TIME DATE	DISPLAY SET DISPLAY SET	H24 H12 OFF "<HH>:<MM>:<SS>" ON OFF "<DD><sp><MMM> <sp><YY>"	
LONGFORM DT		ON OFF OFF CTRESET TRESET	
ABSTOUCH FPANEL INIT	(set only) (set only)	<NR1>,<NR1> ON OFF	0 to 9, 0 to 22
HELP? DATIME? UPTIME? POWERON?	(query only) (query only) (query only) (query only)	"<DD><sp><MMM><sp><YY>", "<HH>:<MM>:<SS>" <NRx> <NRx>	
CALIBRATOR	FREQUENCY AMPLITUDE TYPE	<NRx> <NRx> SQUARE FASTRISE	1E2 to 1E6 5E-1 to 5
SPEAKER		LOUD SOFT OFF	

SELFCAL Command

This command determines how self-calibration is initiated from the front panel and additionally starts execution via remote control. Note that SELFCAL FORCE is a set-only command. Execution error 236 is reported when this command is invoked before the 20-minute warmup expires.

Parameters: **MODE**—selects initiation mode for oscilloscope self-calibration.

CALSTATUS? Query Command

This query-only command reports the calibration status condition of the oscilloscope and the plug-in units.

REDIRECT Command

This command allows output from one port to be directed out the other. Output is **DUPLICATED** to the alternate port, not really redirected.

Parameters:

GPIB—enables or disables the duplication of GPIB query responses at the RS-232-C port.

RS232—enables or disables the duplication of RS-232-C query responses at the GPIB port.

DEBUG Command

This command allows the GPIB programmer to direct debug information (input transactions and error codes) to the crt or the serial port (or shut it off altogether). Debug is all **INPUT** from the port (as opposed to **OUTPUT**, controlled by the **REDIRECT** command).

Parameters:

GPIB—enables the directing of GPIB input and error codes to the screen or RS-232-C port.

RS232—enables the directing of RS-232-C input and error codes to the screen.

LONGFORM Command

This command enables long form output for query responses. With **LONGFORM OFF**, all commands, links, and arguments are reduced (on output) to the least characters required to eliminate ambiguity, and responses to **EVENT?** or **ALLEV?** contain only the event code. A command or query is always accepted by the oscilloscope (on input) in any form from the minimum to the full length. If **LONGFORM** is **ON**, the response to an **EVENT?** or **ALLEV?** contains a text string describing the event in addition to the event code.

TIME Command

This command sets and enables or disables the display of the oscilloscope internal clock.

DATE Command

This command sets and enables or disables the display of the oscilloscope internal calendar.

DT Command

This command determines what action the oscilloscope will take upon receiving a Group Execute Trigger. OFF means no action is taken. CTRESET is the same as the CTRESET command. TRESET is the same as a TRMAIN RESET:RDY command.

ABSTOUCH Command

This command allows the controller to select a cell on the touch panel or a front-panel button by column number and row number ($0 \leq \text{row numbers} \leq 22$) regardless of the current menu. Each 5 characters across the screen form one column ($0 \leq \text{column numbers} \leq 9$). The first argument is the column number and the second argument is the row number. Refer to Table 3-17.

An execution warning is issued if arguments are out of range.

An execution error is reported (263) if a nonexistent channel is specified.

An execution error is reported (296) for any button undefined. Refer to Table 3-17.

NOTE

No distinction is made between rows 0 and 1, and between rows 14 and 15. Rows 16-22 are buttons and knobs, and are not located on the touch screen.

FPANEL Command

This command enables or disables the front panel, and is a functional equivalent to the LLO (local lockout) and GTL (go to local) messages over GPIB. Its primary purpose is to mimic these commands via RS-232-C. When FPANEL is OFF, user-defined menus on the touch panel must still be able to assert SRQ (if USER:ON). All other controls are inoperative.

TABLE 3-17
Touch Translation Table Layout

	0	1	2	3	Touch Column Nos.		6	7	8	9
					4	5				
	00-04	05-09	10-14	15-19	Char. Column Nos. 20-24	25-29	30-34	35-39	40-44	45-49
00										
01										
02										
03										
04										
05										
06										
07										
08										
09										
10										
11										
12										
13										
14										
15										
16	WAVE-FORM	TRIGGER SOURCE		MEASURE	UTILITY	STORE RECALL	DISP ADJ (FOCUS)	NUMERIC ENTRY		
17	rt fine button	MEASURE CURSORS	HORIZ POS	HORIZ SIZE	HORIZ DELAY	TRIGGER LEVEL	TRIGGER RESET		rt knob cw	rt knob ccw
18	lft fine button	MEASURE COUNTER	VERTICAL POS	VERTICAL SIZE	VERTICAL OFFSET	TRIGGER HOLDOFF			lft knob cw	lft knob ccw
19	channel L1 id	channel L2 id	channel L3 id	channel L4 id		BEAMFIND off	ENHANCED ACCURACY	BEAMFIND on	top knob cw	top knob ccw
20	probe L1 id	probe L2 id	probe L3 id	probe L4 id	AUTOSET	SRQ	INTENSITY dwn arrow	INTENSITY up arrow		
21	channel C1 id	channel C2 id	channel C3 id	channel C4 id	channel R1 id	channel R2 id	channel R3 id	channel R4 id		
22	probe C1 id	probe C2 id	probe C3 id	probe C4 id	probe R1 id	probe R2 id	probe R3 id	probe R4 id		

TOUCH ROW NUMBERS

NOTE: No distinction is made between rows 0 and 1 and between rows 14 and 15. Rows 16-22 are buttons and knobs. They are not actually located on the touch screen.

INIT Command

This command initializes the oscilloscope to its factory assigned default parameters. This is a set-only command.

HELP? Query Command

This query-only command returns all valid command headers.

DATIME? Query Command

This query-only command returns both the date and time, in the form:

```
DATIME <time string>,<date string>
```

UPTIME? Query Command

This query-only command returns the number of hours the instrument has been powered on since manufacture in the form:

```
UPTIME <NR1>
```

POWERON? Query Command

This query-only command returns the number of times the instrument has been powered on since manufacture, in the form:

```
POWERON <NR1>
```

CALIBRATOR Command

This command controls the amplitude, repetition rate, and signal type of the front panel calibrator probe hook and bnc connector.

Parameters:

FREQUENCY—sets the calibrator frequency to the value specified by the argument. The frequency can be set to 100 Hz, 1 kHz, 10 kHz, 100 kHz, and 1 MHz. The 1 MHz setting can only be used when TYPE is FASTRISE.

AMPLITUDE—sets the calibrator amplitude to the value specified by the argument. The amplitude can be set to 500 mV (5E-3) or 5 V. The 5 V setting can only be used when TYPE is SQUARE.

TYPE—sets the calibrator to the kind of waveform specified by the argument.

SPEAKER Command

This command controls the characteristics of the audio output for the oscilloscope.

Query Information The query form for SELFCAL? returns the MODE link and its current argument, in the form:

```
SELFCAL MODE:<arg>
```

The CALSTATUS? response is returned in the following form:

```
CALSTATUS <qstring>
```

Where qstring is:

- **WARMUP**—during the first 20 minutes of operation.
- **ENHANCED**—after selfcal has been invoked, but before temperature drift. See the specifications for calibration data.
- **UNENHANCED**—after temperature drift.
- **NEWCONFIG**—after warmup and if the plug-in configuration has changed.

The general query for REDIRECT? returns all links and the current argument with each in the form:

```
REDIRECT GPIB:<arg>,RS232:<arg>
```

Each link can be queried.

The general query for DEBUG? returns all links with the current argument for each in the form:

```
DEBUG <GPIB>:<arg>,<RS232>:<arg>
```

Each link can be queried.

The general query for LONGFORM? returns the current argument.

The general query for TIME? returns all links with the current argument for each in the form:

```
TIME DISPLAY:<arg>,SET:<time arg>
```

The general query for DATE? returns all links with the current argument for each in the form:

```
DATE DISPLAY:<arg>,SET:<date arg>
```

The general query for DT? returns the current argument in the form:

```
DT <arg>
```

The general query for FPANEL? returns the current argument in the form:

```
FPANEL <arg>
```

The HELP? response is returned in the following form:

```
HELP <data>[ {, <data>} ... ]
```

The header list may change with configuration changes. For example, CHR3 is not returned if there is no plug-in unit in the right compartment, or if it is only a two-channel plug-in unit.

The DATIME? response is returned in the following form:

```
DATIME <date arg>, <time arg>
```

The UPTIME? response is returned in the following form:

```
UPTIME <NRx>
```

This is a cumulative figure.

The POWERON? response is returned in the following form:

```
POWERON <NR1>
```

This is a cumulative figure.

The general query for the CALIBRATOR? returns all links with the current argument for each in the form:

```
CALIBRATOR FREQUENCY: <NRx>, AMPLITUDE: <NRx>, TYPE: <arg>
```

The SPEAKER? response is returned in the following form:

```
SPEAKER <arg>
```

Examples of queries and related responses follow:

```
REDIRECT?
```

```
REDIRECT GPIB:OFF, RS232:OFF
```

```
LONGFORM?
```

```
LONGFORM ON
```

TIME?

TIME DISPLAY:H12,SET:"01:25:13"

DATE?

DATE DISPLAY:ON,SET:"26 OCT 87"

DT?

DT OFF

DEBUG?

DEBUG GPIB:OFF,RS232:OFF

HELP?

HELP CH,CHL,CHC,CHR,CHL1,CHL2,CHL3,CHL4,CHC1,CHC2,CHC3,CHC4,CHR1,CHR2,CHR3,CHR4,TBDISPLAY,TBGATEOUT,TBMAIN,TBDELAY,TR,TRMAIN,TR1DELAY,TR2DELAY,TRAEXT,TRBEXT,HOLDOFF,HOEVENT,HOCOUNTDOWN,WIN1,WIN2,WIN,WTMODE,DISPLAY,INTENSITY,CONTRAST,TEXT,CURSOR,HCURSOR,V1ABS,V1REL,V2ABS,V2REL,H1ABS,H1REL,H2ABS,H2REL,HDELTA,VDELTA,VREF,HREF,TRACE,TRACE1,TRACE2,TRACE3,TRACE4,TRACE5,TRACE6,TRACE7,TRACE8,SELECT,RECALL,STORE,ERASE,CLEAR,CTRESET,CTMEAS,CTRESULT,CTFREQUENCY,CTPERIOD,CTWIDTH,CTTOTAL,CTRATIO,CTTIME,CTCLOCK,WFMPPRE,CURVE,INPUT,OUTPUT,ENCDG,WAVFRM,MSLIST,MEAS,AUTOMEASURE,RQS,SQMASK,EVENT,EVQTY,ALLEV,ID,STBYTE,IDPROBE,VERSION,CONFIG,UID,SET,TEST,RS232,PROBE,AUTOSET,SELFCAL,CALSTATUSREDIRECT,LONGFORM,TIME,DATE,DT,ABSTOUCH,DEBUG,FPANEL,INIT,HELP,DATIME,UPTIME,POWERON,CALIBRATOR,SPEAKER,SETACVS,SETCVR,SETPWM,FACTORYATOD,ATODRESULT,MCALCONSTANT,LCCALCONSTANT,CCALCONSTANT,RCALCONSTANT,GRATDETECT,SAVEFACTORY,AUTOCAL,CTTW,CTCW,CTR,CTSW,CTSWR,ROCS

UPTIME?

UPTIME 107

CALIBRATOR?

CALIBRATOR FREQUENCY:1.0E+3,AMPLITUDE:5.0,TYPE:SQUARE

SPEAKER?

SPEAKER SOFT

Probe ID Commands

Probe ID Commands

Header	Link	Argument	Range
PROBE SEQUENCE MEASURE	AUTOSET ON OFF ON OFF	ON OFF	

PROBE Command

This command selects the operation(s) to be performed when the probe ID button is pushed. All three links can be enabled at once.

Parameters:

AUTOSET—enables or disables the probe ID button actuation of Autoset. If enabled, pressing the probe ID button autosets the associated channel.

SEQUENCE—enables or disables the probe ID button actuation of sequential setting recall

MEASURE—enables or disables probe ID button actuation of measurements found in the MEASURE major menu or selected using the MSLIST command.

Query Information

The general query form for PROBE? returns all links and the current argument with each, in the form:

```
PROBE <link>:<arg>[,{<link>:<arg>}...]
```

Individual links can be queried.

Examples of queries and related responses follow:

```
PROBE?
```

```
PROBE AUTOSET:ON, SEQUENCE:OFF, MEASURE:OFF
```

RS-232-C Control Commands

TABLE 3-18
RS-232-C Control Commands

Header	Link	Argument	Range
RS232	BAUD DELAY ECHO FLAGGING PARITY STOPBITS SRQ EOL CHARBITS HARDLINE	<NRx> <NRx> ON OFF SOFT HARD ODD EVEN NONE <NR1> BREAK ASCII CR CRLF LF LFCR <NR1> CTS DSR	110 to 9600 0 to 65535

RS232 Command

This command sets parameters for the serial port.

Parameters:

NOTE

See the Special RS-232-C I/O Considerations information, earlier in this section, for related information.

BAUD—selects the baud rate for the RS-232-C interface port. Both transmit and receive baud rates are set by this command. Baud rates are 110, 150, 300, 600, 1200, 2400, 4800, 9600.

DELAY—sets the minimum delay from receipt of an RS-232-C query to its response. This command allows an RS-232-C controller time to prepare to receive the response from a query before the response is transmitted. The argument represents the minimum delay in 10 millisecond increments. The valid range is from 0 to 32,767, or 327.67 seconds.

ECHO—turns RS-232-C echo on or off. When echo is on, all characters received from the RS-232-C port are echoed. When echo is off, input characters are not echoed.

FLAGGING—can be set to HARD or SOFT. Selecting SOFT allows the oscilloscope to recognize incoming XON/XOFF characters to mean enable/disable transmission, and tells the oscilloscope to send XON/XOFF characters to start/stop the transmission of the controller. XOFF is sent when the oscilloscope buffer is 3/4 full. XON is sent when a previous XOFF has been transmitted, a following XON has NOT been transmitted, and the buffer is 1/4 full.

If HARD flagging is selected, the oscilloscope monitors two lines of the RS-232-C interface to achieve flow control. The oscilloscope only transmits when connector pin #4 RTS (8251A USART PIN #17 CTS) is low (0, unasserted). Depending on the HARDLINE selection, the oscilloscope uses either connector pin #6 DSR or connector pin #5 CTS (8251A USART PIN #24 DTR and PIN #23 RTS respectively) to enable/disable the transmission of the controller. When the line is high (1, asserted) the controller is free to transmit.

It should be noted that connector pin #4 RTS must be low (0, unasserted) before the oscilloscope can transmit, regardless of the FLAGGING selection. For this reason, there is no OFF selection for FLAGGING, since the oscilloscope transmission ability is always qualified by pin #4.

It should be noted the the use of SOFT FLAGGING is not compatible with the exchange of binary data, since XON/XOFF are transmitted asynchronously, and cannot be distinguished from data bytes of the same ASCII value in a binary stream. Do not use SOFT FLAGGING if you are receiving/transmitting binary data.

PARITY—selects the parity used for all RS-232-C data transfers. The oscilloscope generates the selected parity on output and checks all input against the selected parity. When parity is ODD or EVEN, and an input parity error is detected, an internal error warning is returned. When parity is None, no input parity error checks are performed, and no output parity is generated.

STOPBITS—selects the number of stops bits (1 OR 2) transmitted with each character on the RS-232-C interface. The instrument will always accept one or more stop bits on input.

CHARBITS—selects the number of character bits (7 OR 8) recognized for data. Do not use seven character bits if transmitting binary data.

SRQ—selects the service request reporting mode over the RS-232-C interface. When BREAK mode is selected, the instrument sends a break character whenever an interrupt occurs. When ASCII is selected, the instrument sends an ASCII message, in the form STBYTE <NR1>, whenever an interrupt occurs. The ASCII message is modified by longform.

EOL—selects the type of end-of-line string that terminates each query transmitted from the oscilloscope to its RS-232-C port.

HARDLINE—This command selects which of two control lines in the RS-232-C interface is used to enable transmission from the controller when HARD flagging is in effect. HARDLINE CTS tells the oscilloscope to toggle connector pin #5 (CTS), while HARDLINE DSR tells the oscilloscope to toggle connector pin #6 (DSR). The line that is monitored by the oscilloscope to start or stop its own transmission is fixed at connector pin #4 (RTS).

Query Information The general query form for RS232? returns all links and their current arguments, in the form:

```
RS232 BAUD:<NR1>,DELAY:<NR3>,ECHO:<arg>,FLAGGING:<arg>,  
      PARITY:<arg>,STOPBITS:<NR3>,SRQ:<arg>,  
      HARDLINE<arg>,CHARBITS<arg>
```

Individual links can be queried.

Examples of queries and related responses follow:

```
RS232?
```

```
RS232 BAUD:9600,DELAY:0,ECHO:OFF,FLAGGING:HARD,  
      PARITY:NONE,STOPBITS:1,CHARBITS:8,SRQ:ASCII,  
      EOL:CR,HARDLINE:CTS
```

Status and Event Commands

The commands shown in Table 3-19 are used to control and report the details of operating status to the controller.

TABLE 3-19
Status and Event Commands

Header	Link	Argument
RQS		ON OFF
SRQMASK	CMDERR EXERR INERR EXWARN INWARN OPCMPL USER IDPROBE CALDUE	ON OFF ON OFF ON OFF ON OFF ON OFF ON OFF ON OFF ON OFF ON OFF
EVENT? EVQTY? ALLEV?		<NR1>[<qstring>] (query only) <NR1> <NR1>[<qstring>][{,<NR1>[<qstring>]}...] (query only)
ID? STBYTE?		TEK / <model #>, <C&F Ver. #> (query only) <NR1> (query only)
IDPROBE?		<qstring> (query only)
VERSION?	MAIN LEFT CENTER RIGHT	<qstring> (query only) <qstring> (query only) <qstring> (query only) <qstring> (query only)
CONFIG?	MAIN LEFT CENTER RIGHT	<qstring> (query only) <qstring> (query only) <qstring> (query only) <qstring> (query only)
UID	MAIN LEFT CENTER RIGHT	<qstring> <qstring> <qstring> <qstring>

RQS Command

This command allows a controller to globally enable/disable the ability of a device to assert SRQ (port dependent). RQS ON enables this ability, RQS OFF disables it.

SRQMASK Command

This command allows a controller to selectively enable/disable classes of service requests (as indicated by the links). If RQS OFF has been received, an SRQ is not reported, regardless of the status of the links. See the Event Code tables later in this section.

Parameters:

CMDERR—Command error SRQ enabled or disabled.

EXERR—Execution error SRQ enabled or disabled.

INERR—Internal error SRQ enabled or disabled.

EXWARN—Execution warning SRQ enabled or disabled.

INWARN—Internal warning SRQ enabled or disabled.

OPCMPL—Operation complete SRQ enabled or disabled.

USER—Front-panel touch SRQ enabled or disabled.

IDPROBE—Probe ID button SRQ enabled or disabled.

CALDUE—enables or disables any SRQ resulting from one or more self-cal messages. See Status and Event Reporting later in this section.

UID Command

This command allows the controller to give an identifying name to the mainframe and to each plug-in. At the factory, this name is set to be the serial number to aid in its manufacture. The name must be a quoted string of 10 characters or less.

EVENT? Query Command

This query-only command is sent by the controller to gain more information about the event reported in the last serial poll status byte.

EVQTY? Query Command

This query-only command is sent by the controller to determine how many events are pending (queued, waiting to be polled up to a maximum of 43).

ALLEV? Query Command

This query-only command is sent by the controller to get all (stacked) events, whether they be polled, current, or pending.

ID? Query Command

This query-only command is sent by the controller to gain information about the device that is connected to the interface; thus, enabling the determination of the system configuration.

STBYTE? Query Command

This query-only command is sent by the controller to get a status byte from the oscilloscope, via its RS-232-C interface only.

IDPROBE? Query Command

This query-only command is sent by the controller to determine the probe last selected with the probe ID button.

VERSION? Query Command

This query-only command is sent by the controller to determine firmware version number of the specified device(s); thus, enabling the determination of the system configuration.

CONFIG? Query Command

This query-only command is sent by the controller to determine which plug-in units are currently installed. Again, this helps determine characteristics of the system configuration. A unique string identifying the installed plug-in unit is returned for each link.

Parameters:

MAIN—A CONFIG? MAIN query is defined to be identical to the ID? query.

LEFT—identifies the left plug-in unit.

CENTER—identifies the center plug-in unit.

RIGHT—identifies the right plug-in unit.

Query Information The general query RQS? returns the currently selected argument in the form:

RQS <arg>

The general query SRQMASK? returns all the links and their current arguments in the form:

SRQMASK <link>:<arg>{,<link>:<arg>}...

EVENT? returns an <NR1> type number. This response is affected by the LONGFORM command. When LONGFORM is ON, the EVENT <NR1> response is followed by a comma and a quoted string description of the event.

EVQTY? returns an <NR1> type number.

ALLEV? returns a response in the form:

ALLEV <NR1>[{,<NR1>}...].

This response is also affected by the LONGFORM command.

ID? returns a response in the form:

ID TEK/<model #>,<C&F Ver. #>

The STBYTE? query returns a status code (an <NR1> type number) listed in the Status and Event Reporting information, later in this section. The response form is:

STBYTE <NR1>

A Command Error is reported when it is received over the GPIB.

IDPROBE? returns the unique string identifying the probe name, in the form:

IDPROBE "<probe name string>"

VERSION? returns the version of the installed firmware in the form:

VERSION <link>:"<version num>"
[,<link>:"<version num>"]...

All links can be queried.

CONFIG? returns a unique string that identifies each installed plug-in unit, in the form:

CONFIG MAIN:<qstring>,<LEFT:<qstring>,<CENTER:<qstring>,<RIGHT:<qstring>

Each link can be queried.

Examples of queries and related responses follow:

RQS?

RQS ON

SRQMASK?

SRQMASK CMDERR:ON, EXERR:ON, INERR:ON, EXWARN:ON, INWARN:ON,
OPCMPL:ON, USER:OFF, IDPROBE:OFF, CALDUE:ON

EVENT?

EVENT 101, "Invalid command header"

EVQTY?

EVQTY 26

ALLEV?

ALLEV 107, "Invalid delimiter", 151, "Symbol or number too
long", 400, "No status to report"

ID?

ID TEK/11301, V81.1

STBYTE?

STBYTE 1

Store Recall Commands

TABLE 3-20
Store Recall Commands

Header	Link	Argument
RECALL STORE ERASE		FPNEXT FPS<ui> FPS<ui> FPS<ui>

RECALL Command

FPNEXT—selects the ((current selected front-panel setting number + 1) mod 10) as the currently selected front-panel configuration.

STORE Command

This command saves the current front-panel configuration in one of the ten memory) areas, as indicated by the argument.

ERASE Command

This command erases one of the ten memory areas used for storing front-panel settings, as indicated by the argument.

Parameters:

FPS<ui>—selects the stored front-panel setting indicated by the argument as the current front-panel configuration.

Permissible <ui> arguments for FPS<ui> are 0 through 9.

TRNEXT and **FPNEXT**—are "set only" command links; hence, there is no query. The commands **STORE**, **ERASE**, and **CLEAR** are "set only"; hence, there is no query.

Text Commands

The command shown in Table 3-21 is used to display text in the major menu area only.

TABLE 3-21
Text Command

Header	Link	Argument	Range
TEXT	X Y STRING	<NRx> <NRx> <qstring> CLEAR	0 to 49 0 to 7

TEXT Command

Parameters:

X—sets the column where text is to begin.

Y—sets the row where text is to begin.

STRING—determines the actual characters to be displayed. This may include embedded special characters. This string must be terminated using a quote.

CLEAR—clears the entire text area of all displayed text.

Query Information

The query form is TEXT? and always returns eight lines (the entire major menu area) of text from the screen, in the form:

```
TEXT X:0,Y:0,STRING:<qstring>
```

General Information

Note that for this command only, the upper left corner of the major menu area is considered to be (0,0). Coordinate 0,0 is the upper left corner of the third graticule line from the top at the far left edge of the screen. See Table 3-31 and 3-32, (ASCII and Escaped Character Sets, respectively).

Time Base Commands

The commands shown in Table 3-22 are used to set scaling and other parameters of the main or delayed time base:

TABLE 3-22
Time Base Commands

Header	Link	Argument	Range	Resolution
TBDISPLAY	VIEW MUX	MAIN BOTH DELAY ALTERNATE CHOP AUTO		
TBGATEOUT		MAIN DELAY		
TBMAIN TBDELAY	TIME MAGNIFIER POSITION	<NRx> ON OFF <NRx>	5E -9 to 1.5 -5 to +5	See Table 3-21 0.01 (10X Mag Off) 0.025 (10X Mag On)

TBDISPLAY Command

TBDISPLAY selects the way in which multiple analog traces are multiplexed to form the display. VIEW selects whether to present MAIN time base traces only, DELAYed time base traces only, or BOTH main and delayed traces for viewing. MUX selects the display multiplexing scheme of CHOP, ALT, or AUTO.

TBGATEOUT Command

This command sets the rear panel SWEEP GATE OUT signal to either the main or the delayed sweep gate.

TABLE 3-23
Time Base Resolution

Time/Div Setting	Resolution
5E-9 to 9.95E-9	5E-11
1E-8 to 1.99E-8	1E-10
2E-8 to 4.98E-8	2E-10
5E-8 to 9.95E-8	5E-10
1E-7 to 1.99E-7	1E-9
2E-7 to 4.98E-7	2E-9
5E-7 to 9.95E-7	5E-9
1E-6 to 1.99E-6	1E-8
2E-6 to 4.98E-6	2E-8
5E-6 to 9.95E-6	5E-8
1E-5 to 1.99E-5	1E-7
2E-5 to 4.98E-5	2E-7
5E-5 to 9.95E-5	5E-7
1E-4 to 1.99E-4	1E-6
2E-4 to 4.98E-4	2E-6
5E-4 to 9.95E-4	5E-6
1E-3 to 1.99E-3	1E-5
2E-3 to 4.98E-3	2E-5
5E-3 to 9.95E-3	5E-5
1E-2 to 1.99E-2	1E-4
2E-2 to 4.98E-2	2E-4
5E-2 to 9.95E-2	5E-4
1E-1 to 1.99E-1	1E-3
2E-1 to 4.98E-1	2E-3
5E-1 to 9.95E-1 ¹	5E-3
1 to 1.5 ¹	1E-2

¹ TBDELAY TIME has a maximum setting of 0.6 s/div.

TBMAIN & TBDELAY Commands

These commands set the scaling and position of the main and delayed time bases.

Parameters:

TIME—sets the indicated time base to the time/division setting as indicated by the argument. The implied units are seconds. The argument assumes that the **MAGNIFIER** is OFF.

NOTE

If the magnifier is On, the actual Time/div is 1/10 the amount set (e.g. 10 μ s/div setting becomes 1 μ s/div).

MAGNIFIER—sets the indicated time-base magnifier to the selected argument. ON is a 10 times magnification. Magnification is independent between main and delay time bases.

POSITION—sets the horizontal position of all YT traces using the indicated time base to the display offset value indicated by the argument. The units are divisions. Note that this command affects only YT traces. The argument assumes that the **MAGNIFIER** is OFF. If the **MAGNIFIER** is ON, the displayed position is 10 times the value set by this command.

Query Information

The general form of the query is **TBMAIN?** (or **TBDELAY?**), which returns all links and the current value of each. Links can be specified (e.g., **TBMAIN?TIME**). The query for links **TIME** and **POSITION** returns a type <NR3> number.

Examples of queries and related responses follow:

TBDISPLAY?

TBDISPLAY MUX:ALTERNATE,VIEW:MAIN

TBGATEOUT?

TBGATEOUT MAIN

TBMAIN?

TBMAIN TIME:5.00E-6,MAGNIFIER:OFF,POSITION:1.2

TBDELAY?

TBDELAY TIME:1.00E-6,MAGNIFIER:OFF,POSITION:800E-3

Trigger Commands

The commands shown in Table 3-24 are used to select, define, and qualify the behavior of the triggering system.

TABLE 3-24
Trigger Commands

Header	Link	Argument	Range	Resolution
TRMAIN	COUPLING SOURCE MODE RESET SLOPE LEVEL SENSITIVITY	ACLF AC DC ACHF DCHF <trig expr> PP AUTO NORM SSEQ RDY TRIGGER PLUS MINUS <NRx> LOW MEDIUM HIGH	-10 to +10	0.01
TR1DELAY TR2DELAY	COUPLING SOURCE RESET SLOPE LEVEL SENSITIVITY	ACLF AC DC ACHF DCHF <trig expr> RDY TRIGGER PLUS MINUS <NRx> LOW MEDIUM HIGH	-10 to +10	0.01
TRAEXT TRBEXT	SLOPE LEVEL	PLUS MINUS <NRx>*	-0.5 to +0.5	2.5E-3
TR? (query only)				

*When set to EXT/5, range is from -2.5 to +2.5, and resolution is 1.25E-2

TRMAIN, TR1DELAY & TR2DELAY, and TRAEXT & TRBEXT Commands

TRMAIN controls the main time base trigger. TR1DELAY & TR2DELAY control the window one and window two delayed time base triggers. TRAEXT controls the CT EXT A trigger. This is the A External input to the counter/timer. TRBEXT controls the CT EXT B trigger. This is the B External input to the counter/timer.

Parameters:**NOTE**

The delayed time base and counter/timer trigger commands have links that perform similar functions to the corresponding main time-base trigger parameters. Hence, similar links are described only once for main, delayed, and Counter/Timer trigger commands.

COUPLING—sets the currently selected trigger coupling to the selected argument. (ACLF is ac low-frequency reject, ACHF is ac high-frequency reject, DCHF is dc high-frequency reject coupling.)

SOURCE—selects the trigger source indicated by <trig expr> as the currently selected trigger.

MODE—sets the currently selected trigger mode indicated by the argument. (PP is peak-to-peak and SSEQ is single-sequence triggering.)

RESET—TRMAIN RESET:RDY arms the main and delayed triggers. When queried, RESET:RDY indicates an armed state for the respective trigger. RESET:TRIGGER indicates that the respective trigger has been fired. TR1DELAY and TR2DELAY are not independent. A change in either 1 or 2 will be reported in both TR1 and TR2.

SLOPE—sets the edge sensitivity of the currently selected trigger to the slope indicated by the argument.

LEVEL—for TRMAIN, TR1DELAY, and TR2DELAY, the trigger level is expressed as a value ranging from -10 to +10 where -10 is the minimum or 0% and +10 is the maximum or 100%. Level for TRAEXT and TRBEXT is expressed in volts.

SENSITIVITY—sets the trigger comparator sensitivity. High is the most sensitive to noise and signal transitions, while low is the most stable setting for noisy signals, and medium is in between.

Query Information

The general form is TRMAIN? (or TR1DELAY?, TRAEXT?, etc.), which returns all links, with current values. Links may be specified (e.g., TR2DELAY? SLOPE). In addition, there is a TR? query, which returns all links for the main and delayed triggers, but without the TR header as part of the response. "TR?" is a special query-only, short-hand way to invoke the "TRMAIN?", "TR1DELAY", and "TR2DELAY" queries all at once. The query for the LEVEL link returns a type <NR3> number. The TRIGGER argument in the RESET link is "query only". Again, its intended use is to indicate that the trigger has fired when in single-sequence mode.

Examples of queries and related responses follow:

TRMAIN?

TRMAIN COUPLING:AC, SOURCE:L1-L2, MODE:PP, RESET:RDY,
SLOPE:PLUS, LEVEL:0, SENSITIVITY:MEDIUM

TR1DELAY?

```
TR1DELAY COUPLING:AC, SOURCE:L1-L2,
        RESET:RDY, SLOPE:PLUS,
        LEVEL:0, SENSITIVITY:MEDIUM
```

TR2DELAY?

```
TR2DELAY COUPLING:AC, SOURCE:L1-L2,
        RESET:RDY, SLOPE:PLUS,
        LEVEL:0, SENSITIVITY:MEDIUM
```

TRAEXT?

```
TRAEXT SLOPE:PLUS, LEVEL:20.0E-3
```

TRBEXT?

```
TRBEXT SLOPE:PLUS, LEVEL:10.0E-3
```

General Information

Execution warnings are issued for out-of-range arguments to the LEVEL link. Note that only the COUPLING, SOURCE, SLOPE, and LEVEL links are independent between the main and delayed time bases.

The definitions of the main and delayed trigger source arguments are:

```
<trig expr> ::= <normal expr> | <external expr> | UNDEF
<normal expr> ::= [<oper>] <compartment><ch>
                [<oper><compartment>]
<external expr> ::= LINE | EXT | EXT/5
<oper> ::= +|-
<compartment> ::= L|C|R
<ch> ::= 1|2|3|4
```

Additional Constraints

See Section 2 for more detail.

If the <compartment> that precedes <ch> does not contain an 11000-series plug-in, <ch> must be omitted. In this case, the <oper> that precedes <compartment> cannot be "-".

For 11000-series generic plug-in units, if <compartment> equals "R", then both <compartment>s in <normal expr> must equal "R". A unique {<compartment><ch>} combination may only appear once in each <normal expr>.

Some values of <ch> are not always valid, depending on the current plug-in configuration. For example, "3" and "4" are not valid if the plug-in unit has only two channels. Additionally, depending on the contents of the main <trig expr>, the delayed <trig expr> may change when the main <trig expr> changes. A warning message appears if this occurs. Also, some combinations of the delayed <trig expr> that are normally legal are illegal, depending on the current makeup of the main <trig expr>. The basic rule of thumb: If any channel of a plug-in is used in the main <trig expr>, then the only valid usage of that plug-in in the delayed <trig expr> is the same as that used in the main <trig expr>.

The value "UNDEF" causes the trigger source to be deleted.

Trigger Holdoff Commands

The commands shown in Table 3-25 control the main time base repetition rate by holding off the start of the main sweep.

TABLE 3-25
Trigger Holdoff Commands

Header	Link	Argument	Range	Resolution
HOLDOFF	TIME	<NRx>	0 to 1E2	0.01
	STEP2NS	<NRx>	2.556E-6 to 966.36764E-3	1.8E-9
	COUNTDOWN	<NRx>	2 to $(2^{29}) - 1$	1
	EVENT	<NRx>	2 to $(2^{29}) - 1$	1
	TYPE	TIME STEP2NS COUNTDOWN EVENT		
HOEVENT	MODE ONESTART COUNT START	RUNS TRIGGER ON OFF STEP2NS MAINTRIG DLYTRIG BEXT MAINTRIG AEXT NONE		
HOCOUNTDOWN	NEXT	<NRx> (set only)	1 to $(2^{29}) - 1$	
	PREVIOUS	<NRx> (set only)	1 to $(2^{29}) - 1$	

HOLDOFF Command

This command sets the amount of holdoff for the different modes or types of holdoff.

Parameters:

TIME—sets the holdoff time as a percent of maximum. This depends on the time/div. In Table 3-26, the minimum holdoff time is shown. To find the maximum holdoff by time, add the figure under the "Time" heading to the minimum holdoff time.

STEP2NS—sets the time between the start of a main sweep and when the succeeding main sweep may be triggered. The entry is rounded to the nearest 1.8 ns. The range is limited to a minimum that is main-sweep Time/div dependent. The maximum is approximately one second. Table 3-26 also describes the minimum holdoff time when using STEP2NS. If the entry is less than the minimum, an error is reported.

EVENT—sets the number of events of unknown time to holdoff the main sweep between triggers.

COUNTDOWN—sets the number of Main Trigger events to occur between successive Main Sweeps. These are settable in the range from 2 to $2^{29}-1$ (536,870,911).

NOTE

The minimum time from one Main Sweep to the next is shown in Table 3-10 below. When holdoff type is COUNTDOWN, failure to make the count cycle time exceed the minimum times shown can cause the Main Sweep to cease operation or to cycle in a shorter period of time than that defined by the count setting.

TABLE 3-26
Minimum Holdoff Time for 2ns Step and Countdown

Main Time/div	Minimum Holdoff
5 ns	3.00 μ s
>5 ns to 10 ns	3.10 μ s
>10 ns to 20 ns	3.20 μ s
>20 ns to 50 ns	3.50 μ s
>50 ns to 100 ns	4.30 μ s
>100 ns to 200 ns	5.50 μ s
>200 ns to 500 ns	9.80 μ s
>500 ns to 1 μ s	16.0 μ s
>1 μ s to 2 μ s	30.0 μ s
>2 μ s to 5 μ s	78.0 μ s
>5 μ s to 10 μ s	160 μ s
>10 μ s to 20 μ s	300 μ s
>20 μ s to 50 μ s	780 μ s
>50 μ s to 100 μ s	1.60 ms
>100 μ s to 200 μ s	3.00 ms
>200 μ s to 500 μ s	7.80 ms
>500 μ s to 1 ms	16.0 ms
>1 ms to 2 ms	30.0 ms
>2 ms to 5 ms	78.0 ms
>5 ms to 10 ms	160 ms
>10 ms to 20 ms	300 ms
>20 ms to 50 ms	780 ms
>50 ms to 100 ms	1.60 s ¹
>100 ms to 200 ms	3.00 s ¹
>200 ms to 500 ms	7.80 s ¹
>500 ms	20.0 s ¹

¹Applies only to Countdown.

All holdoff types must not result in an actual holdoff time less than the minimum in this table. Care must be taken when using COUNTDOWN as the oscilloscope cannot predict the timing relationship of the incoming events.

EVENT—sets the number of selected events to delay the main sweep.

TYPE—selects which of the four delays to use.

HOEVENT Command

This command sets the particular variations of holdoff when the holdoff type is designated to be by event (i.e., `HOLDOFF TYPE:EVENT`).

Parameters:

MODE—selects whether the main sweep runs or is triggered after the end of holdoff.

ONESTART—When this parameter is on, the first start event starts a counter into an endless loop. The count event is the clock source, and the holdoff value is the number of events to count per cycle. When a count cycle is ended, the Main Sweep can be triggered or run, depending on the mode if ready.

When the parameter is off, operation is identical, except that each start event increments the counter once, rather than triggering an endless loop.

COUNT—selects the "Count" event, which acts as the clocking source.

START—selects the "Start" event after which the counting cycle begins.

HOCOUNTDOWN Command

This "set only" command sets the number of events to advance or retreat from the present trigger event. This movement from the present trigger event to a new trigger event is done by changing the "HOLDOFF COUNTDOWN" value by the "NEXT" or "PREVIOUS" amount for one count cycle only, which lengthens or shortens the Main Sweep holdoff time for one cycle. After the single altered cycle, the holdoff count is returned to the "HOLDOFF COUNTDOWN" value.

Parameters:

The maximum count capacity is $(2^{29})-1$. Therefore, the combined "HOLDOFF COUNTDOWN" value and the incremental or decremental value of "NEXT" or "PREVIOUS" must not be less than 2 or greater than $(2^{29})-1$.

Query Information

The general query forms are `HOLDOFF?` or `HOEVENT?`. Each general query returns all of its links and the current arguments (e.g., `HOLDOFF [<link>:<arg>] [{, <link>:<arg>} . . .]`). Hence, links can be individually specified (e.g., `HOLDOFF? TIME`).

Examples of queries and related responses follow:

HOLDOFF?

HOLDOFF TIME:0,STEP2NS:69.61E-6,
COUNTDOWN:2,EVENT:2,TYPE:TIME

HOEVENT?

HOEVENT MODE:RUNS,ONESTART:OFF,COUNT:STEP2NS,
START:MAINTRIG

Waveform Commands

The commands shown in Table 3-27 are used to create and vertically position waveforms on the crt.

TABLE 3-27
Waveform and Settings Commands

Header	Link	Argument	Range	Resolution
TRACE<ui>	DESCRIPTION UNITS VPOSITION HPOSITION	<trace exp> <qstring>(query only) <NRx> <NRx>	-4 to +4 -4 to +4	0.01 0.01
SELECT		TRACE<ui> TRNEXT		
CLEAR		TRACE<ui> ALL		
TRACE? (query only)				

The definition of a trace expression is shown below:

<trace exp>	::= <scope trace> <counter view trace> <reference trace> <delayed trace> UNDEF
<scope trace>	::= <vexpr> [VS <hexpr>]
<counter view trace>	::= <counter view channel>
<reference trace>	::= <reference channel> [VS <reference channel>]
<delayed trace>	::= <parent trace> VS <window>
<window>	::= WIN1 WIN2
<vexpr>	::= [<oper>]<v compartment><ch> [<oper> <v compartment><ch>]
<hexpr>	::= [<oper>]<h compartment><ch> [<oper> <h compartment><ch>]
<counter view channel>	::= COUNTIN GATE SYNCGATE AEXT BEXT
<reference channel>	::= STO1 STO2
<parent trace>	::= TRACE<trace num>
<oper>	::= + -
<v compartment>	::= L C
<h compartment>	::= C R
<ch>	::= 1 2 3 4
<trace num>	::= 1 2 3 4 5 6 7 8

TRACE<ui> Command

This command defines the various attributes of the selected trace.

Parameters:

DESCRIPTION—is used to create new waveforms. See the definition of <trace exp> for more detail. Windows must be made from previously defined traces. When TRACE is queried, the order of output ensures that windows are not created before the main trace window.

UNITS—This query-only link returns the label displayed on the crt for the waveform units. If the waveform is made up of more than a single channel and the units or scaling of all components of the waveform are not identical, the units are displayed simply as "div."

VPOSITION—sets the vertical position of the indicated trace to the specified argument. The implied units are divisions.

HPOSITION—sets the horizontal position of the indicated XY trace to the indicated argument. This command is for XY traces only.

SELECT Command

This command enables the user to select traces and sequence through previously defined traces.

Parameters:

TRNEXT—selects the next defined trace as the currently selected trace.

TRACE<ui>—selects the trace indicated by the argument as the currently selected trace. Attempting to select an undefined trace invokes an execution error.

Waveform Commands

The commands shown in Table 3-27 are used to create and vertically position waveforms on the crt.

TABLE 3-27
Waveform and Settings Commands

Header	Link	Argument	Range	Resolution
TRACE<ui>	DESCRIPTION UNITS VPOSITION HPOSITION	<trace exp> <qstring>(query only) <NRx> <NRx>	-4 to +4 -4 to +4	0.01 0.01
SELECT		TRACE<ui> TRNEXT		
CLEAR		TRACE<ui> ALL		
TRACE? (query only)				

The definition of a trace expression is shown below:

<trace exp>	::= <scope trace> <counter view trace> <reference trace> <delayed trace> UNDEF
<scope trace>	::= <vexpr> [VS <hexpr>]
<counter view trace>	::= <counter view channel>
<reference trace>	::= <reference channel> [VS <reference channel>]
<delayed trace>	::= <parent trace> VS <window>
<window>	::= WIN1 WIN2
<vexpr>	::= [<oper>]<v compartment>[<ch>] [<oper> <v compartment>[<ch>]]
<hexpr>	::= [<oper>]<h compartment>[<ch>] [<oper> <h compartment>[<ch>]]
<counter view channel>	::= COUNTIN GATE SYNCGATE AEXT BEXT
<reference channel>	::= STO1 STO2
<parent trace>	::= TRACE<trace num>
<oper>	::= + -
<v compartment>	::= L C
<h compartment>	::= C R
<ch>	::= 1 2 3 4
<trace num>	::= 1 2 3 4 5 6 7 8

TRACE<ui> Command

This command defines the various attributes of the selected trace.

Parameters:

DESCRIPTION—is used to create new waveforms. See the definition of <trace exp> for more detail. Windows must be made from previously defined traces. When TRACE is queried, the order of output ensures that windows are not created before the main trace window.

UNITS—This query-only link returns the label displayed on the crt for the waveform units. If the waveform is made up of more than a single channel and the units or scaling of all components of the waveform are not identical, the units are displayed simply as "div."

VPOSITION—sets the vertical position of the indicated trace to the specified argument. The implied units are divisions.

HPOSITION—sets the horizontal position of the indicated XY trace to the indicated argument. This command is for XY traces only.

SELECT Command

This command enables the user to select traces and sequence through previously defined traces.

Parameters:

TRNEXT—selects the next defined trace as the currently selected trace.

TRACE<ui>—selects the trace indicated by the argument as the currently selected trace. Attempting to select an undefined trace invokes an execution error.

CLEAR Command

This command removes the trace indicated by the argument from the crt. CLEAR ALL deletes all traces defined in the instrument. Attempting to clear an undefined trace invokes an execution error.

Query Information There are three forms of the TRACE? query:

TRACE? TRACE<ui>? TRACE<ui>?<link>[,<link>...]

The first form returns all links and respective values of "defined" traces only, as follows, but not necessarily in numerical order:

```
CLEAR ALL; TRACE1 <link>:<arg>[{,<link>:<arg>}...]
                (...)
```

```
TRACE8 <link>:<arg>[{,<link>:<arg>}...]
```

Note that the first form has a prepended CLEAR ALL.

The second form of the query returns only the subset of the above response related to the trace number indicated in the header (without a CLEAR ALL).

The third form of the query returns only the subset of the above response related to the trace number and indicated links (again, without a CLEAR ALL).

Use caution when sending query information back to the 11301/11302. Only TRACE?, the first form of the query, results in the total re-creation of all of the traces. Using TRACE<ui> can conflict with an existing trace of the same number.

If a trace is undefined (unused trace number), the link argument UNDEF is returned with the DESCRIPTION link (example: TRACE8 DESCRIPTION:UNDEF). UNIT is set to divs, and POSITION is set to 0.

Since the response from a query can be returned to the oscilloscope in command form, "as is," the mainframe interprets a "TRACE<ui> DESCRIPTION:UNDEF[{,<link>:<arg>}...]" command as "CLEAR TRACE<ui>".

SELECT? is the only form of this query, which returns "SELECT TRACE<ui>" where "TRACE<ui>" is the currently selected trace.

Examples of queries and related responses follow:

```
TRACE1?
```

```
TRACE1 DESCRIPTION:L1,VPOSITION:0,HPOSITION:0,UNITS:"V"
```

TRACE?

```
CLEAR ALL;TRACE2 DESCRIPTION:L1,VPOSITION:0,HPOSITION:0,UNITS:"V";

TRACE7 DESCRIPTION:L2,VPOSITION:0,HPOSITION:0,UNITS:"V";
TRACE1 DESCRIPTION:L3,VPOSITION:0,HPOSITION:0,UNITS:"V";
TRACE3 DESCRIPTION:L4,VPOSITION:0,HPOSITION:0,UNITS:"V";
TRACE5 DESCRIPTION:COUNTIN,VPOSITION:0,HPOSITION:0,UNITS:"V";
TRACE6 DESCRIPTION:GATE,VPOSITION:0,HPOSITION:0,UNITS:"V";
TRACE4 DESCRIPTION:SYNCGATE,VPOSITION:0,HPOSITION:0,UNITS:"V";
TRACE8 DESCRIPTION:STO1,VPOSITION:0,HPOSITION:0,UNITS:"V"
```

Note that the response is not necessarily in numerical order of traces.

General Information

Execution warnings are issued for out-of-range arguments for VPOSITION and HPOSITION. An illegal DESCRIPTION argument causes a syntax error. An unattainable DESCRIPTION argument causes a command error.

Permissible <ui> arguments for TRACE<ui> link are 1 through 8. Others invoke command errors:

Additional Constraints

For the purposes of this discussion let:

```
<x compartment> ::= <v compartment> | <h compartment> and
<xexpr> ::= <vexpr> | <hexpr>
```

NOTE

Except for the last constraint remark (which refers to all existing traces), the following constraints refer to only one trace expression.

In this case:

1. <ch> must be omitted if the <x compartment> that precedes <ch> holds a non-11000-series plug-in. In this case, the <oper> that precedes <x compartment> cannot be "-".
2. A unique {<x compartment><ch>} combination may appear only once in <xexpr>.
3. <v compartment> may never equal <h compartment>.
4. Both values of <h compartment> (if there are two) must be identical.
5. The value "UNDEF" causes the trace to be deleted.
6. If <trace exp> consists of <delayed trace>, then the value of <trace num> must not be the same value as <ui>.

7. If <trace exp> consists of <delayed trace>, then the trace referred to by <parent trace> must be a previously defined trace that does not have <delayed trace> or <reference trace> as part of its <trace exp>.
8. Some values of <ch> are not always valid, depending on the current plug-in configuration. For example, "3" and "4" are not valid if the plug-in is a two-channel plug-in.
9. All instances of <h compartment> in all trace expressions must have identical values.

Window Delay Commands

The commands shown in Table 3-28 are used to set delay parameters for windows (delayed sweeps).

TABLE 3-28
Window Delay Commands

Header	Link	Argument	Range	Resolution
WIN1 WIN2	DELAY	<NRx>	0 to 10(main time/div)	(Time/div)/2000
WIN? (query only)				

WIN1 & WIN2 Commands

These commands set the actual delay to a value designated by the argument of whichever function is chosen. If in trig'd after delay, the delayed sweeps do not accept a valid trigger until after the delay value has been met.

Parameters:

DELAY—sets the amount of time that must elapse before the delayed sweep can run (or trigger). The units are seconds.

Query Information

The general query form is WIN1? or WIN2?. This form returns the link and its current arguments (an <NR3> number). The query link can be specified.

WIN?—is a special query-only short-hand way of giving the WIN1 and WIN2 commands (WIN1?;WIN2?) all at once.

Examples of queries and related responses follow:

WIN1?

WIN1 DELAY:10.000E-6

WIN2?

WIN2 DELAY:40.000E-6

Window Trigger Commands

The command shown in Table 3-29 is used to qualify the delayed time-base trigger.

TABLE 3-29
Window Trigger Command

Header	Link	Argument
WTMODE	MODE:	RUNS TRIGGER

WTMODE Command

This command interacts with the previous window commands to enable the mode of delayed traces.

Parameters: **MODE**—sets the trigger to either "runs after delay" or "triggered after delay" mode.

Query Information The general form WTMODE? returns the link and its value. The query links can be specified.

WTMODE?

WTMODE MODE:RUNS

Abbreviating Command Set Words

When transmitting an abbreviated command word or verb (command set mnemonic) to an ASCII port of the oscilloscope, at least the minimum number of letters of each word must be used before the word can be recognized.

SCREEN is recognized as

SCREEN, SCREE, SCRE, SCR

but not recognized or legal as:

SC or S

Symbols three or fewer characters long are not abbreviated, e.g., UID is only recognized and legal as UID, not as UI or U.

A few often-used symbols are abbreviated shorter than needed to differentiate them from other symbols. For these symbols, the minimum defined abbreviation is legal, intermediate abbreviations may be illegal, and any letters beyond the minimum set are acceptable as part of the word. For example:

INTENSITY can be abbreviated as:

INTENSITY, INTENSIT, INTENSI, INTENS, INTEN, INTE, and INT;

INTERNAL can be abbreviated to

INTERNAL, INTERNA, INTERN, and INTER;

but INT is a valid abbreviation for INTENSITY even though it appears to conflict with INTERNAL.

Figure 3-13 shows examples of valid commands with and without command word abbreviations. The left column lists unabbreviated commands, and the right column lists the corresponding command in its most abbreviated form.

<u>NONABBREVIATED COMMAND</u>	<u>FULLY ABBREVIATED COMMAND</u>
TRACE1 DESCRIPTION: L1	TRA1 DES: L1
TBMAIN? TIME	TBM? TIM
DISPLAY VECTORS	DISP VEC
TRMAIN LEVEL:1.2;TRMAIN?	TRM LEV:1.2;TRM?

6106-399

Figure 3-13. Examples of valid commands with and without abbreviations.

Table 3-30 contains a complete listing of command words. The abbreviation of each word is indicated with capital letters.

TABLE 3-30
Command Word Abbreviations

ABSolute	CHL1	DOTs
ABStouch	CHL2	DSR
AC	CHL3	DT
ACHf	CHL4	DUTy
ACLf	CHOP	
AEXt	CHR	ECHo
ALL	CHR1	EMPTy
ALLEV	CHR2	ENCdg
ALternate	CHR3	ENHanced
AMPLitude	CHR4	EOL
ASCii	CLEAr	ERASe
ATotal	CMDerr	EVEN
ATTN	CONFig	EVENT
AUTO	CONTRast	EVQty
AUTOCAL	COOrd	EXErr
AUTOmeasure	COUNT	EXT
AUTOSet	COUNTDown	EXT/5
AVErages	COUNTIn	EXT10mhz
	COUPling	EXTENded
BAUd	CR	EXWarn
BEXt	CRLf	
BINary	CRVchk	FAStrise
BIT/nr	CTCLOCK	FLAgging
BN.fmt	CTFrequency	FORce
BOTH	CTMeas	FPAnel
BREak	CTPeriod	FPNext
BTOtal	CTRAtio	FPS0
BWHi	CTRESET	FPS1
BWLo	CTRESULT	FPS2
BYT/nr	CTS	FPS3
	CTTIme	FPS4
C	CTTOtal	FPS5
C1	CTWidth	FPS6
C2	CURSor	FPS7
C3	CURVe	FPS8
C4		FPS9
CALDue	D1Total	FREquency
CALibrator	DAC	
CALStatus	DATE	GATE
CENter	DATIme	GATing
CH	DB	GPIb
CHARACTER	DC	GRaticule
CHARBits	DCHf	
CHC	DEBug	H12
CHC1	DEGree	H1Abs
CHC2	DELAy	H1Rel
CHC3	DEScRiption	H24
CHC4	DISPlay	H2Abs
CHKsm0	DIV	H2Rel
CHL	DLY1	HARD
	DLY1Trig	HARDLine
	DLY2Trig	HCursor
	DLYTrig	HDElta

TABLE 3-30 (cont)
Command Word Abbreviations

HELp	NEWconfig	SLOpe
HIGH	NEXt	SOFT
HO	NONe	SOURce
HOCountdown	NORm	SPEaker
HOEvent	NR.pt	SQUare
HOLdoff	ODD	SRQ
HORizontal	OFF	SRQMask
HPOsition	OFFSet	SSEq
HREF	ON	STARt
ID	ONEstart	STByte
IDProbe	OPCmpl	STEp2ns
IMPedance	OUTput	STO1
INErr	PARity	STO2
INIt	PASsed	STOP
INPut	PERCent	STOPBits
INTensity	PERiod	STORe
INTERnal	PLScoupling	STRing
INWarn	PLSOffset	SWEEPS
L	PLUs	SWP
L1	POsition	SWPGate
L2	POWeron	SYNcgate
L3	PP	TBDelay
L4	PREvious	TBDisplay
LEFT	PROBe	TBGateout
LEVel	PT.fmt	TBMain
LF	R	TERMinal
LFCr	R1	TESt
LINE	R2	TEXT
LONGform	R3	TIME
LOUD	R4	TOTAL
LOW	RATio	TR
MAGnifier	RDY	TR1Delay
MAIN	RECall	TR2Delay
MAINTrig	REDirect	TRAcE
MANual	REFerence	TRAcE1
MAXimum	RELative	TRAcE2
MBExt	RESet	TRAcE3
MDTrig	RI	TRAcE4
MEAS	RIGHT	TRAcE5
MEASUre	ROCs	TRAcE6
MEDium	RQS	TRAcE7
MIDDLE	RS232	TRAcE8
MINimum	RUNS	TRAcKing
MINUs	SCALE	TRAExt
MNScoupling	SCReen	TRBExt
MNSOffset	SELEct	TREset
MNTouch	SELFcal	TRIGger
MODE	SENsitivity	TRMain
MSLIst	SEQuence	TRNext
MTOtal	SET	TYPE
MUX		

TABLE 3-30 (cont)
Command Word Abbreviations

UID	VO	Y
UNDef	VPOsition	YMUlt
UNEnhanced	VREF	YUNit
UNIts	VS	YZEro
UPDate		
UPTime	WARmup	
USEr	WAVfrm	
	WFId	
V1Abs	WFMpre	
V1Rel	WIDth	
V2Abs	WIN	
V2Rel	WIN1	
VC	WIN2	
VCOffset	WTMode	
VCUrsor	X	
VDElta	XINcr	
VECTors	XMUlt	
VERSIon	XUNit	
VERTical	XY	
VIEW	XZEro	

Character Set

Table 3-31 lists the set of nonescaped characters that can be displayed on the oscilloscope screen. Table 3-32 lists the set of escaped characters that can be displayed on the display. Escaped characters are formed by concatenating an ASCII escape character (decimal 27) with some other ASCII character, as shown in the tables in this section. The following GPIB command places an integral math symbol on the display (HP200/300 series, 1130X address = 1):

```
OUTPUT 701; "TEXT STRING:"";CHR$(27);"d"""
```

TABLE 3-31
ASCII Character Set

	0	1	2	3	4	5	6	7
0	0	16	32	48	64	80	96	112
1	1	17	33	49	65	81	97	113
2	2	18	34	50	66	82	98	114
3	3	19	35	51	67	83	99	115
4	4	20	36	52	68	84	100	116
5	5	21	37	53	69	85	101	117
6	6	22	38	54	70	86	102	118
7	7	23	39	55	71	87	103	119
8	8	24	40	56	72	88	104	120
9	9	25	41	57	73	89	105	121
A	10	26	42	58	74	90	106	122
B	11	27	43	59	75	91	107	123
C	12	28	44	60	76	92	108	124
D	13	29	45	61	77	93	109	125
E	14	30	46	62	78	94	110	126
F	15	31	47	63	79	95	111	127

TABLE 3-32
Escaped Character Set

	0	1	2	3	4	5	6	7
0	0 Æ	16 Ñ	32	48	64	80 π	96 ↓	112 -
1	1 å	17 Ñ	33	49	65 α	81 ø	97 ↑	113 -
2	2 Ö	18 ð	34	50	66	82 ρ	98 →	114 -:
3	3 ö	19 ï	35	51	67 δ	83 Σ	99 ←	115 →
4	4 Ü	20 ã	36	52	68 Δ	84 τ	100 ∫	116 ←
5	5 ü	21 ã	37	53	69	85	101 ÷	117 °
6	6 à	22 À	38	54	70 ø	86 v	102 °	118 ¹
7	7 è	23 Æ	39	55	71 Γ	87 ω	103 √	119 ²
8	8 á	24 ø	40	56	72	88	104	120 ³
9	9 é	25 É	41	57	73	89	105 ±	121 ⁴
A	10 Å	26 Ø	42	58	74	90	106 ≠	122 ⁵
B	11 å	27 ø	43	59	75	91	107 ≤	123 ⁶
C	12 Æ	28 Œ	44	60	76	92	108 ≥	124 ⁷
D	13 æ	29 œ	45	61	77 μ	93	109 ©	125 ⁸
E	14 ç	30 Ç	46	62	78	94 σ	110 ₣	126 ⁹
F	15 ß	31 ∞	47	63	79 Ω	95	111 ≈	127 ¹⁰

Status and Event Reporting

Through the service request function, the 11301/11302 can report operating status to the controller. Likewise, this function can aid in debugging and in high-level troubleshooting.

Using SRQ with IEEE-488

The SRQ line is one of eight control lines defined in the IEEE-488 standard. When that line is asserted by any device, the controller performs a serial poll to determine which of the connected devices asserted the SRQ line. This poll consists of reading a special byte from each instrument (known as a Status Byte), which is decoded to determine the status of each device.

Using SRQ with RS-232-C

Since RS-232-C specifies a serial format, there is no separate line for the SRQ. So in lieu of a serial poll, when the 11301/11302 sends an SRQ to the RS-232-C controller, the controller sends a status byte query (STBYTE?) to the oscilloscope to determine its status.

Masking and Controlling Requests

Two commands control the instrument ability to request service: RQS and SRQMASK. These are independently controlled by each port, so that, for example, the RS-232-C RQS can be on when the GPIB RQS is off.

RQS Command

The RQS command enables all service requests. The oscilloscope always generates an SRQ when it powers up. In this way, the instrument reports availability for bus transactions. If the oscilloscope fails power-up diagnostics, it reports a "self test failure" event. The controller can then use the event query system to determine the fault more precisely.

The RQS command is accepted at both the GPIB and RS-232-C ports, and affects event reporting at both ports, independently. RQS has two major functions:

1. It controls bit DIO7 of the status byte. The command "RQS ON" enables DIO7 assertion. The command "RQS OFF" disables assertion for all conditions except "Power On." At instrument power up, RQS is ON at both the GPIB port and the RS-232-C port.
2. This command also controls whether the oscilloscope is permitted to request service from a GPIB controller. The command "RQS OFF" disables service requests. The command "RQS ON" enables service requests.

When RQS is ON, the oscilloscope is enabled to asynchronously report events. When RQS is OFF, this function is disabled, and the oscilloscope cannot report events. Thus, a GPIB controller is not asynchronously informed (via SRQ) that an event has occurred. A controller may still interrogate the oscilloscope via an IEEE-488 serial poll or STBYTE? for RS-232-C to read the most recent status byte.

If RQS is on and the USER SRQMASK is enabled, the front-panel RQS button causes the oscilloscope to generate an SRQ. The SRQ light turns on whenever the oscilloscope generates an SRQ (see Fig. 3-14).

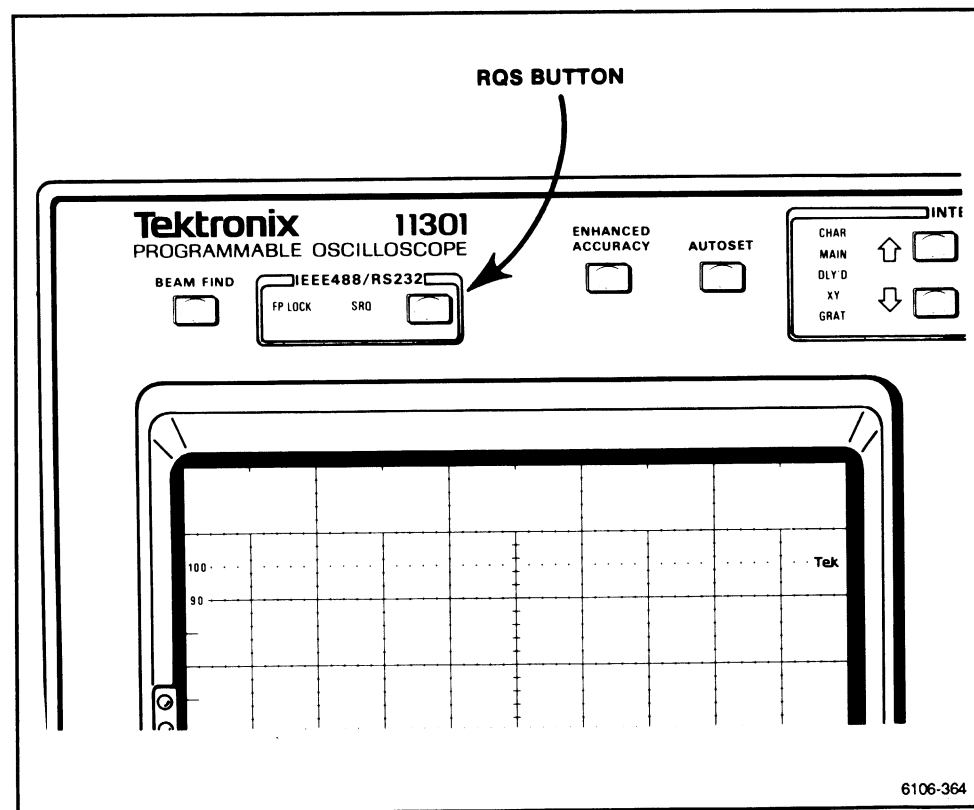

Figure 3-14. RQS/SRQ Button and Light On the oscilloscope Front Panel.

SRQMASK Command

The SRQMASK command is provided to disable (mask off) classes of events. (For the list of event classes and the syntax of the SRQMASK command, see its description earlier in the Command Set.) Note, however, that even if an event class is enabled, no events are reported if RQS is off. The SRQMASK command has ten associated links, each of which specify an event class that can be selectively masked:

- CMDERR
- EXERR
- INERR
- EXWARN
- INWARN
- OPCMPL
- USER
- IDPROBE
- CALDUE

The oscilloscope powers up with the IDPROBE, and USER, masks disabled, but with the other masks enabled. Note that when a mask is on, the service requests related to that mask are enabled. Note also that a mask is effective when an event is reported, not just when generated. That is, if the SRQMASK for an event is off when the event code is generated, the event code is discarded. Further, if the SRQMASK is on when the event is generated, then turned off before the event is queried, the event is discarded.

Each of the SRQMASK commands relate to a particular status byte. This is shown in the tables that list event codes, later in this section.

Event Reporting

The second part of the 11301/11302 status reporting system is event code reporting. Compared to the status byte system, oscilloscope event codes more precisely report the equipment condition.

GPIB/RS-232-C controllers can read event codes via a device dependent EVENT? query. The response to an EVENT? query is either:

EVENT <NR1>

- or -

EVENT <NR1>, <qstring>

<NR1> represents the numerical value of an event code, and <qstring> is a quoted string that describes the returned event code.

The second response with the quoted description string is returned only when the LONGFORM is ON.

See the command set description of the EVENT? command and the LONGFORM command for related information.

Event Handling

Oscilloscope events are based on the same classes of status conditions as the service request system. Event handling while in RS-232-C or GPIB is much the same, with minor exceptions. The GPIB uses "EVENT?", a serial poll, and the SRQ line for event-handling transactions. Since the last two are not available on the RS-232-C, "STBYTE?" emulates the serial poll. See Figure 3-15 for a flow diagram of event handling.

Reading the Event Registers

It should be noted that status bytes and event codes are paired, i.e., an event code always accompanies a status byte. Referring to Figure 3-15, note that the chain of functional blocks is one longer for the event than for the status byte. This is because of the following:

When the operator sends a status byte query, the response may or may not be of interest. If it is, the most likely next move is to query the most recent event for more precise definition of the event. But, since status bytes and event codes are paired, sending a status byte query updates both the status byte register and the event code register just when the operator has need of the corresponding event code. Thus, the Polled EC register is used to store the event code that matched the status byte last queried and cleared.

RQS OFF; Status Byte Queries

If RQS is off, a status byte query moves the current EC to the Polled register. The polled EC contents can now be read by an event query. Use caution, though, for any further status byte queries unaccompanied by event queries discard event codes, one for each status byte query.

RQS OFF; Event Queries

If RQS is off, an event query first reads from the Polled EC register, if loaded. Once again use caution, for any further event queries unaccompanied by status byte queries, discard status bytes; one for each event code.

RQS ON; Status Byte Queries

If RQS is on, a status byte query moves the current EC to the Polled register. The polled EC contents can now be read by an event query. Use caution, though, for any further status byte queries unaccompanied by event queries, discard event codes; one for each status byte query.

RQS ON; Event Queries

If RQS is on, an event query attempts to read the Polled EC. If none is present, it elicits the response:

EVENT 459, "SRQ Pending, cannot query event serial poll"

This feature helps the operator to prevent inadvertently discarding status bytes. To read the event register, turn RQS off and use the ALLEV? command. Be advised that this discards corresponding status bytes.

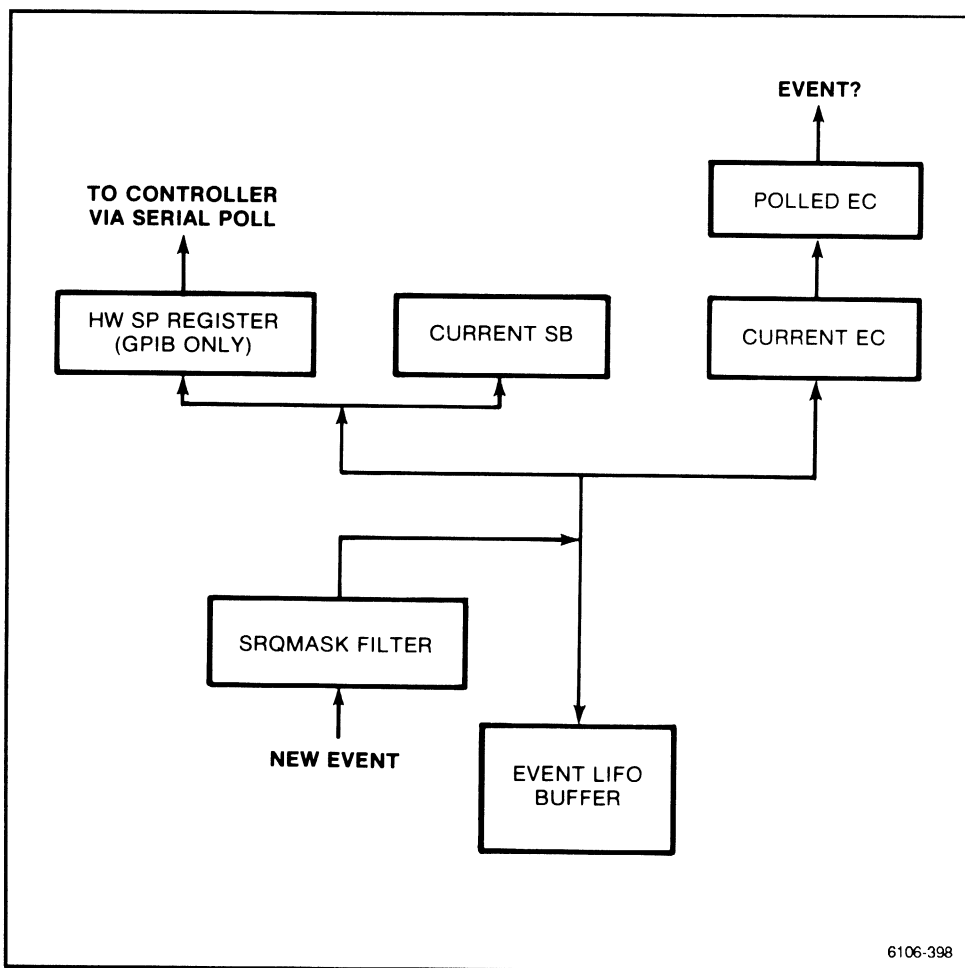

Figure 3-15. Event Handling.

SRQ Responses

SRQ responses fall into two major classes: Status Bytes and Event Codes. The first, Status Bytes, reports on the general state of the instrument, returning information like "Power On", "Execution Error", and such. The second, Event Codes, report status in much more specific terms like "168 Incomplete trigger expression aborted" or "257 Illegal waveform number".

Status Byte Definition

A Status Byte consists of eight bits of information, having the following bit assignments (bit 8 is the MSB; bit 1 is the LSB):

- Bit 8: (always 0)
- Bit 7: Request service bit (set to 1 when service is requested)
- Bit 6: Status (set to 1 when status is abnormal)
- Bit 5: Busy (set to 1 when device is busy)
- Bit 4: System status bit 4
- Bit 3: System status bit 3
- Bit 2: System status bit 2
- Bit 1: System status bit 1

The last four bits make up the status byte code that identifies each type of status reported. Overall, the value of the eight bits represents a single system status condition. Status conditions divide into two classes: abnormal (bit 6 set) and normal (bit 6 not set). The five abnormal conditions are:

1. **Command Error**—reported when a message cannot be parsed or lexically analyzed.
2. **Execution Error**—reported when a message is parsed but cannot be executed.
3. **Internal Error**—reported when the mainframe or one of the plug-in units malfunctions.
4. **Execution Warning**—reported when the oscilloscope is operating, but the user should be aware of potential problems.
5. **Internal Warning**—reported when the oscilloscope indicates that a problem has been detected. The instrument remains operational, but the problem should be corrected.

There are also five normal conditions defined:

1. **No Status To Report**—reported when there is no event or device dependent status to report.
2. **Power On**—reported when the oscilloscope has finished its power on sequence. This action informs the controller that the oscilloscope is ready for operation.
3. **Operation Complete**—tells the controller that a task has been completed.
4. **User Request**—occurs when one of the following front-panel actions is performed by the instrument operator:
 - a) Selection of the RQS front-panel button.
 - b) Pressing the ID button on a probe attached to a generic plug-in channel.
5. **Calibration Due**—reported when self-calibration is due, when calibration runs automatically, and when the 20-minute warmup period is complete. Table 3-33 lists the binary and decimal codes that correspond to the previously described conditions.

TABLE 3-33
11301/11302 Status Bytes

Condition	BINARY			DECIMAL (B=0)	
	DIO:	8765	4321	RQS ON	RQS OFF
Abnormal:					
Command Error		0R1B	0001	97	33
Execution Error		0R1B	0010	98	34
Internal Error		0R1B	0011	99	35
Execution Warning		0R1B	0101	101	37
Internal Warning		0R1B	0110	102	38
Normal:					
No Status To Report		000B	0000	0	0
Power On		0R0B	0001	65	1
Operation Complete		0R0B	0010	66	2
User Request		0R0B	0011	67	3
Calibration Due		0R0B	0110	70	6

NOTE

DIO7, shown as "R" in this table, is asserted when specifically enabled via the device dependent RQS ON command. Otherwise, the "R" bit is 0 (zero). DIO5, shown as "B" in this table, is 1 when the oscilloscope is busy.

Event Code Definition

An event code consists of sixteen bits of information: the two's complement of a number from 0 to 65535. Event codes fall into eight classes, as shown in Table 3-34:

TABLE 3-34
Event Code Classes

Event Class	Range
Command Errors	100 – 199
Execution Errors	200 – 299
Internal Errors	300 – 399
System Events	400 – 499
Execution Warnings	500 – 599
Internal Warnings	600 – 699
Device-dependent Events	700 – 799
Not used	800 – 999

Events are also classed as port-dependent events or port-independent events. A port-dependent event is generated when any of the following system status conditions occur:

- Command Error
- Execution Error
- Execution Warning

Port-dependent events are returned only to the port responsible for the event.

Port-independent events are events that are not classified as port-dependent events and are returned to both ports. A port-independent event is generated when any of the following system status conditions occur:

- Internal Error
- Internal Warning
- Power On
- Operation Complete
- User Request
- Calibration Due

Event Priorities

More than one event can occur before a GPIB or RS-232-C controller can respond to a service request. Thus, the 11301/11302 uses the priorities shown in Table 3-35 to report events:

TABLE 3-35
Event Priority

Priority	Event Class
1	Power On
2	Command Error
2	Execution Error
2	Execution Warning
2	Internal Error
2	Internal Warning
2	Calibration Due
2	Operation Complete
3	No Status To Report

Event Codes

Tables 3-36 through 3-41 list the 11301/11302 event codes and event code description strings for all event classes.

TABLE 3-36
Command Errors

Event Code	SRQMASK	Status Byte (not Busy)		Event Code Description String
		RQS ON	OFF	
101	CMDERR	97	33	Invalid command header
102	CMDERR	97	33	Invalid header delimiter
103	CMDERR	97	33	Invalid command argument
104	CMDERR	97	33	Invalid argument delimiter
105	CMDERR	97	33	Numeric argument expected, not received
106	CMDERR	97	33	Missing argument
107	CMDERR	97	33	Invalid delimiter
108	CMDERR	97	33	Checksum error in binary block transfer
109	CMDERR	97	33	Incorrect byte count value on a binary block transfer
151	CMDERR	97	33	Symbol or number too long
152	CMDERR	97	33	Invalid or out-of-range input character
153	CMDERR	97	33	Invalid escape sequence
154	CMDERR	97	33	Invalid number input
155	CMDERR	97	33	Invalid string input
156	CMDERR	97	33	Unknown symbol
157	CMDERR	97	33	Syntax error
158	CMDERR	97	33	Invalid EOI
160	CMDERR	97	33	Expression too complex
161	CMDERR	97	33	Too many binary points
162	CMDERR	97	33	Too many ASCII points
165	CMDERR	97	33	Numerical overflow
166	CMDERR	97	33	Numerical underflow
167	CMDERR	97	33	Function not available to External Port
168	CMDERR	97	33	Incomplete trigger expression, aborted

TABLE 3-37
Execution Errors

Event Code	SRQMASK	Status Byte (not Busy)		Event Code Description String
		RQS ON	OFF	
203	EXERR	98	34	I/O buffers full, output flushed
205	EXERR	98	34	Argument is not executable
206	EXERR	98	34	Signal amplitude too small
207	EXERR	98	34	Signal amplitude too large
208	EXERR	98	34	Vertical signal not found
209	EXERR	98	34	Horizontal signal not found
210	EXERR	98	34	Cannot autoset, trace not available
211	EXERR	98	34	Cannot autoset this type of trace
212	EXERR	98	34	Cannot autoset with empty slots
213	EXERR	98	34	Cannot autoset, channel not available
214	EXERR	98	34	Autoset is disabled
225	EXERR	98	34	Delayed trigger source #1 has been changed
226	EXERR	98	34	Channel is not displayed
231	EXERR	98	34	DLY1 or DLY2 required to view intensified zones
232	EXERR	98	34	Invalid trigger source description
233	EXERR	98	34	Invalid trace description
234	EXERR	98	34	Cannot measure counter or reference view traces
235	EXERR	98	34	Measurement list is empty
236	EXERR	98	34	Enhanced Accuracy available after warmup in %a min
243	EXERR	98	34	Function disabled by hardware strap
250	EXERR	98	34	No trace currently defined
251	EXERR	98	34	Illegal trace number specified
252	EXERR	98	34	Illegal settings number specified
254	EXERR	98	34	Error in recalling stored setting
257	EXERR	98	34	Illegal waveform number
259	EXERR	98	34	Illegal number of points designator
263	EXERR	98	34	Illegal channel specified
265	EXERR	98	34	Illegal date/time argument
267	EXERR	98	34	Query response too long, truncated
272	EXERR	98	34	Function not supported by plugin
275	EXERR	98	34	%B plugin does not support CH%b command
276	EXERR	98	34	%B compartment not loaded with 7K plug-in amplifier
277	EXERR	98	34	Maximum number of traces already defined
278	EXERR	98	34	Main and window trace numbers cannot be the same

TABLE 3-37 (cont)
Execution Errors

Event Code	SRQMASK	Status Byte (not Busy)		Event Code Description String
		RQS ON	OFF	
279	EXERR	98	34	Window trace requires a main (parent) trace
280	EXERR	98	34	Cannot create a window from a window trace
281	EXERR	98	34	Cannot create a window from a reference trace
282	EXERR	98	34	Cannot select an undefined trace
283	EXERR	98	34	Trace does not exist
284	EXERR	98	34	Requested coupling not available on %b %a
285	EXERR	98	34	Requested impedance not available on %b %a
286	EXERR	98	34	Delayed trigger source #2 has been changed
287	EXERR	98	34	Delayed trigger sources #1 and #2 have been changed
288	EXERR	98	34	Stored setting buffer #%a is empty
290	EXERR	98	34	0 is not a legal value for set reference
291	EXERR	98	34	Delayed window required for Time A->B
292	EXERR	98	34	Start is Main Trig - One Start needs a Start Event
293	EXERR	98	34	Count event forced to Main Trig
294	EXERR	98	34	One start forced to OFF
295	EXERR	98	34	Command cannot be executed while GPIB in RWLS
296	EXERR	98	34	Undefined cell, ABSTOUCH not executed

Note: In the above table, the character % represents several possibilities:

%a represents an integer number.

%b represents the short form for the L, C, or R plug-in compartment.

%A represents the argument name.

%B represents the long form for the LEFT, CENTER, or RIGHT plug-in compartment.

TABLE 3-38
Internal Errors

Event Code	SRQMASK	Status Byte (not Busy)		Event Code Description String
		RQS ON	OFF	
301	INERR	99	35	Interrupt fault
302	INERR	99	35	System error
308	INERR	99	35	Level 2 probe checksum error on channel %b %a
351	INERR	99	35	Counter Timer phaselock loop not locked
352	INERR	99	35	Counter Timer PLL unlocked – check ext ref input
394	INERR	99	35	Self-test failure
397	INERR	99	35	Internal DAC overflow on channel %a of %B plugin

Note: In the above table, the character % represents several possibilities:

%a represents an integer number.

%b represents the short form for the L, C, or R plug-in compartment.

%A represents the argument name.

%B represents the long form for the LEFT, CENTER, or RIGHT plug-in compartment.

TABLE 3-39
System Events

Event Code	SRQMASK	Status Byte (not Busy)		Event Code Description String
		RQS ON	OFF	
400		0	0	No status to report
401		65	1	Power on initialization complete
403	USER	67	3	User requested SRQ, front panel button
457	IDPROBE	67	3	Probe %a ID button pressed on %B plugin
459				SRQ pending, cannot query event without serial poll
460	OPCMPL	66	2	Self test completed successfully
461	OPCMPL	66	2	Self calibration completed successfully
462	OPCMPL	66	2	Default initialization of scope complete
463	OPCMPL	66	2	Measurement block complete
464	OPCMPL	66	2	Autoset complete
465	CALDUE	70	6	Self calibration due

TABLE 3-39 (cont)
System Events

Event Code	SRQMASK	Status Byte (not Busy)		Event Code Description String
		RQS ON	OFF	
466	OPCMPL	66	2	Selected front panel setting #%a recalled
467	OPCMPL	66	2	Counter timer measurement aborted
468	OPCMPL	66	2	Counter timer measurement completed
470	OPCMPL	66	2	Storage in buffer #%a complete
471	CALDUE	70	6	20 minute warmup complete
472	CALDUE	70	6	Automatic Self Calibration occurring
473	CALDUE	70	6	Warmup complete. New config requires Cal. Press EA
474	CALDUE	70	6	Temp change since last Cal. Press EA to restore
476	CALDUE	70	6	Mainframe amplifier calibration failed
477	CALDUE	70	6	Left plugin calibration failed
478	CALDUE	70	6	Center plugin calibration failed
479	CALDUE	70	6	Right plugin calibration failed
480	CALDUE	70	6	Trace separation calibration failed
481	CALDUE	70	6	Trigger calibration failed
482	CALDUE	70	6	Sweep calibration failed
483	CALDUE	70	6	Sweep position calibration failed
484	CALDUE	70	6	Enhanced Accuracy requires 11000-series plugin.
485	OPCMPL	66	2	Counter Timer measurement error. Pulse too short.

Note: In the above table, the character % represents several possibilities:

%a represents an integer number.

%b represents the short form for the L, C, or R plug-in compartment.

%A represents the argument name.

%B represents the long form for the LEFT, CENTER, or RIGHT plug-in compartment.

TABLE 3-40
Execution Warnings

Event Code	SRQMASK	Status Byte (not Busy)		Event Code Description String
		RQS ON	OFF	
550	EXWARN	101	37	%A argument is out of range
551	EXWARN	101	37	Invalid setting – fp calibrator not changed
552	EXWARN	101	37	Additional measurement selection not available
553	EXWARN	101	37	Measurement not selected – no result to query
554	EXWARN	101	37	Trigger mode not single sequence – reset ignored
555	EXWARN	101	37	Source M&D1 Trig – Ext A&B can be Gate OR Source
556	EXWARN	101	37	Source is Main Trig – Cannot Gate Dly2 by Dly1
557	EXWARN	101	37	Gating is off - Ext A&B can be Gate OR Source
558	EXWARN	101	37	No probe on + channel %b%a – probe offset saved
559	EXWARN	101	37	No probe on – channel %b%a – probe offset saved
560	EXWARN	101	37	Source Dly2, for best result remove Dly1 window
561	EXWARN	101	37	Source Dly1, for best result remove Dly2 window
562	EXWARN	101	37	All front panel storage buffers are empty
563	EXWARN	101	37	Holdoff set below minimum for current Time/div
564	EXWARN	101	37	Use Norm trigger mode for best results
565	EXWARN	101	37	Holdoff by 2ns step invalid slower than 50 ms/div
566	EXWARN	101	37	Undersized number, display zero
567	EXWARN	101	37	Large negative number, display – infinity
568	EXWARN	101	37	Large positive number, display +infinity
569	EXWARN	101	37	Illegal number (NaN)
570	EXWARN	101	37	Gating is Off – Cannot Gate Dly2 by Dly1
571	EXWARN	101	37	Source M&D1, for best results remove Dly2 window
572	EXWARN	101	37	Counter timer TOTAL measurement has been stopped

Note: In the above table, the character % represents several possibilities:

%a represents an integer number.

%b represents the short form for the L, C, or R plug-in compartment.

%A represents the argument name.

%B represents the long form for the LEFT, CENTER, or RIGHT plug-in compartment.

TABLE 3-41
Internal Warnings

Event Code	SRQMASK	Status Byte (not Busy)		Event Code Description String
		RQS ON	OFF	
651	INWARN	102	38	Input channel %a overload on %B plug-in
652	INWARN	102	38	Input channel %a overdrive on %B plug-in
653	INWARN	102	38	RS232 input parity error
654	INWARN	102	38	RS232 input framing error
655	INWARN	102	38	RS232 input buffer overrun
656	INWARN	102	38	Delayed sweep missing
657	INWARN	102	38	Last setup lost. Factory defaults have been used.

Note: In the above table, the character % represents several possibilities:

%a represents an integer number.

%b represents the short form for the L, C, or R plug-in compartment.

%A represents the argument name.

%B represents the long form for the LEFT, CENTER, or RIGHT plug-in compartment.

System Performance Considerations

Know Your System

Getting optimum system performance depends on several factors:

1. What are the system requirements?
2. What are the system objectives?
3. What are the system components?

After deciding what you want from your system, then you must determine what you can expect from your chosen system. The first step is to know your system. Become very familiar with your controller, with each measurement instrument and data recorder, and with your chosen software (i.e., operating system, device drivers, etc.). Next, decide whether the GPIB or RS-232-C interface will suit your data transfer application needs.

To answer many of these questions, carefully study each of your system documents. In particular, learn about all about the command set for each instrument, and the instrument data format (e.g., ASCII and binary). Then look at how they buffer data and execute commands. This will give you direct information, or at least clues, to what are the fastest and most efficient software and hardware configurations for your application.

The GPIB and RS-232-C information from the earlier portion of this section should give you most of the reference data that you need to determine its contribution to your system performance. These are just a few things you need to learn about your system. The better you know the features and capabilities of your instruments, the better prepared you'll be to write efficient application programs.

The following text shows how to estimate a system's performance and what can be done to enhance that performance. The discussion assumes you are familiar with the basic terminology and concepts of test and measurement systems.

Estimating System Performance

There are four major components that make up the overall system performance picture (see Fig. 3-16). The sum of these components is the total time required to execute your intended function (application program).

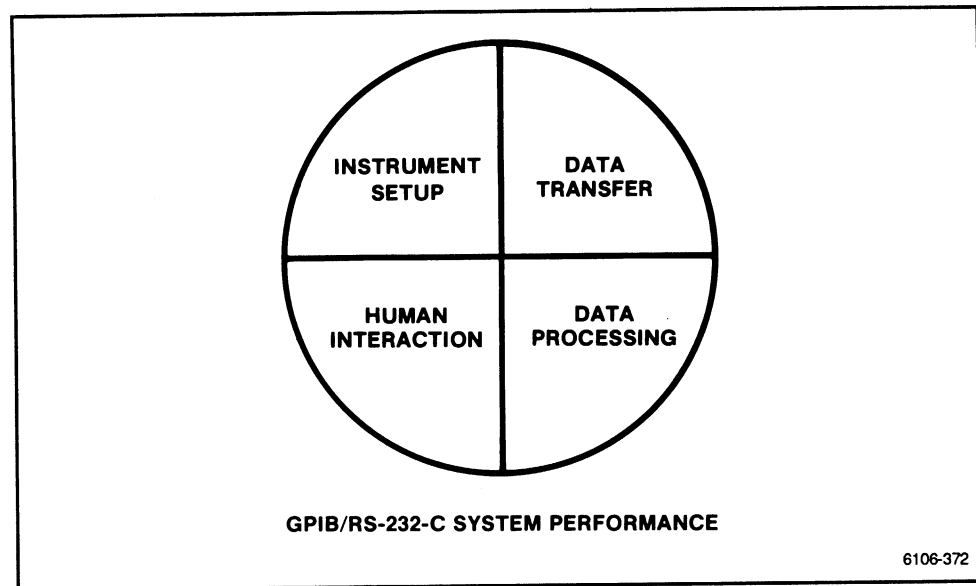

Figure 3-16. System Performance Elements.

For example, a data logging system generally spends little time setting up the instrument, and doesn't require operator intervention. Most of the time is spent acquiring and transferring the data. In contrast, a production test system may spend less time acquiring data and spend more time processing data and interacting with the operator. Each situation will result in a different focus for estimating and optimizing system performance.

Instrument Set-up Time

The first factor can be divided into two parts: the time required to decode and execute a setting command, and the time required for new settings to stabilize.

The time it takes to decode and execute a single command is usually small, but if a command initiates a complex or lengthy instrument operation, it can increase the set-up time. For instance, some commands require the oscilloscope to check to see if any of the associated settings have been changed prior to its initiation. If it finds any, then it must load the new settings into the hardware.

The second part of the set-up time is settling time, or step response time. This is the time it takes the instrument to settle to the specified parameter or data accuracy after an input or setting change. For example, when automatic scaling,

the instrument takes a reading, tests for under- or over-voltage conditions, steps the range up or down, and takes another reading. Several passes may be made until the correct range is determined. When the reading is within the newly indicated range of the input, the process stops. Remember, a change in test conditions can significantly change the set-up time.

Data Transfer Time

The second factor is the time it takes to move the data from one instrument to another. This time includes two major parameters: the number of bytes that are transferred, and the time it takes to transfer each byte.

The number of bytes transferred depends on the message being transferred (number of characters) and the message data format (e.g., ASCII or binary). The transfer rate is dependent upon the capability of the slowest device addressed on the GPIB bus (see Fig. 3-17) or just the data transfer rate of the oscilloscope and the other connected device for RS-232-C bus transfers.

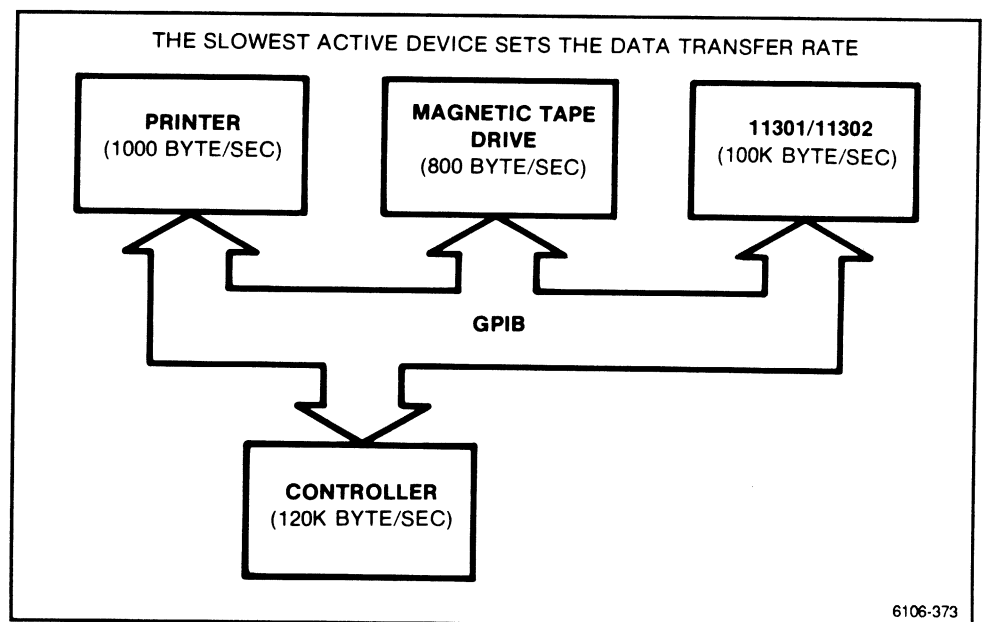

Figure 3-17. System Limitations On Data Transfer Rates.

Understanding the processing of GPIB and RS-232-C I/O statements is the key to estimating data transfer times.

The execution of GPIB I/O statements consists of five parts: statement overhead, buffer overhead, addressing sequence, data, and unaddressing sequence (see Fig. 3-18).

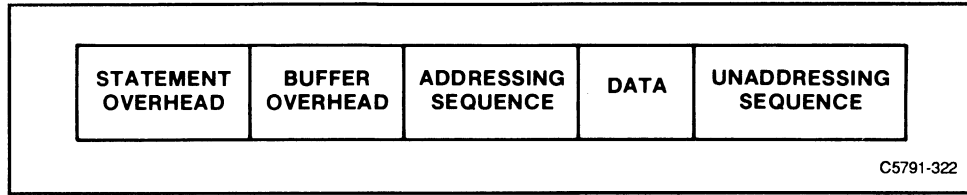

Figure 3-18. Data Transfer Time Components.

These events occur in different order, depending on whether you are dealing with an input or an output operation (see Fig. 3-19).

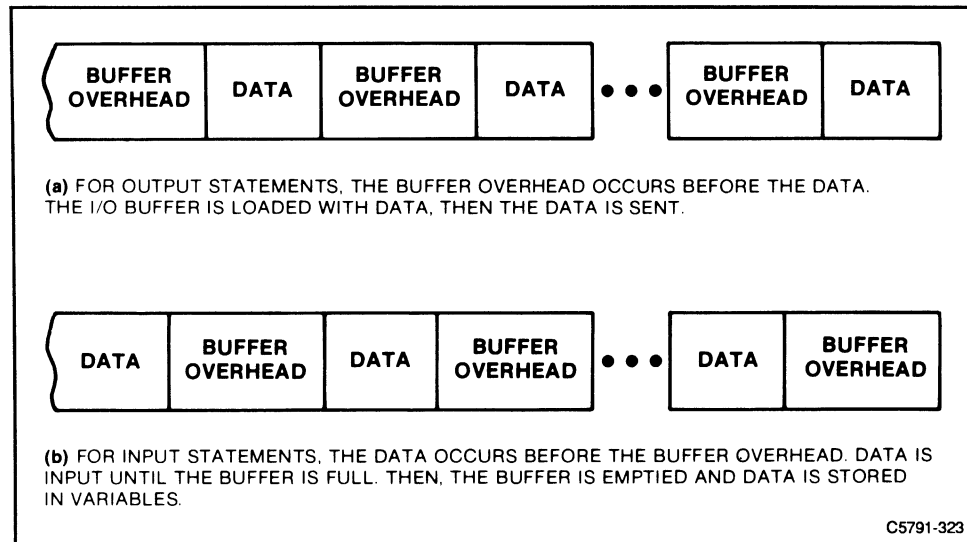

Figure 3-19. Data Input and Output Operations.

For example, statement overhead is the first processing performed when an output statement is executed (see Fig. 3-19). It consists of the time it takes to evaluate the I/O functions and other expressions of the statement, and then, the statement clauses (11301/11302 commands).

Next, the output data I/O path of the statement is set up, and an output buffer is allocated.

The time required to fill or empty the buffer is the buffer overhead. The time required for buffer overhead depends on the amount of data in the I/O buffer and the type of data; string or numeric; ASCII or binary.

The addressing sequence is the first activity on the interface bus. During this period, the oscilloscope is talk or listen addressed. This time period is dependent upon the data handshaking rate of the slowest device connected to the bus.

The data overhead is the time when device-dependent data is actually being transferred between the 11301/11302 and another device. Again, this time is dependent on the data transfer rate of the slowest device on the bus, and the amount and type (e.g., numeric arrays are a little faster than an equivalent number of scalar variables) of data being transferred. This includes the spaces and formatting characters (i.e., EOI, EOM, etc.) for each message. The total data burst time is the number of bytes being transferred divided by the data transfer rate (in bytes/second).

At the end of the data transfer messages, the controller usually performs an unaddressing sequence that untalks and unlistens all instruments on the GPIB bus to ensure a clear bus for the next transfer. This usually consists of the controller sending the untalk and unlisten addresses for each instrument on the bus.

The execution of RS-232-C I/O statements consists of five parts, somewhat similar to the GPIB. The parts are statement overhead, buffer overhead, start message, data burst overhead, and stop message. See Figure 3-20.

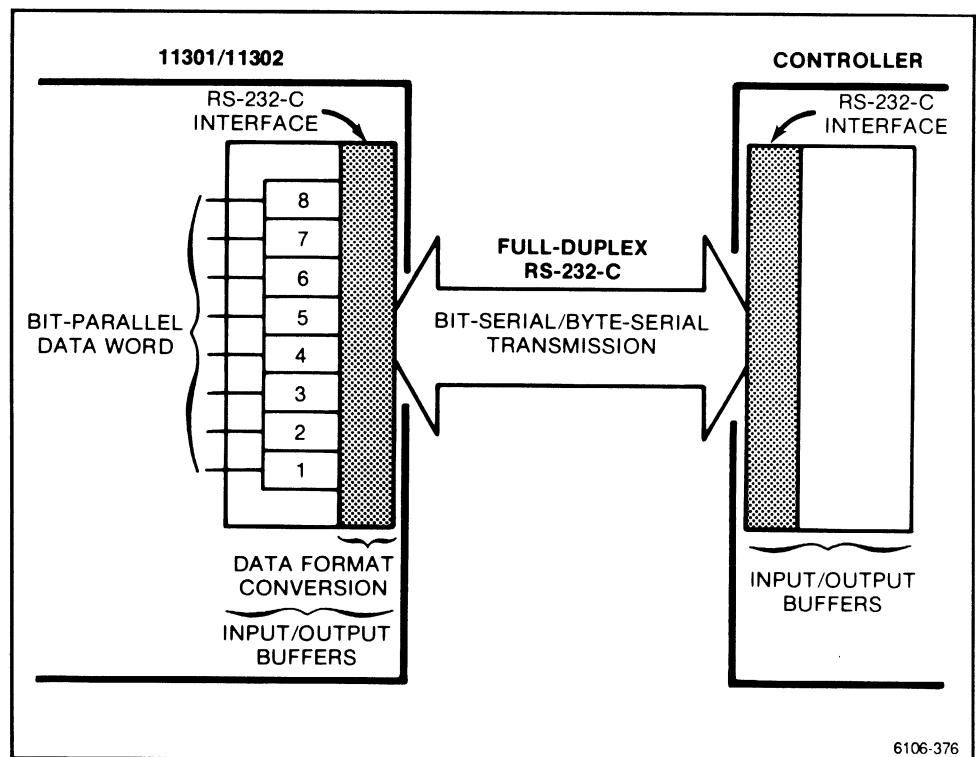

Figure 3-20. 11301/11302 RS-232-C Data Transfer.

The statement overhead consists of the same elements as the GPIB.

The buffer overhead has similar elements to the GPIB. However, since the data is sent in serial fashion over the interface bus, more time is required to convert information from serial- to-parallel, for input data, and from parallel-to-serial, for output data.

The start message time consists of the flagging or handshaking protocol and start bit.

The data burst time has similar components to the GPIB except only the sender and one receiver data transmission rates are pertinent.

The stop message time consists of the flagging protocol and the selected number of stop bits for each message.

Data Processing Time

The third factor is the time required to manipulate the acquired data to obtain a desired result.

The processing time is the time it takes the oscilloscope to manipulate the data, plus whatever time is required by the controller to further process the data (if any). The oscilloscope can deliver raw, semi-processed, or even completely processed data, depending upon the requirements of the application. The processing speed of the 11301 depends on the type or complexity of task performed, and the programming language used (high-level vs low-level).

Since processing time is difficult to estimate, often the only practical way to estimate it is by direct measurement. The real-time clock in the oscilloscope can be used for timing such measurements.

The Time command can be queried to return the time-of-day in hours, minutes, and seconds. The second parameter has a 10-millisecond resolution. As a result, for most tasks, you can directly measure execution time by putting a TIME? command before and after the code for your benchmark test.

For very short operations, where 10 ms resolution is not enough, you can perform the operation repetitively in a loop, measure the total time, and divide it by the number of iterations. Some overhead is added by the loop, but you can measure the "empty" loop overhead and subtract it from the execution time.

Human Interaction Time

The fourth and final major factor is determined by whatever operator intervention is required to enter test parameters or to make adjustments to a device-under-test (DUT).

This factor can easily become the largest part of the system total operating time. Direct measurement of this parameter is the best method of determining overhead time.

Optimizing System Performance Factors

Instrument Set-up

The key to improving instrument set-up time is to either reduce the number of setting changes or reduce the time required for the instrument to execute the setting changes.

The following suggestions can help you optimize your set-up time:

- Group the tests that use common settings.
- Set your ranges explicitly. Generally, autoranging (autoset) takes more time.
- Set up instruments that require more settling time first. While those are settling, you can be setting up other devices.
- Use internal setting storage. Resetting takes more time.
- Use low-level (i.e., low byte count and less complex) commands if provided.

Data Transfer

This can be improved in two ways: optimizing the system configuration and optimizing the programs that control the transfer.

The following suggestions are for optimizing the system configuration:

- Choose instruments that have an optimum transfer rate as near to the bus capacity as possible.
- If your controller has more than one GPIB port, use frequently interacting devices on one bus or put faster devices together on one bus.

- Be sure to unaddress slow devices when not required in the transfer.
- Again, if you have two ports, put a device-under-test (DUT) on one bus, and the test equipment on the other bus. Then, if the DUT has an error or malfunction, it won't affect the test equipment.

The following suggestions are for optimizing transfer program parameters:

- Choose the most efficient I/O statements that your controller provides. In most cases, high-level commands are fastest except where long strings are encountered. Then use low-level transfer commands (if provided).
- Minimize bus traffic by reducing the number of bytes being sent. This can be done by abbreviating command names, deleting unnecessary spaces, and omitting unnecessary zeros.
- Minimize buffer overhead. This can be done by defining buffer size (usually possible for most controllers) to accommodate the entire data transfer. You may also store the data within a string variable, since string variables store data directly from the I/O buffer, thus reducing overhead time.
- Use binary data transfers, if possible. Binary data is a little more complicated to handle than ASCII data, but binary transfers tend to be much faster since they involve fewer bytes than an equivalent ASCII transfer.

Data Processing

Faster data processing times are a result of faster algorithms and distributed processing.

The following suggestions should prove helpful:

- Evaluate the algorithms for the most efficient choice for the application and system configuration.
- Use implied array operations instead of FOR loops. This allows numeric operations to be performed much faster. The implied array operation creates temporary arrays to perform the implicit operation (e.g., add a scalar to the array) rather than an element-by-element operation.
- Select the data type carefully. Decide whether integer, short floating-point, or long floating-point operations can be done together, rather than doing mixed-mode operations that require conversion from one format to another, and take additional time.
- Evaluate your measurement needs to identify what data processing is most effectively done by which device. In other words, should the oscilloscope perform a given function on a waveform, or can the controller more quickly perform a given function.

Human Interaction

Human interaction can be the hardest component of system performance to improve. Thus, avoid human interaction as much as possible. However, the following suggestions should be helpful whenever interaction is required:

- Use programmable interfaces and switches to route signal connections whenever possible. This includes programmable relay scanners, multi-function interfaces, and signal multiplexers.
- Keep the user interface as simple as possible. The oscilloscope is especially designed for this purpose. User menus are quick and easy to use, so you can make changes fast. There is also a soft keypad for convenient setting changes. There are also complete error message and interrupt facilities, plus debug capability to help pin-point trouble areas quickly.

Programming Applications

The following programs contain a number of useful applications for the 11301/11302 GPIB and RS-232-C interfaces.

Utility Programs for HP 200 & 300 Series Controllers

These examples are for use with the HP 200 and 300 Series computers configured with a GPIB and RS-232-C interface. The programs are written in HP BASIC.

- Front-panel Settings from the 1130X—ASCII Format
- Front-panel Settings from the 1130X—Binary Format
- Automatic Measurement Operation—String Response
- Automatic Measurement Operation—Array Response
- Counter Timer Frequency Measurements
- Waveform Transfer to the 1130X—Binary Format
- Waveform Transfer to the 1130X—ASCII Format

```
100      |           ASCII Settings from 1130X Example
110      |
120      |   This program retrieves the current 1130X instrument set-up
130      |   as an ASCII string. The minimum length of this string will depend
140      |   upon the configuration of 1130X and its plug-ins.
150      |   The 1130X terminator can be set for "EOI or LF" or "EOI."
160      |
170      |   Variables used:
180      |   Scope.....is the 1130X primary device address plus 700.
190      |   Settings$...returns the entire 1130X settings.
200      |
210      |-----
220      |
230      | ASSIGN @Scope TO 701;EOL CHR$(10) END      | Set end-of-line to use EOI&LF.
240      |
250      | DIM Settings$(4000)                        | Declare and define variables.
260      |                                           | ASCII SET? returns >3000 bytes.
270      |
280      | CLEAR @Scope                               | Aborts pending or incomplete
290      |                                           | operations.
300      |
310      | OUTPUT @Scope;"ENCDG SET:ASC"              | Selects the output encoding as
320      |                                           | ASCII for all queries except
330      |                                           | waveforms.
340      |
350      | OUTPUT @Scope;"SET?"                       | Requests the 1130X settings.
360      | ENTER @Scope;Settings$                   | Enters them as Settings$.
370      | END
```

6106-377

Figure 3-21. Front-panel Settings from the 1130X—ASCII Format

```

100      Binary Settings from 1130X Example
110      !
120      ! This program retrieves the current 1130X instrument set-up
130      ! as a binary block of data as the string Settings$. The minimum
140      ! length of this string depends upon the configuration of the
150      ! 1130X and its Plus-Ins.
160      ! The 1130X terminator can be set for "EOI or LF" or "EOI."
170      !
180      ! Variables used:
190      ! Scope.....is the 1130X primary device address plus 700.
200      ! Settings...returns the entire 1130X settings.
210      !
220      ! -----
230      !
240      ASSIGN @Scope TO 701;EOL CHR$(10) END      ! Set end-of-line to use EOI&LF.
250      !
260      DIM Settings$[3000]                        ! Declare and define variables.
270      !                                          SET? returns >2000 bytes.
280      !
290      CLEAR @Scope                              ! Aborts pending or incomplete
300      !                                          operations.
310      !
320      OUTPUT @Scope;"ENCDG SET:BIN"             ! Selects the output encoding as
330      !                                          binary for all queries except
340      !                                          waveforms.
350      !
360      OUTPUT @Scope;"SET?"                       ! Requests the 1130X settings.
370      ENTER @Scope USING "-K";Settings$        ! Enters them as Settings$.
380      END

```

6106-978

Figure 3-22. Front-panel Settings from the 1130X—Binary Format.

```

100      ;           Automatic Measurement Example
110      ;           (Returns a String)
120      ;
130      ;           The program and subprogram below demonstrate how to specify
140      ;           the desired measurements, initiate them, wait for the operation
150      ;           complete interrupt, and finally how to retrieve and print the
160      ;           results. This example returns the results as an ASCII string
170      ;           called Meas$.
180      ;           The terminator of the 1130X can be set for "EOI or LF" or "EOI."
190      ;           DON'T FORGET to define and select a "Scope" trace prior to
200      ;           execution.
210      ;
220      ;           Variables used:
230      ;           Meas$....returns the entire measurement result.
240      ;           Scope.....is the 1130X device address plus 700.
250      ;           Stbyte....returns the 1130X status byte from a serial poll.
260      ;           Event.....returns the 1130X event code corresponding to the
270      ;           status byte at the time of the serial poll.
280      ;
290      ;           Subroutines called:
300      ;           Srqhandler.....services SRQ interrupts and returns Stbyte and Event.
310      ;
320      ;           -----
330      ;
340      ASSIGN @Scope TO 701;EOL CHR$(10) END      ! Set end-of-line to EOI&LF.
350      COM INTEGER Stbyte,Event,@Scope          ! Declare the variables here.
360      DIM Meas$(200)                          ! As the SRQ interrupt routine
370      !                                       cannot have passed variables,
380      !                                       they must be declared as global.
390      CLEAR @Scope                            ! Abort any pending or incomplete
400      !                                       operations.
410      !
420      OUTPUT @Scope:"ENCDG SET:ASCII"         ! Set 1130X to give ASCII responses
430      !
440      OUTPUT @Scope:"FPANEL OFF;SRQMASK OPC:ON;RQS ON"
450      !
460      !                                       This enables the 1130X interrupt
470      !                                       for Operation Complete and dis-
480      !                                       ables the front-panel controls.
490      !
500      OUTPUT @Scope:"MSLIST FREQ,PER,WID,DUTY,PP,MAX,MIDD,MINI"
510      !
520      !                                       This specifies which measurements
530      !                                       to perform.
540      !
550      ON INTR 7 CALL Srqhandler                ! Specifies the controller's action
560      ENABLE INTR 7;2                          ! and enables its spib interrupt.
570      !
580      Stbyte=0                                 ! Sets Stbyte and Event to known
590      Event=0                                  ! state.
600      !
610      OUTPUT @Scope:"AUTOMEASURE START"       ! Initiates the 1130X measurements.
620      !
630      IF Stbyte<>66 OR Event<>463 THEN 630    ! Waits until the SRQ signals that
640      !                                       the measurements have completed.
650      !                                       Stbyte=66 AND Event=463 mean that
660      !                                       the measurements are complete.
670      !
680      OUTPUT @Scope:"MEAS?"                  ! Requests the results of the 1130X
690      ENTER @Scope;Meas$                      ! and enters them as Meas$.
700      OUTPUT @Scope:"FPANEL ON"             ! Enables the 1130X front panel.
710      PRINT Meas$
720      END
730      !
740      SUB Srqhandler
750      COM INTEGER Stbyte,Event,@Scope
760      Stbyte=SPOLL(@Scope)                   ! Performs a serial poll of spib.
770      OUTPUT @Scope:"EVENT?"                 ! Requests the Event code for the
780      ENTER @Scope;Event                     ! accompanying SRQ and Stbyte.
790      ENABLE INTR 7
800      SUBEND

```

6106-379

Figure 3-23. Automatic Measurement Operation—String Response.

```

100 !           Automatic Measurement Example
110 !           (Returns an Array)
120 !
130 !           The program and subprogram below demonstrate how to specify
140 !           the desired measurements, initiate them, wait for the operation
150 !           complete interrupt, and finally how to retrieve and print the
160 !           results. This example returns the results as a REAL array
170 !           called Result(*). Output from the 1130X is always ordered as
180 !           FREQUENCY, followed by PERIOD, followed by WIDTH, followed by
190 !           DUTY, followed by PP, followed by MAXIMUM, followed by MIDDLE,
200 !           followed by MINIMUM. So, if all eight measurements are
210 !           requested, Result(0) is the Frequency, Result(1) is the Period,
220 !           Result(2) is the Width, etc.
230 !           As the numeric results can overflow when an ASCII representation
240 !           of the IEEE's "Not a Number" (NaN) is returned, an overflow trap is
250 !           necessary. The 1130X sends 2.0E308 to represent NaN.
260 !           The terminator of the 1130X can be set for "EOI or LF" or "EOI."
270 !           DON'T FORGET to have a "Scope" trace defined and selected prior
280 !           execution.
290 !
300 !           Variables used:
310 !           T$.....returns the posted time of the measurement.
320 !           D$.....returns the posted date of the measurement.
330 !           Result(*).returns the numeric results as REAL Array.
340 !           This MUST be dimensioned equal to the number
350 !           of measurements requested minus one.
360 !           (e.s. Result(7) is for eight results.)
370 !           Scope.....is the 1130X device address plus 700.
380 !           Stbyte....returns the 1130X status byte from a serial poll.
390 !           Event.....returns the 1130X event code corresponding to the
400 !           status byte at the time of the serial poll.
410 !
420 !           Subroutines called:
430 !           Srqhandler.....services SRQ interrupts and returns Stbyte and Event.
440 !
450 !-----
470 ASSIGN @Scope TO 701;EOL CHR$(10) END ! Set end-of-line to EOI&LF.
480 DIM Temp$(37) ! Declare and define variables.
490 REAL Result(7) ! Result will return 8 numbers.
500 MAT Result= (1.1E+308) ! Define some default values.
510 T$="None"
520 D$="None"
530 COM INTEGER Stbyte,Event,@Scope ! As the SRQ interrupt routine
540 ! cannot have passed variables,
550 ! they must be declared as global.
560 CLEAR @Scope ! Abort any pending or incomplete
570 ! operations.
580 !
590 OUTPUT @Scope;"ENCDG SET:ASCII" ! Set 1130X for ASCII responses.
600 !
610 OUTPUT @Scope;"FPANEL OFF;SRGMASK OPC:ON;RQS ON"
620 !
630 ! This enables the 1130X interrupt
640 ! for Operation Complete and dis-
650 ! ables the front-panel controls.
660 !
670 OUTPUT @Scope;"MSLIST FREQ,PER,WID,DUTY,PP,MAX,MIDD,MINI"
680 !
690 ! This specifies which measurements
700 ! to perform.
710 !

```

Continued

6106-380A

Figure 3-24. Automatic Measurement Operation—Array Response.

```

720 ON INTR 7 CALL Srqhandler           ! Specifies the controller's action
730 ENABLE INTR 7:2                     ! and enables its GPIB interrupt.
740 !
750 Stbyte=0                            ! Sets Stbyte and Event to known
760 Event=0                              ! state.
770 !
780 OUTPUT @Scope;"AUTOMEASURE START"   ! Initiates the 1130X measurements.
790 !
800 IF Stbyte<>66 OR Event<>463 THEN 800 ! Waits until the SRQ signals that
810 !                               ! the measurements have completed.
820 !                               ! Stbyte=66 AND Event=463 mean that
830 !                               ! the measurements are complete.
840 !
850 ON ERROR GOTO Overflow              ! Enables "Not a Number" trap.
860 OUTPUT @Scope;"MEAS?"              ! Requests the results of the 1130X
870 ENTER @Scope;Temp$,Result(*)       ! and enters them as an array.
880 OFF ERROR                           ! Disables the error trap.
890 !
900 Qloc=POS(Temp$,"")                  ! Extracts the time from the
910 T%=Temp#[Qloc+1,Qloc+8]             ! string Temp$.
920 Temp%=Temp#[Qloc+10,LEN(Temp#)]
930 Qloc=POS(Temp$,"")                  ! Extracts the date from the
940 D%=Temp#[Qloc+1,Qloc+9]             ! string Temp$.
950 !
960 Overflow: !
970 IF ERRN=19 THEN                     ! Error 19 is caused by an overflow
980 DISP "Number builder overflowed"    ! in the "Number Builder" as it
990 BEEP 80,.2                          ! attempts to convert a string
1000 END IF                              ! that is too big to disest.
1010 !
1020 OUTPUT @Scope;"FPANEL ON"         ! Enables the 1130X front panel.
1030 !
1040 PRINT TAB(21);"Time ";T%,"Date ";D% ! Prints the results.
1050 Fmt1: IMAGE 8(2X,5A,3X)
1060 PRINT USING Fmt1;"Freq","Per","Width","Duty","P-P","Max","Mid","Min"
1070 PRINT USING "M3DE,2X";Result(*)
1080 END
1090 !
1100 SUB Srqhandler
1110 COM INTEGER Stbyte,Event,@Scope
1120 Stbyte=SPOLL(@Scope)
1130 OUTPUT @Scope;"EVENT?"            ! Performs a serial poll of GPIB.
1140 ENTER @Scope;Event                ! Requests the Event code for the
1150 ENABLE INTR 7                      ! accompanying SRQ and Stbyte.
1160 SUBEND

```

6106-3808

Figure 3-24 (cont). Automatic Measurement Operation—Array Response.

```

100      Counter Timer Frequency Measurement Example
110
120      The program and subprogram below demonstrate how to
130      set up the Counter Timer for a frequency measurement, initiate it,
140      wait for the operation complete interrupt, and finally how to
150      retrieve and print the results.
160      This assumes that a valid measurement is retrievable.
170      The terminator of the 1130X can be set for "EOI or LF" or "EOI."
180
190      Variables used:
200      Result....returns the numeric result.
210      Ref.....the result is relative to this reference value.
220      Scope.....is the 1130X device address plus 700.
230      Stbyte....returns the 1130X status byte from a serial poll.
240      Event....returns the 1130X event code corresponding to the
250      status byte at the time of the serial poll.
260
270      Subroutines called:
280      Srqhandler....services SRQ interrupts and returns Stbyte and Event.
290
300      -----
310
320      ASSIGN @Scope TO 701;EOL CHR$(10) END ! Set end-of-line to EOI&LF.
330
340      COM INTEGER Stbyte,Event,@Scope      ! Declare and define variables.
350      !                                     As the SRQ interrupt routine
360      !                                     cannot have passed variables,
370      !                                     they must be declared as global.
380      CLEAR @Scope                        ! Abort any pending or incomplete
390      !                                     operations.
400
410      OUTPUT @Scope;"ENCDG SET:ASCII"      ! Set 1130X for ASCII responses.
420
430      OUTPUT @Scope;"FPANEL OFF;SRQMASK OPC:ON;RQS ON"
440
450      !                                     This enables the 1130X interrupt
460      !                                     for Operation Complete and dis-
470      !                                     ables the front panel controls.
480
490      OUTPUT @Scope;"CTFREQ AVER:0,GATING:OFF,UPDATE:MAN,SOURCE:MAINTRIG,REFE:0"
500      OUTPUT @Scope;"CTMEAS FREQ"
510
520      !                                     This specifies the set up for the
530      !                                     frequency measurement and selects
540      !                                     frequency as the measurement.
550
560      ON INTR 7 CALL Srqhandler            ! Specifies the controller's action
570      ENABLE INTR 7;2                      ! and enables its spib interrupt.
580
590      Stbyte=0                             ! Sets Stbyte and Event to Known
600      Event=0                             ! state.
610
620      OUTPUT @Scope;"CTRESET"              ! Clears/starts a new measurement
630
640      IF Stbyte<>66 OR Event<>468 THEN 640 ! Waits until the SRQ signals that
650      !                                     the measurements have completed.
660      !                                     Stbyte=66 AND Event=468 mean that
670      !                                     the measurement is complete.
680
690      OUTPUT @Scope;"CTRESULT?"            ! Requests the result of the 1130X.
700      ENTER @Scope;Result,Ref            ! Get the result and its reference.
710
720      OUTPUT @Scope;"FPANEL ON"          ! Enables the 1130X front panel.
730
740      PRINT "Frequency=";Result;"Hz", "Ref=";Ref;"Hz"
750      END
760
770      SUB Srqhandler
780      COM INTEGER Stbyte,Event,@Scope
790      Stbyte=SPOLL(@Scope)
800      OUTPUT @Scope;"EVENT?"              ! Requests the Event code for the
810      ENTER @Scope;Event                  ! accompanying SRQ and Stbyte.
820      ENABLE INTR 7
830      SUBEND

```

6106-381

Figure 3-25. Counter Timer Frequency Measurements.

```

100 !
110 !           Binary Waveform Transfer to 1130X Example
120 !
130 !   This example constructs a waveform array and transmits it to the
140 !   1130X. Although a Checksum value is computed for completeness, it is
150 !   not vital to send the correct value. However, if the wrong checksum
160 !   is sent, an execution warning will be issued but the waveform will
170 !   still be accepted. Binary encoding is used. The 1130X is expecting
180 !   two bytes for each displayed waveform array value. The first byte of
190 !   each byte-pair is interpreted as the Most Significant byte. The pair
200 !   is assumed to be 10 bits in two's complement and right-hand justified.
210 !   The terminator of the 1130X can be set for "EOI or LF" or "EOI."
220 !
230 !   Variables used:
240 !   Scope.....is the primary device address of the 1130X plus 700.
250 !   Wfm$.....is the target/destination memory(1 or 2) in the 1130X.
260 !   Curve(*)...is an integer array representing the waveform values.
270 !   Bytecount...is an integer representing the total number of bytes
280 !               in the transmission.
290 !   Checksum....is an integer representing the MOD 256 of sum of the
300 !               Curve bytes and the Bytecount bytes.
310 !
320 ! -----
330 ! ASSIGN @Scope TO 701;EOL CHR$(10) END ! Set end_of_line to use EOI&LF.
340 !
350 ! Wfm$="2"
360 !                                     ! Declare and define variables.
370 !                                     ! 1 is for ST01, 2 is for ST02.
380 ! INTEGER Curve(1023),Checksum,Bytecount
390 ! Bytecount=2049
400 ! Checksum=(SHIFT(Bytecount,8)+BINAND(Bytecount,255))
410 !
420 ! DEG
430 ! FOR I=0 TO 1023
440 !   Curve(I)=SIN(I*360/1024)*256
450 !   Msb=SHIFT(Curve(I),8)
460 !   Lsb=BINAND(Curve(I),255)
470 !   Checksum=BINAND(Checksum+Msb+Lsb,255)
480 ! NEXT I
490 ! Checksum=BINAND(0-Checksum,255)
500 !                                     ! Converts to 2's complement.
510 !
520 ! CLEAR @Scope
530 !                                     ! Aborts pending or incomplete
540 !                                     ! operations.
550 !
560 ! OUTPUT @Scope;"INPUT ST0"&Wfm$
570 !                                     ! Selects the memory receiving Curve
580 !                                     !
590 ! OUTPUT @Scope;"CURVE %";
600 !                                     ! Transmits header and curve data.
610 ! OUTPUT @Scope USING "#,W";Bytecount,Curve(*)
620 ! OUTPUT @Scope USING "B";Checksum
630 ! END

```

6106-382

Figure 3-26. Waveform Transfer to the 1130X—Binary Format.

```

100 !           ASCII Waveform Transfer to 1130X Example
110 !
120 !   This example constructs a waveform array and transmits it to the
130 !   1130X.
140 !   The terminator of the 1130X can be set for "EOI or LF" or "EOI."
150 !
160 !   Variables used:
170 !   Scope.....is the primary device address of the 1130X plus 700.
180 !   Wfm$.....is the target/destination memory(1 or 2) in the 1130X.
190 !   Curve(*)....is an integer array representing the waveform values.
200 !
210 !-----
220 !
230 ASSIGN @Scope TO 701;EOL CHR$(10) END ! Sets end-of-line to use EOI&LF.
240 !
250 Wfm$="2"                               ! Declare and define variables.
260 !                                     1 is for ST01. 2 is for ST02.
270 INTEGER Curve(1023)
280 !
290 DEG                                     ! Generates one cycle sine wave.
300 FOR I=0 TO 1023
310   Curve(I)=SIN(I*360/1024)*256
320 NEXT I
330 !
340 CLEAR @Scope                           ! Aborts pending or incomplete
350 !                                     operations.
360 !
370 OUTPUT @Scope;"INPUT ST0"&Wfm$        ! Selects the memory receiving data.
380 !
390 OUTPUT @Scope;"CURVE ";Curve(*)       ! Transmits header and curve data.
400 END

```

6106-383

Figure 3-27. Waveform Transfer to the 1130X—ASCII Format.

Utility Programs for IBM PC-XT-AT Controllers

These examples are for use with the IBM PC-XT-AT computers configured with an RS-232-C interface. The programs are written in IBM BASICA.

- Front-panel Settings from the 1130X—ASCII Format
- Automatic Measurement Operation—String Format
- Counter Timer Frequency Measurements
- Waveform Transfer to the 1130X—ASCII Format
- Device Clear Operation

```

100      ASCII Setting from 1130X Example
110
120      This program retrieves the current 1130X instrument set-up as an ASCII
130      string and then sends them back. The minimum length of this string will
140      depend upon the configuration of the 1130X and its plug-ins. This program
150      will operate with LONGFORM ON or LONGFORM OFF and at any baud rate.
160      Also, when calling BASIC from MSDOS, be sure to allocate a buffer size
170      of at least 5000. The call should look like this:
180      A> BASICA/C:5000
190
200      Variables used:
210      RESPONSE#.returns the 1130X settings.
220      K.....is the last index into RESPONSE#.
230
240      Subroutines used:
250      lines 800-840....sends the contents of RESPONSE#(I) to the 1130X. The
260      carriage-return which is usually sent with a print
270      statement is suppressed while the string array is
280      sent. After the last string is sent, a carriage-
290      return is sent to signal end-of-line (termination)
300      to the 1130X.
310      lines 1000-1070..reads from the Com buffer and builds the string called
320      RESPONSE# used to return an 1130X query response.
330      The string will continue building until a carriage
340      return is detected as the 1130X end-of-line. DO NOT
350      use line-feed and carriage-return as end-of-line.
360      The string RESPONSE# is dimensioned large enough to
370      accept up to 4080 characters from the 1130X. The
380      variable K is incremented every 255 characters.
390      Therefore there are at least K*255 but no more than
400      (K+1)*255 characters received.
410
420      -----
430
440 DIM RESPONSE$(15)
450 BAUD$="9600"
460 PORT$= "COM1:"+BAUD$+",N,8,1,CS9000"
470 OPEN PORT$ AS #1
480
490 PRINT #1,"RUS OFF"
500
510 PRINT #1,"RS232 ECHO:OFF,EOL:CR,FLAGGING:HARD,DELAY:0,HARDLINE:CTS"
520
530
540
550
560 CLOSE 1
570 OPEN PORT$ AS #1
580
590 PRINT #1,"ENCDG SET:ASCII"
600 PRINT #1,"SET?"
610 GOSUB 1000
620
630 GOSUB 800
640 END
650
660 FOR I=0 TO K
670 PRINT #1,RESPONSE$(I):
680 NEXT I
690 PRINT #1,""
700 RETURN
710
720
730
740
750
760
770
780
790
800
810
820
830
840
850
860
870
880
890
900
910
920
930
940
950
960
970
980
990
1000 ERASE RESPONSE#
1010 DIM RESPONSE$(15)
1020 K=-1
1030 IF LOC(1)<1 THEN 1030
1040 K=K+1
1050 LINE INPUT #1,RESPONSE$(K)
1060 IF LEN(RESPONSE$(K))=255 THEN 1040
1070 RETURN

```

6106-384

Figure 3-28. Front Panel Settings from the 1130X—ASCII Format.

```

100 Automatic Measurement Example
110 (Returns a String)
120
130 The program and subroutines below demonstrate how to specify the desired
140 measurements, initiate them, wait for them to be completed and finally
150 how to retrieve and print the results. This example returns the results
160 as an ASCII string called Meas#. This program will operate at any baud
170 rate.
180 DON'T FORGET to define and select a "Scope" trace prior to execution.
190 Also, when calling BASIC from MSDOS, be sure to allocate a buffer size of
200 at least 5000. The call should look like this:
210 A> BASIC/A/C:5000
220
230 Variables used:
240 MEAS#.....returns the entire measurement result.
250 STBYTE.....returns the Status Byte from the 1130X.
260 EVENT.....returns the Event Code reflecting the 1130X status.
270 RESPONSE#..is a temporary string array used to return query responses.
280 K.....is the last index into RESPONSE#.
290
300 Subroutines used:
310 lines 900-990....when used with the RS232 SRQ:ASCII command, waits for
320 1130X to send its ASCII service request message and
330 queries the 1130X's Status Byte and accompanying
340 Event code. These are returned as STBYTE and EVENT,
350 respectively. This routine also calls lines 1000 to
360 1070. LONGFORM must be set to ON.
370 lines 1000-1070..reads from the Com buffer and builds the string called
380 RESPONSE# used to return an 1130X query response.
390 The string will continue building until a carriage
400 return is detected as the 1130X end-of-line. DO NOT
410 use line-feed and carriage-return as end-of-line.
420 The string RESPONSE# is dimensioned large enough to
430 accept up to 4080 characters from the 1130X. The
440 variable K is incremented every 255 characters.
450 Therefore, there are at least K*255 but no more than
460 (K+1)*255 characters received.
470
-----
480
490
500 DIM RESPONSE$(15)
510 BAUD#="9600"
520 PORT#="COM1:"+BAUD#+".N.8.1"
530 OPEN PORT# AS #1
540
550 PRINT #1,"ROS OFF;CTMEAS OFF"
560
570 PRINT #1,"LONGFORM ON"
580
590 PRINT #1,"RS232 ECHO:OFF,EDL:CR,FLAGGING:HARD,DELAY:0,SRQ:ASC,HARDLINE:CTS"
600
610
620
630
640 PRINT #1,"MSLIST FREQ,PER,WID,DUTY,PF,MAX,MIDD,MINI"
650
660
670
680
690 CLOSE #1 : OPEN PORT# AS #1
700
710 PRINT #1,"ALLEV?"
720 GOSUB 1000
730
740 PRINT #1,"SRUMASK OFC:UN;ROS ON"
750 PRINT #1,"AUTOMEASURE START"
760
770 STRYTE=0
780 EVENT=0
790 GOSUB 900
800 IF STRYTE<>2 OR EVENT<>463 THEN 790
810
820
830 PRINT #1,"MEAS?"
840 GOSUB 1000
850 MEAS#=RESPONSE$(0)
860 PRINT MEAS#
870 END
880
890 IF LOC(1)<#1 THEN 900
910 CLOSE #1 : OPEN PORT# AS #1
920 PRINT #1,"ROS OFF;STRYTE?;EVENT?"
930 GOSUB 1000
940 F=INSTR(RESPONSE$(0),"STRYTE")
950 STRYTE=VAL(MID$(RESPONSE$(0),F+7,3))
960 F=INSTR(RESPONSE$(0),"EVENT")
970 EVENT=VAL(MID$(RESPONSE$(0),F+6,3))
980 PRINT #1,"ROS ON"
990 RETURN
1000
1000 ERASE RESPONSE#
1010 DIM RESPONSE$(15)
1020 K=-1
1030 IF LOC(1)<#1 THEN 1050
1040 K=K+1
1050 LINE INPUT #1,RESPONSE$(K)
1060 IF LEN(RESPONSE$(K))=255 THEN 1040
1070 RETURN

```

6106-385

Figure 3-29. Automatic Measurement Operation—String Format.

```

100      Counter Timer Frequency Measurement Example
110      (Returns a string)
120
130      The program and subroutines below demonstrate how to set up the Counter
140      Timer for a measurement, initiate it, wait for it to be completed, and
150      finally how to retrieve and print the results. This example returns the
160      results as a string variable called RESULT#. This program will operate
170      at any baud rate.
180      Also, when calling BASIC from MSDOS, be sure to allocate a buffer size
190      of at least 5000. The call should look like this:
200      A: BASICA/C:5000
210
220      Variables used:
230      RESULT#....returns the frequency result.
240      STBYTE#....returns the Status Byte of the 1130X.
250      EVENT#....returns the Event Code reflecting the 1130X status.
260      RESPONSE#..is a temporary string array used to return query responses.
270      K.....is the last index into RESPONSE#.
280
290      Subroutines used:
300      lines 900-990....when used with the RS232 SRD:ASCII command, waits for
310      1130X to send its ASCII service request message and
320      queries the 1130X's Status Byte and accompanying
330      Event code. These are returned as STBYTE and EVENT,
340      respectively. This routine also calls lines 1000 to
350      1070. LONGFORM must be set to ON.
360      lines 1000-1070...reads from the Com buffer and builds the string called
370      RESPONSE# used to return an 1130X query response.
380      The string will continue building until a carriage
390      return is detected as the 1130X end-of-line. DO NOT
400      use line-feed and carriage-return as end-of-line.
410      The string RESPONSE# is dimensioned large enough to
420      accept up to 4089 characters from the 1130X. The
430      variable k is incremented every 255 characters.
440      Therefore, there are at least k*255 but no more than
450      (k+1)*255 characters received.
460
470      -----
480
490 DIM RESPONSE$(15)
500 BAUD#= "9600"
510 PORT#= "COM1:"+BAUD#+",N,8,1"
520 OPEN PORT# AS #1
530
540 PRINT #1,"RDS OFF"
550 PRINT #1,"LONGFORM ON"
560
570 PRINT #1,"RS232 ECHO:OFF,EOL:CR,FLAGGING:HARD,DELAY:0,SRD:ASC,HARDLINE:CTS"
580
590
600
610 PRINT #1,"CTMEAS OFF"
620 PRINT #1,"CTFREQ AVER:0,GATING:OFF,UPDATE:MAN,SOURCE:MAINTRIG,REF:0"
630
640
650      This specifies the set up for the
660      frequency measurement. MANUAL UPDATE
670      is used as it will produce only one
680      event when the measurement is done.
690
690 CLOSE #1 : OPEN PORT# AS #1
700
710 PRINT #1,"ALLEV?"
720 GOSUB 1000
730
740 PRINT #1,"SRDMASK UPC:ON:RDS ON"
750 PRINT #1,"CTMEAS FREQ"
760
770 STBYTE=0
780 EVENT=0
790 GOSUB 900
800 IF STBYTE=2 OR EVENT=4&B THEN 790
810
820 PRINT #1,"RDS OFF:RESULT?"
830 GOSUB 1000
840 RESULT#=RESPONSE$(0)
850 PRINT RESULT#
860 END
870
890 IF LOC(1)=1 THEN 990
910 CLOSE 1 : OPEN PORT# AS #1
920 PRINT #1,"RDS OFF:STBYTE:EVENT?"
930 GOSUB 1000
940 P=INSTR(RESPONSE$(0),"STBYTE")
950 STBYTE=VAL(MID$(RESPONSE$(0),P+7,3))
960 P=INSTR(RESPONSE$(0),"EVENT")
970 EVENT=VAL(MID$(RESPONSE$(0),P+6,3))
980 PRINT #1,"RDS ON"
990 RETURN
995
1000 ERASE RESPONSE#
1010 DIM RESPONSE$(15)
1020 k=-1
1030 IF LOC(1)<1 THEN 1050
1040 k=k+1
1050 LINE INPUT #1,RESPONSE$(k)
1060 IF LEN(RESPONSE$(k))=255 THEN 1040
1070 RETURN

```

6106-386

Figure 3-30. Counter Timer Frequency Measurements.

```

100 '          ASCII Waveform Transfer to 1130X Example
110 '
120 ' This example constructs a waveform array and transmits it to the 1130X.
130 ' The waveform is sent in ASCII format to the desired Reference Waveform
140 ' memory (1 or 2). This program will operate with LONGFORM ON or LONGFORM
150 ' OFF and at any baud rate.
160 ' Also, when calling BASIC from MSDOS, be sure to allocate a buffer size
170 ' of at least 5000. The call should look like this:
180 '          A> BASICA/C:5000
190 '
200 ' Variables used:
210 '   WFM#.....is the target/destination memory (1 or 2) in the 1130X.
220 '   CURVE#(*)..is an integer array representing the waveform values.
230 '
240 '-----
250 '
260 DIM CURVE%(1023) ' Declare and define variables.
270 WFM#="1" ' 1 is for ST01. 2 is for ST02.
280 BAUD#="9600" ' System Baud rate.
290 PORT#="COM1:"+BAUD#+".N.8.1.CS9000" ' Defines the Asvnc port characteristics
300 OPEN PORT# AS #1 ' Declares COM1 as file #1.
310 '
320 PRINT #1,"RQS OFF" ' Disables 1130X service requests.
330 '
340 PRINT #1,"RS232 ECHO:OFF,EOL:CR,FLAGGING:HARD,DELAY:0,HARDLINE:CTS"
350 '
360 ' Sets the 1130X end-of-line to a
370 ' carriage return and HARD handshaking.
380 '
390 FOR I=0 TO 1023 ' Generates a one cycle sine wave.
400 CURVE%(I)=SIN((2*3.1415/1024)*I)*256
410 NEXT I
420 '
430 PRINT #1,"INPUT ST0"+WFM# ' Selects the memory receiving data.
440 '
450 PRINT #1,"CURVE "; ' Transmits the header and curve data.
460 FOR I=0 TO 1023
470 PRINT #1,USING " ,####":CURVE%(I); ' Sends the data while suppressing
480 NEXT I ' carriage-returns.
490 PRINT #1,"" ' Sends a carriage-return as the EOL.
500 END

```

6106-387

Figure 3-31. Waveform Transfer to the 1130X—ASCII Format.

```

100 '          Device Clear (Break Sender)
110 '
120 ' This routine will generate a BREAK which can be used to perform a
130 ' Device Clear on the 1130X. This is useful in aborting data transfer
140 ' operations which cannot be terminated through the use of End-of-Line(EOL)
150 ' characters. For example, binary data transfers will regard the EOL
160 ' character(s) as ordinary data until a byte count is satisfied. Also,
170 ' quoted strings as used with the TEXT command require termination with a
180 ' quote character. All others are interpreted as part of the string.
190 ' Sending a BREAK will bail you out of nearly any mess you can get into.
200 '
210 '-----
220 '
2000 C%=INP(&H3FB) ' This generates a BREAK.
2010 Z%=C% OR &H40
2020 OUT &H3FB,Z%
2030 FOR I=1 TO 500 : NEXT I
2040 OUT &H3FB,C%
2050 RETURN

```

6106-388

Figure 3-32. Device Clear Operation.

Section 4 Specification

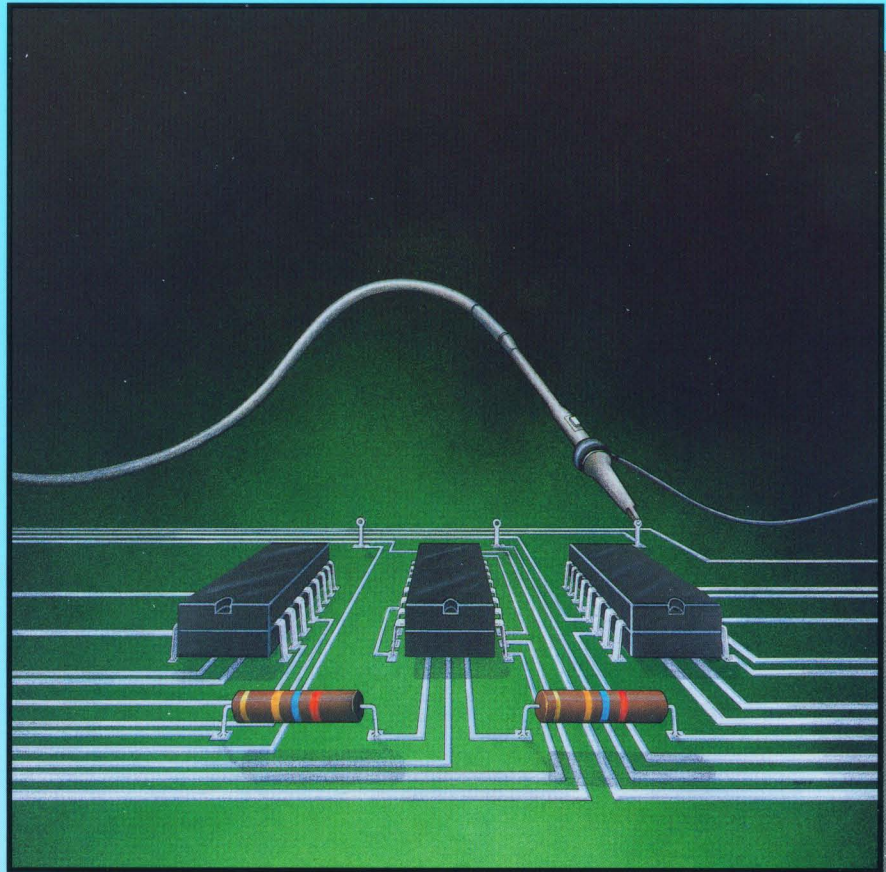

Contents

Electrical Characteristics.....	4-1
11301 Cathode-Ray Tube.....	4-1
11302 Cathode-Ray Tube with Micro Channel Plate (MCP).....	4-1
Ac Power Source.....	4-2
Battery Backup Memory.....	4-2
Counter/Timer.....	4-3
External Connectors.....	4-15
Horizontal Deflection System.....	4-22
Holdoff.....	4-27
Triggering, Main and Dly'd.....	4-30
Vertical Deflection System.....	4-33
Environmental Characteristics.....	4-35
Physical Characteristics.....	4-37
Dimensional Drawings.....	4-38
System Specification.....	4-40
Vertical Bandwidth.....	4-40
Dc Vertical Accuracy Using Cursors.....	4-41
Horizontal Deflection Accuracy (XY) of Center Plug-in.....	4-42
Measurement Accuracy.....	4-43
Trigger Level Readout Accuracy.....	4-43

Specification

The specifications that follow apply when:

- The instrument has been calibrated at an ambient temperature between +18°C and +23°C by a qualified service technician.
- All plug-in compartments are full. Unused compartments can be filled with blank units (Tektronix Part No. 016-0829-00).
- The instrument has reached thermal equilibrium, which requires a 20-minute warm-up period.
- The instrument is in the Enhanced Accuracy condition. Enhanced Accuracy is indicated on the CRT display and remains in effect as long as the internal mainframe temperature does not change 5°C or more from the temperature at which the Enhanced Accuracy condition was entered.

If the internal mainframe temperature changes 5°C or more, the accuracy condition of the instrument becomes Not Enhanced.

When operating in the Not Enhanced Accuracy condition or with one or more empty plug-in compartments, those Characteristics that are temperature sensitive may not remain within the limits of these specifications.

Electrical Characteristics

TABLE 4-1
Electrical Specification

Characteristics	Performance Requirements
11301 Cathode-Ray Tube	
Display	8 x 10 divisions; 1.22 cm/div.
Graticule	8 x 10 divisions with 5 divisions rise-time markings (0%, 10%, 90%, and 100%).
Phosphor	Standard P31.
Acceleration Voltage	22 kV.

TABLE 4-1 (cont)
Electrical Specification

Characteristics	Performance Requirements
11302 Cathode-Ray Tube with Micro Channel Plate (MCP)	
Display	8 x 10 divisions; 1.00 cm/div.
Graticule	8 x 10 divisions with 5 divisions rise-time graticule markings (0%, 10%, 90%, and 100%).
Phosphor	Standard P31.
Visual Writing Speed	≥6 cm/ns at 20 fc (footcandle ambient illumination).
Ac Power Source	
Source Voltage	
Nominal Ranges	
115 V	90 V to 132 V.
230 V	180 V to 250 V.
Source Frequency	48 Hz to 440 Hz.
Fuse Rating	6 A, 250 V, Normal blow.
Power Consumption	
Maximum	240 watts. Fully optioned instrument including plug-ins.
Maximum Line Current	3.6 A rms at 50 Hz, 90 V with 5% clipping of voltage peak.
Primary Circuit Dielectric Voltage Withstand Test	1500 V rms, 60 Hz for 10 seconds without breakdown.
Primary Grounding	Routine test to check grounding continuity between chassis ground and protective earth ground.

Specification

The specifications that follow apply when the instrument is in the condition of Enhanced Accuracy. Enhanced Accuracy is obtained by performing an Enhanced Calibration in the specific host mainframe after the system has reached thermal equilibrium, which requires 20 minutes warmup. Enhanced Accuracy is indicated on the crt display and remains in effect as long as the mainframe internal temperature change is less than 5° C from the temperature at which the calibration was performed. When the 5° C change does occur the accuracy condition becomes Not-Enhanced. In the Not-Enhanced condition those Characteristics that are temperature sensitive may not remain within the limits of these specifications.

Electrical Characteristics

TABLE 4-1
Electrical Specification

Characteristics	Performance Requirements
11301 Cathode-Ray Tube	
Display	8 x 10 divisions; 1.22 cm/div.
Graticule	8 x 10 divisions with 5 divisions rise-time markings (0%, 10%, 90%, and 100%).
Phosphor	Standard P31.
Acceleration Voltage	22 kV.
11302 Cathode-Ray Tube with Micro Channel Plate (MCP)	
Display	8 x 10 divisions; 1.00 cm/div.
Graticule	8 x 10 divisions with 5 divisions rise-time graticule markings (0%, 10%, 90%, and 100%).
Phosphor	Standard P31.
Visual Writing Speed	≥6 cm/ns at 20 fc (footcandle ambient illumination).

TABLE 4-1 (cont)
Electrical Specification

Characteristics	Performance Requirements
Ac Power Source	
Source Voltage	
Nominal Ranges	
115 V	90 V to 132 V.
230 V	180 V to 250 V.
Source Frequency	48 Hz to 440 Hz.
Fuse Rating	6 A, 250 V, Normal blow.
Power Consumption	
Maximum	240 watts. Fully optioned instrument including plug-ins.
Maximum Line Current	3.6 A rms at 50 Hz, 90 V with 5% clipping of voltage peak.
Primary Circuit Dielectric Voltage Withstand Test	1500 V rms, 60 Hz for 10 seconds without breakdown.
Primary Grounding	Routine test to check grounding continuity between chassis ground and protective earth ground.
Battery Backup Memory	
Battery Backup Memory	
Backup Time	5 years.
Cell Type	Lithium.
Character Display	
Number of Characters per line	50 per line. 10 per div in top and bottom divs, 5 per div in center 6 divisions.
Number of lines	16 lines. 2 per division.

Table 4-1 (cont)
Electrical Specification

Characteristic	Performance Requirement
Battery Backup Memory	
Battery Backup Memory	
Backup Time	5 years.
Cell Type	Lithium.
Character Display	
Number of Characters per line	50 per line. 10 per div in top and bottom divs, 5 per div in center 6 divisions.
Number of lines	16 lines. 2 per division.
Counter/Timer	
General	
Display	
Auto Update	With Auto Update selected, N is greater of one period or the number of periods that occur in a 300 ms interval.
Averaging	Resolution may be improved by averaging. The number of measurements made will be sufficient to guarantee the higher resolution and may be greater than the minimum number of measurements necessary to attain the displayed resolution. The amount of averaging is selectable in two decade steps (1, $\approx 10^2$, $\approx 10^4$, etc.) up to $\approx 10^{10}$ for Frequency, Period, Width, Ratio, and A→B measurements except for Total, which may not be averaged.
Display Update Rate	Auto updating occurs at the maximum rate of three times per second. Manual updating occurs upon pressing the Trigger RESET button, selecting another measurement, or a low to high transition of the rear-panel TRIGGER RESET INPUT.

TABLE 4-1 (cont)
Electrical Specification

Characteristics	Performance Requirements
Counter/Timer (cont)	
General (cont)	
Number of Digits	Up to 7 digits (10 digits using the external reference or optional high-stability reference) may be displayed. Engineering notation is used for positioning of the decimal point except for totaling events measurements.
Gating	
Minimum Arm/Disarm Time Between CT External A & B Inputs	25 ns.
Minimum CT External B Width	25 ns.
Sensitivity	
Main & Dly'd Triggers CT External A & B Inputs	2 x Sweep Trigger Sensitivity. 3 times the Sweep Trigger Sensitivity for Frequency >50 MHz, Averages $\geq 10^8$ for FREQ, PERIOD, RATIO, and TOTALIZE. See External Connector Section.
Measurement Functions	
Frequency	
Internal Main and Dly'd Triggers and CT External A Source	
Range	1 mHz to 500 MHz.
Least Significant Digit (LSD)	$10 \exp \{ \text{Int}(\log((1.8\text{ns})F^2 / (N \pm F(1.8 \text{ ns}))) + 1) \}$.
Ungated Resolution (in Hz)	Greater of $\text{LSD} \pm 1.4(TJE)F^2/N$ or 1 count.
Gated Resolution	$\pm 1.8 \text{ ns} (F^2)/n$ $\pm 1.4(TJE)F^2/n$
Accuracy (in Hz)	Resolution $\pm F(TBE)$.

Table 4-1 (cont)
Electrical Specification

Characteristic	Performance Requirement
Counter/Timer	
General	
Display	
Auto Update	With Auto Update selected, N is greater of one period or the number of periods that occur in a 300 ms interval.
Averaging	Resolution may be improved by averaging. The number of measurements made will be sufficient to guarantee the higher resolution and may be greater than the minimum number of measurements necessary to attain the displayed resolution. The amount of averaging is selectable in two decade steps (1, $\approx 10^2$, $\approx 10^4$, etc.) up to $\approx 10^{10}$ for Frequency, Period, Width, Ratio, and A→B measurements except for Total, which may not be averaged.
Display Update Rate	Auto updating occurs at the maximum rate of three times per second. Manual updating occurs upon pressing the Trigger RESET button, selecting another measurement, or a low to high transition of the rear-panel TRIGGER RESET INPUT.
Number of Digits	Up to 7 digits (10 digits using the external reference or optional high-stability reference) may be displayed. Engineering notation is used for positioning of the decimal point except for totaling events measurements.

TABLE 4-1 (cont)
Electrical Specification

Characteristics	Performance Requirements
Counter/Timer (cont)	
General (cont)	
Gating	
Minimum Arm/Disarm Time Between CT External A & B Inputs	25 ns.
Minimum CT External B Width	25 ns.
Sensitivity	
Main & Dly'd Triggers CT External A & B Inputs	2 x Sweep Trigger Sensitivity. 3 times the Sweep Trigger Sensitivity for Frequency >50 MHz, Averages $\geq 10^8$ for FREQ, PERIOD, RATIO, and TOTALIZE. See External Connector Section.
Measurement Functions	
Frequency	
Internal Main and Dly'd Triggers and CT External A Source	
Range	1 mHz to 500 MHz.
Least Significant Digit (LSD)	$10 \exp \{ \text{Int}(\log((1.8\text{ns})F^2 / (N \pm F(1.8 \text{ ns}))) + 1) \}$.
Ungated Resolution (in Hz)	Greater of $\text{LSD} \pm 1.4(TJE)F^2/N$ or 1 count.
Gated Resolution	$\pm 1.8 \text{ ns } (F^2)/n$ $\pm 1.4(TJE)F^2/n$
Accuracy (in Hz)	Resolution $\pm F(TBE)$.

Table 4-1 (cont)
Electrical Specification

Characteristic	Performance Requirement
Counter/Timer (cont)	
Measurement Functions (cont)	
Period	
Internal Main and Dly'd Trigger Sources	
Range	2 ns to 1000 s.
Least Significant Digit (LSD)	1.8 ns/N.
Ungated resolution (in s)	$LSD \pm 1.4(TJE)/N.$
Gated Resolution	$2 \text{ ns}/n \pm 1.4(TJE)/n.$
Accuracy (in Hz)	Resolution $\pm TBE(P).$
CT External A Source	
Range	2 ns to 1000 s.
Least Significant Digit (LSD)	1.8 ns/N.
Ungated Resolution	$LSD \pm 1.4(TJE)/N.$
Gated Resolution	$2 \text{ ns}/n \pm 1.4(TJE)/n.$
Accuracy (in Hz)	Resolution $\pm TBE(P).$

TABLE 4-1 (cont)
Electrical Specification

Characteristics	Performance Requirements
Counter/Timer (cont)	
Measurement Functions (cont)	
Ratio	
Internal Main and Dly'd Trigger Sources	
Range	10 ⁻¹¹ to 10 ¹¹ .
Frequency Range	1 MHz to 400 MHz.
Least Significant Digit (LSD)	Ratio/10 ¹⁰ .
Ungated Resolution	LSD ±1.4(TJE _D /N _D) ± 1.4(TJE _M /N _M) ± F _M ² /(F _D ² ± F _M F _D) where N refers to Main trigger events.
Accuracy	Same as resolution.
CT External A and B Sources	
Range	10 ⁻¹¹ to 10 ¹¹ .
Frequency Range	1 MHz to 400 MHz.
Least Significant Digit (LSD)	Ratio/10 ¹⁰ .
Ungated Resolution	LSD ±1.4(TJE _B /N _B) ± 1.4(TJE _A /N _A) ± F _A ² /(F _B ² ± F _A F _B) where N refers to CT External A events.
Accuracy	Same as resolution.

Table 4-1 (cont)
Electrical Specification

Characteristic	Performance Requirement
Counter/Timer (cont)	
Measurement Functions (cont)	
Total	
Internal Main and Dly'd Triggers and CT External A & B Sources	
Range	0 to 10^{15} counts (engineering notation used above $10^{11}-1$ with 10 digit resolution).
Repetition Rate	>0 Hz to 500 MHz.
Least Significant Digit (LSD), Resolution and Accuracy	1 up to $10^{11}-1$.
Elapsed Time Range	25 ns to 1250 hrs.
Width	
Internal Main and Dly'd Triggers and CT External A & B Sources	
Range	2 ns to 1000 s.
Maximum Repetition Rate	200 MHz (100 MHz for CT Ext A & B sources).
Least Significant Digit (LSD)	2ns (for N=1); $10\text{ns}/\sqrt{N}$ (for N>1).
Resolution	$\text{LSD} \pm 1.4((TJ_{E_L}) \pm 1.4(TJ_{E_T}))/\sqrt{N} \pm 2 \text{ ps.}$ (For $1 \leq N \leq 10^6$).
Accuracy (gated and nongated)	Resolution $\pm \text{Width}(TBE)$ $\pm \text{Hysteresis error}$ $\pm TLE / (\text{Slew}_E - \text{Slew}_S) \pm 1\text{ns.}$ NOTE <i>Slew rate may be limited by the plug-in amplifier used as the signal source.</i>

TABLE 4-1 (cont)
Electrical Specification

Characteristics	Performance Requirements
Counter/Timer (cont)	
Measurement Functions (cont)	
Time Interval	
Main to Dly'd Sweep (only one Dly'd Window)	
Delay Time	
Runs After	
Range	0 to 10 times the Main Time/div setting.
Least Significant Digit (LSD)	2 ns (for N=1); 10 ns /√N (for N>1).
Resolution	±LSD ±(DJ/√N) ±1.4TJEM/√N (for 1 ≤ 10 ⁶). ±3 × 10 ⁻⁴ (Main Time/div).
Accuracy	±Resolution ±TBE (Result) ± 50 ns.
Triggered After	
Range	
Range	75 ns to 10 times the Main Time/div setting.
Least Significant Digit (LSD)	2 ns (for N=1); 10 ns/√N (for N>1).
Resolution	±LSD ± 1.4 TJEM/√N ±1.4 TJED/√N (for 1≤N≤10 ⁶).
Accuracy	
15°C to 35°C	±TLEM/SlewM ± TLED/SlewD ±Resolution ±TBE(Result)±500 ps.
0°C ≤T<15°C or 35°C<T≤50°C	Add ±700 ps to 15°C to 35°C tolerance.

Table 4-1 (cont)
Electrical Specification

Characteristic	Performance Requirement
Counter/Timer (cont)	
Measurement Functions (cont)	
Total	
Internal Main and Dly'd Triggers and CT External A & B Sources	
Range	0 to 10^{15} counts (engineering notation used above $10^{11}-1$ with 10 digit resolution).
Repetition Rate	>0 Hz to 500 MHz.
Least Significant Digit (LSD), Resolution and Accuracy	1 up to $10^{11}-1$.
Elapsed Time Range	25 ns to 1250 hrs.
Width	
Internal Main and Dly'd Triggers and CT External A & B Sources	
Range	2 ns to 1000 s.
Maximum Repetition Rate	200 MHz (100 MHz for CT Ext A & B sources).
Least Significant Digit (LSD)	2ns (for N=1); 10ns/ \sqrt{N} (for N>1).
Resolution	LSD $\pm 1.4((TJE_L) \pm 1.4(TJE_T))/\sqrt{N} \pm 2$ ps. (For $1 \leq N \leq 10^6$).
Accuracy (gated and nongated)	Resolution \pm Width(TBE) \pm Hysteresis error $\pm TLE / (\text{Slew}_E - \text{Slew}_S) \pm 1$ ns. NOTE <i>Slew rate may be limited by the plug-in amplifier used as the signal source.</i>

TABLE 4-1 (cont)
Electrical Specification

Characteristics	Performance Requirements
Counter/Timer (cont)	
Measurement Functions (cont)	
Time Interval	
Main to Dly'd Sweep (only one Dly'd Window)	
Delay Time	
Runs After	
Range	0 to 10 times the Main Time/div setting.
Least Significant Digit (LSD)	2 ns (for N=1); 10 ns / \sqrt{N} (for N>1).
Resolution	$\pm\text{LSD} + (\text{DJ}/\sqrt{N})$ $\pm 1.4\text{TJEM}/\sqrt{N}$ (for $1 \leq 10^6$). $\pm 3 \times 10^{-4}$ (Main Time/div).
Accuracy	$\pm\text{Resolution}$ $\pm\text{TBE (Result)} + 50 \text{ ns}$.
Triggered After	
Range	75 ns to 10 times the Main Time/div setting.
Least Significant Digit (LSD)	2 ns (for N=1); 10 ns / \sqrt{N} (for N>1).
Resolution	$\pm\text{LSD} + 1.4 \text{TJEM}/\sqrt{N}$ $\pm 1.4 \text{TJED}/\sqrt{N}$ (for $1 \leq N \leq 10^6$).
Accuracy	$\pm\text{TLEM}/\text{SlewM} + \text{TLED}/\text{SlewD}$ $\pm\text{Resolution}$ $\pm\text{TBE(Result)} \pm 500 \text{ ps}$.

Table 4-1 (cont)
Electrical Specification

Characteristic	Performance Requirement
Counter/Timer (cont)	
Measurement Functions (cont)	
Time Interval (cont)	
Delta Delay Time (both Dly'd Windows)	
Runs After	
Range	0 to ± 10 times the Main Time/div setting.
Least Significant Digit (LSD)	2 ns (for $N=1$); 10 ns/ \sqrt{N} (for $N>1$).
Resolution	$\pm \text{LSD} \pm 1.4 \text{ DJ} / \sqrt{N}$ $\pm 2(\text{TJE}_M) / \sqrt{N}$ (for $1 \leq N \leq 10^6$). $\pm 3 \times 10^{-4}$ (Main Time/div).
Accuracy	$\pm \text{Resolution}$ $\pm \text{TBE}(\text{Result})$ $\pm 500 \text{ ps}$
Triggered After	
Range	0 to $\pm(10$ times the Main Time/div setting $-75 \text{ ns})$.
Least Significant Digit (LSD)	2 ns (for $N=1$); 10 ns/ \sqrt{N} (for $N>1$).
Resolution	$\pm \text{LSD} \pm 2 \text{ TJE}_M / \sqrt{N}$ $\pm 1.4 \text{ TJE}_{D1} / \sqrt{N}$ $\pm 1.4 \text{ TJE}_{D2} / \sqrt{N}$ (for $1 \leq N \leq 10^6$).
Accuracy	\pm Channel-to-channel mismatch (plug-in dependent) if different channels are used $\pm \text{Resolution}$ $+ \text{TLE}_{D2} / \text{Slew} - \text{TLE}_{D1} / \text{Slew}$ $\pm \text{TBE}(\text{Result}) \pm 200 \text{ ps}$.

TABLE 4-1 (cont)
Electrical Specification

Characteristics	Performance Requirements
Counter/Timer (cont)	
Measurement Functions (cont)	
Time Interval (cont)	
Main & Delay Trigger Sources	
Range	2 ns to 1250 hrs.
Least Significant Digit (LSD)	2 ns (for N=1); 10 ns/ \sqrt{N} (for N>1).
Resolution	$\pm\text{LSD} \pm (1.4(\text{TJE}_A + \text{TJE}_B)) / \sqrt{N} + 2 \text{ ps}$.
Accuracy	$\pm(\text{TBE})(\text{Time Interval}) \pm \text{Resolution}$ $\pm\text{Plug-In Delay Mismatch}$ $+ \text{TLE}_M / \text{Slew}$ $- \text{TLE}_D / \text{Slew}$ $\pm \text{M to D Offset } 200 \text{ ps}$
Max Rep Rate	200 MHz.
M to D Offset	Nominally 400 ps provided (without null).
CT External A to B Sources	
Range	2 ns to 1250 hrs.
Least Significant Digit (LSD)	2 ns (for N=1); 10 ns/ \sqrt{N} (for N>1).
Resolution	$\pm\text{LSD}$ (for N=1); $\pm(1.4(\text{TJE}_A + \text{TJE}_B)) / \sqrt{N} \pm 2 \text{ ps}$ (for N>1).
Accuracy	$\pm(\text{TBE})(\text{Time Interval}) \pm \text{Resolution}$ $\pm\text{Channel Delay Mismatch}$ $+ \text{EBLE} / \text{Slew}$ $- \text{EALE} / \text{Slew}$ $\pm 500 \text{ ps}$.
Max Rep Rate	200 MHz.
Channel Delay	Not more than $\pm 500 \text{ ps}$ (without null).

Table 4-1 (cont)
Electrical Specification

Characteristic	Performance Requirement
Counter/Timer (cont)	
Measurement Functions (cont)	
Time Interval (cont)	
Delta Delay Time (both Dly'd Windows)	
Runs After	
Range	0 to ± 10 times the Main Time/div setting.
Least Significant Digit (LSD)	2 ns (for N=1); 10 ns/ \sqrt{N} (for N>1).
Resolution	$\pm \text{LSD} + 1.4 \text{ DJ}/\sqrt{N}$ $\pm 2(\text{TJE}_M)/\sqrt{N}$ (for $1 \leq N \leq 10^6$). $\pm 3 \times 10^{-4}$ (Main Time/div).
Accuracy	$\pm \text{Resolution}$ $\pm \text{TBE}(\text{Result})$ $\pm 500 \text{ ps}$
Triggered After	
Range	0 to $\pm(10$ times the Main Time/div setting $-75 \text{ ns})$.
Least Significant Digit (LSD)	2 ns (for N=1); 10 ns/ \sqrt{N} (for N>1).
Resolution	$\pm \text{LSD} + 2 \text{ TJE}_M/\sqrt{N}$ $\pm 1.4 \text{ TJE}_{D1}/\sqrt{N}$ $\pm 1.4 \text{ TJE}_{D2}/\sqrt{N}$ (for $1 \leq N \leq 10^6$).
Accuracy	$\pm \text{Channel-to-channel mismatch}$ (plug-in dependent) if different channels are used $\pm \text{Resolution}$ $+ \text{TLE}_{D2}/\text{Slew} - \text{TLE}_{D1}/\text{Slew}$ $\pm \text{TBE}(\text{Result}) \pm 200 \text{ ps}$.

TABLE 4-1 (cont)
Electrical Specification

Characteristics	Performance Requirements
Counter/Timer (cont)	
Measurement Functions (cont)	
Time Interval (cont)	
Main & Delay Trigger Sources	
Range	2 ns to 1250 hrs.
Least Significant Digit (LSD)	2 ns (for N=1); 10 ns/ \sqrt{N} (for N>1).
Resolution	$\pm\text{LSD} \pm (1.4(\text{TJE}_A + \text{TJE}_B)) / \sqrt{N} + 2 \text{ ps}$.
Accuracy	$\pm(\text{TBE})(\text{Time Interval}) \pm \text{Resolution}$ $\pm\text{Plug-In Delay Mismatch}$ $+\text{TLE}_M/\text{Slew}$ $-\text{TLE}_D/\text{Slew}$ $\pm\text{M to D Offset } 200 \text{ ps}$
Max Rep Rate	200 MHz.
M to D Offset	Nominally 400 ps provided (without null).
CT External A to B Sources	
Range	2 ns to 1250 hrs.
Least Significant Digit (LSD)	2 ns (for N=1); 10 ns/ \sqrt{N} (for N>1).
Resolution	$\pm\text{LSD}$ (for N=1); $\pm(1.4(\text{TJE}_A + \text{TJE}_B)) / \sqrt{N} \pm 2 \text{ ps}$ (for N>1).
Accuracy	$\pm(\text{TBE})(\text{Time Interval}) \pm \text{Resolution}$ $\pm\text{Channel Delay Mismatch}$ $+\text{EBLE}/\text{Slew}$ $-\text{EALE}/\text{Slew}$ $\pm 500 \text{ ps}$.
Max Rep Rate	200 MHz.
Channel Delay Mismatch	Not more than $\pm 500 \text{ ps}$ (without null).

Table 4-1 (cont)
Electrical Specification

Characteristic	Performance Requirement
Counter/Timer (cont)	
Mismatch	
Time Base	
Standard Internal Time Base	
Frequency	10 MHz, ± 50 Hz
Temperature Stability	± 50 Hz, $5 (10^{-6})$ 0 to 50° C (5 ppm).
Aging	<10 Hz/year (1 ppm/yr).
Adjustment Resolution	0.5 Hz.
Optional Internal Time Base (Option 1T)	
Frequency	10 MHz, (at calibration), ± 0.2 Hz (0.02 ppm).
Temperature Stability	± 2 Hz 0 to 50° C (0.2 ppm).
Warm-up time	10 minutes at 25° C to within 0.4 ppm of final frequency. 24 hours at 25° C to within 0.2 ppm of final frequency.
Aging	$1(10^{-8})$ per day at time of shipping. $4 (10^{-8})$ per week after 30 days continuous operation. $<1(10^{-6})$ per/year after 60 days continuous operation.
Short Term Stability	$\leq 1(10^{-9})$ rms based on 60 consecutive 1 second measurements.
Adjustment Resolution	0.2 Hz.
Adjustment Range	Sufficient for 8 years of aging.

TABLE 4-1 (cont)
Electrical Specification

Characteristics	Performance Requirements
Counter/Timer (cont)	
Counter-View	
Amplitude	1 div p-p within 20%. (10 MHz).
Rise Time	2 ns or less.
Aberrations	25% p-p.
Sources	Dly'd Gate Synchronized Gate Counter Input A External Input B External Input

Definitions of Terms for the Counter/Timer

DJ = Delay Jitter.

EALE = CT External A Input Level Error.

EBLE = CT External B Input Level Error.

en1 = input signal rms noise voltage.

en2 = rms noise voltage contributed by the plug-in.

en3 = rms noise voltage contributed by the mainframe trigger (see trigger and external input specs).

F = frequency of the signal being measured. (F=1/P)

F_A = F of the CT External A Trigger Source.

F_B = F of the CT EXternal B Trigger Source.

F_D = F of the Dly'd Trigger Source.

F_M = F of the Main trigger source.

Table 4-1 (cont)
Electrical Specification

Characteristic	Performance Requirement
Counter/Timer (cont)	
Time Base	
Standard Internal Time Base	
Frequency	10 MHz, ± 50 Hz
Temperature Stability	± 50 Hz, $5 (10^{-6})$ 0 to 50° C (5 ppm).
Aging	<10 Hz/year (1 ppm/yr).
Adjustment Resolution	0.5 Hz.
Optional Internal Time Base (Option 1T)	
Frequency	10 MHz, (at calibration), ± 0.2 Hz (0.02 ppm).
Temperature Stability	± 2 Hz 0 to 50° C (0.2 ppm).
Warm-up time	10 minutes at 25° C to within 0.2 ppm of final frequency.
Aging	1(10^{-8}) per day at time of shipping. 4 (10^{-8}) per week after 30 days continuous operation. <1(10^{-6}) per/year after 60 days continuous operation.
Short Term Stability	$\leq 1(10^{-9})$ rms based on 60 consecutive 1 second measurements.
Adjustment Resolution	0.2 Hz.
Adjustment Range	Sufficient for 8 years of aging.

TABLE 4-1 (cont)
Electrical Specification

Characteristics	Performance Requirements
Counter/Timer (cont)	
Counter-View	
Amplitude	1 div p-p within 20%. (10 MHz).
Rise Time	2 ns or less.
Aberrations	25% p-p.
Sources	Dly'd Gate Synchronized Gate Counter Input A External Input B External Input

Definitions of Terms for the Counter/Timer

DJ = Delay Jitter.

EALE = CT External A Input Level Error.

EBLE = CT External B Input Level Error.

en1 = input signal rms noise voltage.

en2 = rms noise voltage contributed by the plug-in.

en3 = rms noise voltage contributed by the mainframe trigger (see trigger and external input specs).

F = frequency of the signal being measured. (F=1/P)

F_A = F of the CT External A Trigger Source.

F_B = F of the CT EXternal B Trigger Source.

F_D = F of the Dly'd Trigger Source.

F_M = F of the Main trigger source.

Hysteresis Error (in seconds) = (Sensitivity/Slew) for negative going transitions with + slope or positive going transitions with - slope selected.

Table 4-1 (cont)
Electrical Specification

Characteristic	Performance Requirement
----------------	-------------------------

Counter/Timer (cont)

Definitions of Terms for the Counter/Timer (cont)

LSD = Least Significant Digit.

N = number of events in a measurement interval; selectable as 1, $\approx 10^2$, $\approx 10^4$, $\approx 10^6$, $\approx 10^8$, $\approx 10^{10}$, and Auto. For Auto Averaging, N is the greater of one or the number of events in a 300 ms interval.

n=number of events within the gate interval for gated measurements.

P = the period of the signal being measured ($P=1/F$).

Resolution = the amount an input signal must change to assure a change on the display.

Result = The measurement result.

Sensitivity = Trigger sensitivity, see TRIGGER specifications.

Slew = The absolute value of the Signal Slew rate (amplitude/second) at the trigger point.

Slew_D = Slew for Delay Trigger.

Slew_E = Slew at the Ending edge of a measurement.

Slew_M = Slew for Main Trigger.

Slew_S = Slew at the Starting edge of a measurement.

TBE = time-base error (see CT time-base spec).

TJE = Trigger Jitter Error (in seconds rms), which is $(en1^2 + en2^2 + en3^2)^{0.5}/\text{Slew}$.

TJE_A = CT External A Input Trigger Jitter Error.

TJE_B = CT External B Input Trigger Jitter Error.

TJE_D = Delayed Trigger Jitter Error (see TJE).

TJE_L = Trigger Jitter Error of the Leading edge.

TJE_M = Main Trigger Jitter Error (see TJE).

TABLE 4-1 (cont)
Electrical Specification

Characteristics	Performance Requirements
-----------------	--------------------------

Counter/Timer (cont)

Definitions of Terms for the Counter/Timer (cont)

TJE_T = Trigger Jitter Error of the Trailing edge.

TLE = Trigger Level Error; error resulting from the actual trigger point being different from the set trigger point.

TLE_M = Trigger Level Error of the Main Trigger.

TLE_D = Trigger Level Error of the Delayed Trigger.

Math Terms used in the preceding expressions

$\exp\{\}$ = exponentiates to the power given by the expression within the brackets.

$\text{Int}(\)$ = converts the expression within the parenthesis to the nearest integer of lesser or equal value (e.g., $\text{Int}(1.7)=1$ and $\text{Int}(-1.7)=-2$).

$\log(\)$ = computes the base 10 (common) logarithm of the expression within the parenthesis.

Table 4-1 (cont)
Electrical Specification

Characteristics	Performance Requirements
External Connectors	
Camera Power	
Connector Type	3-contact connector compatible with Tektronix C-50 series cameras.
Top Pin	+15 Volts.
Center Pin	Single Sequence Reset.
Bottom Pin	Ground.
CALIBRATOR	
Output Connector	Bnc and probe hook; also has adjacent grounding post.
Square Wave Mode	
Output Voltage and Current	5.0 V, or 500 mV $\pm 1\%$ into a 1 M Ω load; 500 mV or 50 mV $\pm 1.9\%$ into a 50 $\pm 0.5\%$ Ω load.
Polarity	Positive-going with baseline at 0 V.
Output Resistance	450 Ω $\pm 0.5\%$.
Repetition Frequency	100 Hz, 1 kHz, 10 kHz, 100 kHz.
Accuracy	$\pm 0.2\%$.
Rise Time	≤ 200 ns into ≤ 20 pf.
Aberrations	$\pm 1\%$ into ≤ 20 pf > 500 ns after square-wave transitions.
Symmetry	Duration of high portion of output cycle is 50% $\pm 0.5\%$ of output period.

TABLE 4-1 (cont)
Electrical Specification

Characteristics	Performance Requirements
External Connectors (cont)	
CALIBRATOR (cont)	
Fast Rise Mode	
Output Voltage Swing	≥0.5 V into open circuit with baseline at 0 V ±0.1 V.
Output Resistance	50Ω ±5%.
Transition Time (+Slope)	≤2 ns into 50Ω.
P-P Aberrations	≤20% into 50Ω.
Frequencies	100 Hz, 1 kHz, 10 kHz, 100 kHz, 1 MHz; ±0.2%.
Counter/Timer Signal Inputs	
COUNTER REF CLOCK In/Out	
Connector Type	Female bnc. Serves as both Clock In and Clock Out.
Clock In	A center frequency of 10 MHz. 0 dBm (0.63 V p-p) signal may be applied to the bnc when an external source is used, such as the Counter/Timer reference.
Clock Out	A 10 MHz TTL compatible signal is available when the internal time base is used as the time reference for the Counter. The TTL output level is in series with 50 ohms.

Table 4-1 (cont)
Electrical Specification

Characteristics	Performance Requirements
External Connectors (cont)	
Counter/Timer Signal Inputs (cont) EXTERNAL COUNTER INPUTS A & B Connectors	The Counter/Timer A and B external inputs share the front-panel bnc's with the External Trigger Inputs. A buffer amplifier splits the signal for connection to the A and B trigger generators and the Counter/Timer. The Counter/Timer outputs are connected to Schmitt trigger inputs of the Counter/Timer for conversion to logic signals.
Sensitivity	+1, +5 selection applies to the External source for the Main and Dly'd trigger generators and the Counter/Timer.
Divide by 1	100 mV p-p (dc to 100 MHz) increasing to 500 mV at 500 MHz.
Divide by 5	Multiply above voltages by 5.
Counter/Timer A & B Input Noise	<5 mV rms.
Counter/Timer External Trigger Level Readout Range	
Divide by 1	±0.5 Volt.
Divide by 5	±2.5 Volts.

TABLE 4-1 (cont)
Electrical Specification

Characteristics	Performance Requirements																				
External Connectors (cont)																					
Counter/Timer Signal Inputs (cont)																					
Counter/Timer External Level Accuracy	For signals with transition times of ≥ 10 ns.																				
Divide by 1 (Signal Amplitude within ± 1 V)	Within $\pm[3\%$ of setting $+4\%$ of p-p signal $+ 10$ mV $+ (0.5$ mV times passive probe attenuation factor)].																				
Divide by 5 (Signal Amplitude within ± 5 V)	Within $\pm[3\%$ of setting $+4\%$ of p-p signal $+ 50$ mV $+ (0.5$ mV times passive probe attenuation factor)].																				
Counter/Timer External Slope Selection	Conforms to the input signal waveform.																				
RS-232-C (DCE)																					
Connector Type	25 pin "D" type female connector configured as DCE (Data Communications Equipment).																				
Connector Pin Assignments	<table border="1"> <thead> <tr> <th align="left">Pin</th> <th align="left">Name</th> </tr> </thead> <tbody> <tr><td>1</td><td>Protective Ground (PGNO)</td></tr> <tr><td>2</td><td>Transmitted Data (TxD)</td></tr> <tr><td>3</td><td>Received Data (RxD)</td></tr> <tr><td>4</td><td>Request to Send (RTS)</td></tr> <tr><td>5</td><td>Clear to Send (CTS)</td></tr> <tr><td>6</td><td>Data Set Ready (DSR)</td></tr> <tr><td>7</td><td>Signal Ground (SGND)</td></tr> <tr><td>8</td><td>Data Carrier Detect (DCD)</td></tr> <tr><td>20</td><td>Data Terminal Ready (DTR)</td></tr> </tbody> </table>	Pin	Name	1	Protective Ground (PGNO)	2	Transmitted Data (TxD)	3	Received Data (RxD)	4	Request to Send (RTS)	5	Clear to Send (CTS)	6	Data Set Ready (DSR)	7	Signal Ground (SGND)	8	Data Carrier Detect (DCD)	20	Data Terminal Ready (DTR)
Pin	Name																				
1	Protective Ground (PGNO)																				
2	Transmitted Data (TxD)																				
3	Received Data (RxD)																				
4	Request to Send (RTS)																				
5	Clear to Send (CTS)																				
6	Data Set Ready (DSR)																				
7	Signal Ground (SGND)																				
8	Data Carrier Detect (DCD)																				
20	Data Terminal Ready (DTR)																				
	Configured as DCE.																				
	<table border="1"> <thead> <tr> <th align="left">Name</th> <th align="left">Direction</th> </tr> </thead> <tbody> <tr><td>PGNO</td><td>N/A</td></tr> <tr><td>TxD</td><td>to DCE</td></tr> <tr><td>RxD</td><td>from DCE</td></tr> <tr><td>RTS</td><td>to DCE</td></tr> <tr><td>CTS</td><td>from DCE</td></tr> <tr><td>DSR</td><td>from DCE</td></tr> <tr><td>SGND</td><td>N/A</td></tr> <tr><td>DCD</td><td>from DCE</td></tr> <tr><td>DTR</td><td>to DCE</td></tr> </tbody> </table>	Name	Direction	PGNO	N/A	TxD	to DCE	RxD	from DCE	RTS	to DCE	CTS	from DCE	DSR	from DCE	SGND	N/A	DCD	from DCE	DTR	to DCE
Name	Direction																				
PGNO	N/A																				
TxD	to DCE																				
RxD	from DCE																				
RTS	to DCE																				
CTS	from DCE																				
DSR	from DCE																				
SGND	N/A																				
DCD	from DCE																				
DTR	to DCE																				

Table 4-1 (cont)
Electrical Specification

Characteristics	Performance Requirements
External Connectors (cont)	
IEEE-488 (GPIB)	
Connector Type	24 pin female connector for connecting instrument to GPIB. Meets specification IEEE-488-1978.
TRIGGER READY OUTPUT	Single sequence armed indication.
Connector Type	Female bnc.
Low Level	Output between 0 V and +0.5 V. Maximum current sink is 8 mA.
High Level	Output between +2.4 V and +5.0 V. Maximum current sourcing is 0.4 mA.
TRIGGER RESET INPUT	Measurements or sweeps in progress are aborted, then restarted on a high to low transition. (If in Single sequence, the sequence is also armed.)
Connector Type	Female bnc.
Input	TTL compatible.
Minimum Pulse Width	10 μ s at 50% amplitude points.
Input Voltage	0 V to +5 V (dc plus peak ac).
SWEEP GATE Output	
Connector Type	Female bnc.
Output Voltage	2.4 V to 5 V positive-going pulse, starting at 0 V to 0.5 V.
Output Drive	Will supply 400 μ A during high state; will sink 2 mA during low state.

TABLE 4-1 (cont)
Electrical Specification

Characteristics	Performance Requirements
External Connectors (cont)	
MAIN SWEEP Output	
Connector Type	Female bnc.
Source	A horizontal sweep.
Polarity	Positive-going ramp with baseline at 0V ± 0.5 V into 1 M Ω load.
Rate of rise	
Into 50 Ω Load	25 mV/unit of time, set by the time base Time/div control, within 15%; 100 ns/div maximum.
Into 1 M Ω Load	0.5 V/unit of time, set by the time base Time/div control, within 10%; 1 μ s/div maximum.
Output Resistance	950 $\Omega \pm 10\%$.
Z-AXIS Input	
Connector Type	Female bnc.
Sensitivity	Positive voltage decreases intensity. +3 V blanks a maximum intensity trace. +3 V, dc to 15 MHz, modulates a normal intensity trace.
Input Resistance	6 k $\Omega \pm 10\%$.
Maximum Input Voltage	± 25 V peak. 25 V p-p ac at ≤ 10 kHz.
Propagation Delay	From input transition to On/Off ≤ 50 ns.

Table 4-1 (cont)
Electrical Specification

Characteristics	Performance Requirements
External Connectors (cont)	
LEFT VERTICAL OUT	
Connector Type	Female bnc.
Source	Display channel of left plug-in unit.
Output Voltage	100 mV/div $\pm 10\%$ into 1 M Ω . 50 mV/div $\pm 10\%$ into 50 Ω .
Offset	± 150 mV into 1 M Ω with no input at plug-in interface.
Bandwidth (Mainframe Only)	Dc to 100 MHz.
Output Impedance	50 Ω $\pm 10\%$.

TABLE 4-1 (cont)
Electrical Specification

Characteristics	Performance Requirements
Horizontal Deflection System	
Main Sweep Time-Base Range	1.5 s/div to 5 ns/div. 10X Mag extends maximum sweep rate to 0.5 ns/div.
Dly'd Sweep Time-Base Range	0.6 s/div to 5 ns/div. 10X Mag extends maximum sweep rate to 0.5 ns/div.
Main and Dly'd Sweep Accuracy	Measured centered vertically on the graticule. Time/div in any coarse or fine setting.
Unmagnified	
+15° C to +35° C	
1.5 s/div to 10 ns/div or 5 ns/div	±(0.7% of time interval plus 0.6% of full scale).
9.95 ns/div to 5.05 ns/div (fine settings)	±(2.4% of time interval plus 0.6% of full scale).
0° C ≤ T ≤ 15° C or 35° C < T ≤ 50° C	
1.5 s/div to 5 ns/div	Add 0.5% of time interval to 15° C to 35° C tolerance.
Magnified	
+15° C to +35° C	
150 ms/div to 2 ns/div	±(1.2% of time interval plus 0.6% of full scale).
1 ns/div or 500 ps/div	±(1.7% of time interval plus 0.6% of full scale).
1.99 ns/div to 505 ps/div (fine settings)	±(3.8% of time interval plus 0.7% of full scale).

Table 4-1 (cont)
Electrical Specification

Characteristics	Performance Requirements
Horizontal Deflection System (cont)	
Main and Dly'd Sweep Accuracy (cont) Magnified (cont) $0^{\circ} C \leq T < 15^{\circ} C$ or $35^{\circ} C < T \leq 50^{\circ} C$ 150 ms/div to 2 ns/div	Add 0.5% of time interval to $15^{\circ} C$ to $35^{\circ} C$ tolerance.
1.99 ns/div to 500 ps/div	Add 0.75% of time interval to $15^{\circ} C$ to $35^{\circ} C$ tolerance.
Time/div in FINE Position	Continuously variable and calibrated between Time/div settings. Extends slowest Main sweep speed to 1.5 s/div, slowest Dly'd sweep speed to 0.6 s/div. Fine increments are 1% of next faster coarse setting. For example, a setting between 2 and 5 μs would be in 20 μs increments from 5 μs to 2 μs .
10X Mag Registration	Within 0.4 div from graticule center at 1 ms Time/div setting (10X Mag On to 10X Mag Off).
HORIZONTAL POSition Range	Start of 1 ms/div sweep can be positioned from right of graticule center to at least 10 div left of graticule center. Some portion of the 1 ms/div sweep is always visible with 10X Mag Off.
Sweep Length	10 divisions minimum.
Match of Δ Horiz Cursor readout to crt graticule with cursors set to +4 div and -4 div at center horizontal graticule line.	± 0.05 div.

TABLE 4-1 (cont)
Electrical Specification

Characteristics	Performance Requirements
Horizontal Deflection System (cont)	
Numeric Range of Δ Horiz Cursors	± 10 times the Time/div setting.
Delta-Time Measurement Using Cursors	
Unmagnified	
+15° C to +35° C	
1.5 s/div to 10 ns/div or 5 ns/div	$\pm(0.5\%$ of time interval plus 0.3% of full scale).
9.95 ns/div to 5.05 ns/div (fine settings)	$\pm(2.2\%$ of time interval plus 0.5% of full scale).
0° C \leq T \leq 15° C or 35° C < T \leq 50° C	
1.5 s/div to 5 ns/div	Add 0.5% of time interval to 15° C to 35° C tolerance.
Magnified	Exclude first and last four divisions of sweep.
+15° C to +35° C	
150 ms/div to 2 ns/div	$\pm(1.0\%$ of time interval plus 0.3% of full scale).
1 ns/div or 500 ps/div	$\pm(1.4\%$ of time interval plus 0.5% of full scale).
1.99 ns/div to 505 ps/div (fine settings)	$\pm(3.6\%$ of time interval plus 0.6% of full scale).
0° C \leq T < 15° C or 35° C < T \leq 50° C	
150 ms/div to 2 ns/div	Add 0.5% of time interval to 15° C to 35° C tolerance.
1.99 ns/div to 500 ps/div	Add 0.75% of time interval to 15° C to 35° C tolerance.

Table 4-1 (cont)
Electrical Specification

Characteristics	Performance Requirements
Horizontal Deflection System (cont)	
Delta-Time Delay Using Delayed Sweep with both Delays set $\geq 2\%$ of Full Scale from Minimum Delay	
Accuracy	
Main Time/div ≤ 0.1 sec	
+15° C to +35° C	$\pm(0.3\%$ of time interval plus 0.1% of full scale).
0° C $\leq T < 15^\circ$ C or 35° C $< T \leq 50^\circ$ C	$\pm(0.5\%$ of time interval plus 0.1% of full scale).
Main Time/div 0.5 sec and 0.2 sec	
+15° C to +35° C	$\pm(0.8\%$ of time interval plus 0.1% of full scale).
0° C $\leq T < 15^\circ$ C or 35° C $< T \leq 50^\circ$ C	$\pm(1.3\%$ of time interval plus 0.1% of full scale).
Resolution	0.005% of full scale.
Range	± 10 times the Main Time/div setting.
Delay Accuracy of two different delay settings $\geq 1\%$ of full scale using one delayed sweep	$\pm(0.3\%$ of delay setting plus 0.6% of full scale).
Delay Jitter	Within 0.005% (one part or less in 20,000) of full scale plus 100 ps.
Delay-Time Range	0 to 10.0 times the Main Time/div setting. The main sweep triggering event is observable on the delayed sweep when delay is set to zero in Runs After Delay mode.

TABLE 4-1 (cont)
Electrical Specification

Characteristics	Performance Requirements
Horizontal Deflection System (cont)	
XY Operation Mainframe Only	
Numeric Position Range	± 4.0 times Size/div setting.
Visual Position Range	At least ± 3.9 div.
X-Axis Deflection Accuracy for Mainframe Only, CENTER and RIGHT Compartments	Compatible with 11000-Series Plug-in units.
X-Axis Low Frequency Linearity for CENTER & RIGHT Compartments	0.1 div or less compression or expansion of a 2 div, center-screen signal when positioned within the display area.
X-Axis Bandwidth for CENTER and RIGHT Compartments	Dc to 3 MHz. Checked using a standard plug-in with a bandwidth of dc to >100 MHz.
CENTER Compartment Phase Difference between X and Y Axes	$\leq 1^\circ$ from dc to 1 MHz; $\leq 3^\circ$ from 1 MHz to 2 MHz. Checked using a standard plug-in with a bandwidth of dc to >100 MHz.
CENTER Compartment Horiz Accuracy Using Cursors (XY Operation)	Refer to System Specification Section (page 4-42) under the category "Horizontal Deflection Accuracy (XY) of Center Plug-In".

Table 4-1 (cont)
Electrical Specification

Characteristics	Performance Requirements
Horizontal Deflection System (cont)	
Delta-Time Delay Using Delayed Sweep with both Delays set $\geq 2\%$ of Full Scale from Minimum Delay	
Accuracy	
Main Time/div ≤ 0.1 sec	
+15° C to +35° C	$\pm(0.3\%$ of time interval plus 0.1% of full scale).
0° C $\leq T < 15^\circ$ or 35° C $< T \leq 50^\circ$ C	$\pm(0.5\%$ of time interval plus 0.1% of full scale).
Main Time/div 0.5 sec and 0.2 sec	
+15° C to +35° C	$\pm(0.8\%$ of time interval plus 0.1% of full scale).
0° C $\leq T < 15^\circ$ or 35° C $< T \leq 50^\circ$ C	$\pm(1.3\%$ of time interval plus 0.1% of full scale).
Resolution	0.005% of full scale.
Range	± 10 times the Main Time/div setting.
Delay Accuracy of two different delay settings $\geq 1\%$ of full scale using one delayed sweep	$\pm(0.3\%$ of delay setting plus 0.6% of full scale).
Delay Jitter	Within 0.004% (one part or less in 25,000) of full scale plus 100 ps.
Delay-Time Range	0 to 10.0 times the Main Time/div setting. The main sweep triggering event is observable on the delayed sweep when delay is set to zero in Runs After Delay mode.

TABLE 4-1 (cont)
Electrical Specification

Characteristics	Performance Requirements	
Holdoff (cont)		
Minimum Holdoff Time for 2ns Step and Countdown	Main Time/div	Minimum Holdoff
	5 ns	3.00 μ s
	>5 ns to 10 ns	3.10 μ s
	>10 ns to 20 ns	3.20 μ s
	>20 ns to 50 ns	3.50 μ s
	>50 ns to 100 ns	4.30 μ s
	>100 ns to 200 ns	5.50 μ s
	>200 ns to 500 ns	9.80 μ s
	>500 ns to 1 μ s	16.0 μ s
	>1 μ s to 2 μ s	30.0 μ s
	>2 μ s to 5 μ s	78.0 μ s
	>5 μ s to 10 μ s	160 μ s
	>10 μ s to 20 μ s	300 μ s
	>20 μ s to 50 μ s	780 μ s
	>50 μ s to 100 μ s	1.60 ms
	>100 μ s to 200 μ s	3.00 ms
	>200 μ s to 500 μ s	7.80 ms
	>500 μ s to 1 ms	16.0 ms
	>1 ms to 2 ms	30.0 ms
	>2 ms to 5 ms	78.0 ms
	>5 ms to 10 ms	160 ms
	>10 ms to 20 ms	300 ms
	>20 ms to 50 ms	780 ms
	>50 ms to 100 ms	1.60 s ¹
	>100 ms to 200 ms	3.00 s ¹
	>200 ms to 500 ms	7.80 s ¹
	>500 ms	20.0 s ¹

¹Applies only to Countdown.

Table 4-1 (cont)
Electrical Specification

Characteristics	Performance Requirements
Holdoff	
Time Range	
Minimum	Main Time/div multiple of 1 or 2; greater of 1.25 x Time/div or 3.5 μ s. Main Time/div multiple of 5; greater of 2.5 x Time/div or 3.5 μ s.
Maximum	At least 20 x minimum.
2 ns Step	
Minimum Range	See "Minimum Holdoff for 2 ns Step, Countdown, and Events" that follows.
Maximum Range	>0.99 sec.
Resolution	1.8 ns.
Countdown	
Minimum Range	See "Minimum Holdoff for 2 ns Step, Countdown, and Events" that follows.
Maximum Event Frequency	100 MHz.
Main Swp Start Jitter	400 ps.
Holdoff by Events	
Minimum Number of Events	2.
Maximum Number of Events	>500,000.
Maximum Count Frequency	
One Start Off	500 MHz.
One Start On	100 MHz.

TABLE 4-1 (cont)
Electrical Specification

Characteristics	Performance Requirements
Holdoff (cont)	
Holdoff by Events (cont)	
Start Event to Count Event	
Main Trig to Dly Trig	
Setup Time	1 ns.
Hold Time	-1 ns.
Main Trig to CT B Ext	
Setup Time	6.5 ns.
Hold Time	-4.5 ns.
CT A Ext to Main Trig	
Setup Time	-1.5 ns.
Hold Time	3.5 ns.
A Ext to Dly1 Trig	
Setup Time	-1.5 ns.
Hold Time	3.5 ns.
CT A Ext to CT B Ext	
Setup Time	1 ns.
Hold Time	-1 ns.
Setup Time, Last Count to Main Trig	26 ns.
Main Sweep Start Jitter	
One Start On	400 ps.
One Start Off	4 ns.

Table 4-1 (cont)
Electrical Specification

Characteristics	Performance Requirements	
Holdoff (cont)		
Minimum Holdoff Time for 2ns Step and Countdown	Main Time/div	Minimum Holdoff
	5 ns to 50 ns	3.50 μ s
	>50 ns to 100 ns	3.50 μ s
	>100 ns to 200 ns	3.50 μ s
	>200 ns to 500 ns	9.80 μ s
	>500 ns to 1 μ s	16.0 μ s
	>1 μ s to 2 μ s	30.0 μ s
	>2 μ s to 5 μ s	78.0 μ s
	>5 μ s to 10 μ s	160 μ s
	>10 μ s to 20 μ s	300 μ s
	>20 μ s to 50 μ s	780 μ s
	>50 μ s to 100 μ s	1.60 ms
	>100 μ s to 200 μ s	3.00 ms
	>200 μ s to 500 μ s	7.80 ms
	>500 μ s to 1 ms	16.0 ms
	>1 ms to 2 ms	30.0 ms
	>2 ms to 5 ms	78.0 ms
	>5 ms to 10 ms	160 ms
	>10 ms to 20 ms	300 ms
	>20 ms to 50 ms	780 ms
	>50 ms to 100 ms	1.60 s ¹
	>100 ms to 200 ms	3.00 s ¹
	>200 ms to 500 ms	7.80 s ¹
	>500 ms	20.0 s ¹

¹Applies only to Countdown.

TABLE 4-1 (cont)
Electrical Specification

Characteristics	Performance Requirements
Triggering, Main and Dly'd	
Minimum P-P Signal Amplitude for Stable Sweep Triggering	Upper frequency limitation depends on plug-in unit. The upper frequency limits listed below apply when using an 11A71 amplifier.
High Sensitivity	
Dc Coupled	0.35 div from dc to ≤ 50 MHz; increasing to 1.0 div from >50 MHz to 500 MHz.
Ac Coupled	0.35 div from 50 Hz to ≤ 50 MHz; increasing to 1.0 div from >50 MHz to 500 MHz. Attenuates signals below 50 Hz.
HF Reject Coupled	0.50 div to 30 kHz.
LF Reject Coupled	0.50 div from 80 kHz to ≤ 50 MHz; increasing to 1.0 div from >50 MHz to 500 MHz.
Medium Sensitivity	Multiply high sensitivity requirements by 2.
Low Sensitivity	Multiply high sensitivity requirements by 3.
Minimum P-P Signal Amplitude for Stable Sweep Triggering from Composite or Multiple Channel Source	Add 1.0 div to above specifications.

Table 4-1 (cont)
Electrical Specification

Characteristics	Performance Requirements
Triggering, Main and Dly'd (cont)	
Minimum P-P Signal Amplitude Required for Stable Sweep Triggering from A or B External Inputs High Sensitivity Divide by 1 Input Sensitivity Dc Coupled	≤ 20 mV from dc to ≤ 50 MHz; increasing to ≤ 60 mV from > 50 MHz to 300 MHz; and ≤ 90 mV from > 300 MHz to 500 MHz.
Ac Coupled	≤ 20 mV from 50 Hz to ≤ 50 MHz; increasing to ≤ 60 mV from > 50 MHz to 300 MHz; and ≤ 90 mV from > 300 MHz to 500 MHz. Attenuates signal below 50 Hz.
HF Reject Coupled	≤ 28 mV from dc to 30 kHz.
LF Reject Coupled	≤ 28 mV from 80 kHz to ≤ 50 MHz; increasing to ≤ 60 mV from > 50 MHz to 300 MHz; and ≤ 90 mv from > 300 MHz to 500 MHz.
Divide by 5 Input Sensitivity	Multiply above voltages by 5.
Medium Sensitivity	Multiply figures for high sensitivity by 2.
Low Sensitivity	Multiply figures for high sensitivity by 3.
Jitter	< 600 ps Total (peak to peak) with 5 divisions of amplitude at 300 MHz with Time/div set to 5 ns and 10X Mag On.

TABLE 4-1 (cont)
Electrical Specification

Characteristics	Performance Requirements
Triggering, Main and Dly'd (cont)	
Triggering LEVEL Control Range	
LEFT or CENTER Plug-In	±10 times Size/div setting.
A, B External Inputs	
Divide by 1 Sensitivity	±500 mV.
Divide by 5 Sensitivity	±2.5 V.
Trigger LEVEL Readout Accuracy	
LEFT or CENTER Plug-in	Depends on plug-in unit and probe being used. See "System Accuracy Specification."
Single Plug-In Channel Signal Source	See "System Specification."
A or B External Input	For triggering signals with 10 to 90% transition times greater than 10 ns.
Divide by 1 Max Signal ±1 V	Within ±[3.0% of setting plus 4% of p-p signal plus 10 mV plus (0.5 mV times probe attenuation factor)].
Divide by 5 Max Signal ±5 V	Within ±[3.0% of setting plus 4% of p-p signal plus 50 mV plus (0.5 mV times probe attenuation factor)].
Slope Selection	Conforms to trigger-source waveform at input connector or ac power-source waveform.
P-P and Auto Mode Triggering Signal Period	≤50 ms.
Line Trigger Level Range	Sufficient to trigger at positive and negative peaks of ac power source waveform.
Trigger Noise (Mainframe only)	0.05 div rms.
Measurement Accuracy	See "System Specification."

Table 4-1 (cont)
Electrical Specification

Characteristics	Performance Requirements
Triggering, Main and Dly'd (cont)	
Minimum P-P Signal Amplitude Required for Stable Sweep Triggering from A or B External Inputs High Sensitivity Divide by 1 Input Sensitivity Dc Coupled	≤ 20 mV from dc to ≤ 50 MHz; increasing to ≤ 60 mV from >50 MHz to 300 MHz; and ≤ 90 mV from >300 MHz to 500 MHz.
Ac Coupled	≤ 20 mV from 50 Hz to ≤ 50 MHz; increasing to ≤ 60 mV from >50 MHz to 300 MHz; and ≤ 90 mV from >300 MHz to 500 MHz. Attenuates signal below 50 Hz.
HF Reject Coupled	≤ 28 mV from dc to 30 kHz.
LF Reject Coupled	≤ 28 mV from 80 kHz to ≤ 50 MHz; increasing to ≤ 60 mV from >50 MHz to 300 MHz; and ≤ 90 mv from >300 MHz to 500 MHz.
Divide by 5 Input Sensitivity	Multiply above voltages by 5.
Medium Sensitivity	Multiply figures for high sensitivity by 2.
Low Sensitivity	Multiply figures for high sensitivity by 3.
Jitter	< 50 ps rms with 5 divisions of amplitude at 300 MHz with Time/div set to 5 ns and 10X Mag On.

TABLE 4-1 (cont)
Electrical Specification

Characteristics	Performance Requirements
Triggering, Main and Dly'd (cont)	
Triggering LEVEL Control Range	
LEFT or CENTER Plug-In	±10 times Size/div setting.
A, B External Inputs	
Divide by 1 Sensitivity	±500 mV.
Divide by 5 Sensitivity	±2.5 V.
Trigger LEVEL Readout Accuracy	
LEFT or CENTER Plug-in	Depends on plug-in unit and probe being used. See "System Accuracy Specification."
Single Plug-In Channel Signal Source	See "System Specification."
A or B External Input	For triggering signals with 10 to 90% transition times greater than 10 ns.
Divide by 1 Max Signal ±1 V	Within ±[3.0% of setting plus 4% of p-p signal plus 10 mV plus (0.5 mV times probe attenuation factor)].
Divide by 5 Max Signal ±5 V	Within ±[3.0% of setting plus 4% of p-p signal plus 50 mV plus (0.5 mV times probe attenuation factor)].
Slope Selection	Conforms to trigger-source waveform at input connector or ac power-source waveform.
P-P and Auto Mode Triggering Signal Period	≤50 ms.
Line Trigger Level Range	Sufficient to trigger at positive and negative peaks of ac power source waveform.
Trigger Noise (Mainframe only)	0.05 div rms.
Measurement Accuracy	See "System Specification."

Table 4-1 (cont)
Electrical Specification

Characteristics	Performance Requirements
Vertical Deflection System	
Deflection Factor	Compatible with 11A-series plug-in units.
Accuracy, with 11000-Series Plug-ins	See System Accuracy Specification tables.
Match of ΔV Cursor readout to crt graticule with Cursors set to +3 div and -3 div at center vertical graticule line.	± 0.05 div.
Numeric Range of ΔV Cursors	± 8 times the Size/div setting.
DC Accuracy Using Cursors	See System Accuracy in Specification tables.
Channel Isolation (between LEFT and CENTER plug-ins)	$\geq 100:1$ attenuation of unselected channel at ≤ 100 Mhz; $\geq 50:1$ at ≤ 300 MHz, for an 8 div input signal.
Delay Between Channels (display only)	1.0 ns range of adjustment.
Low-Frequency Linearity	0.1 div or less compression or expansion of a 2 div, center-screen signal when positioned anywhere within the graticule area.
Vertical Signal Delay	
≥ 10 ns/div unmagnified or ≥ 1 ns/div magnified	At least 30 ns of the sweep is displayable before the triggering event is displayed.
5 ns/div to 9.95 ns/div unmagnified or 500 ps/div to 995 ps/div magnified	At least 15 ns of the sweep is displayable before the triggering event is displayed. Test plug-in must have ± 100 ps match between vertical and trigger signal outputs.

TABLE 4-1 (cont)
Electrical Specification

Characteristics	Performance Requirements
Vertical Deflection System (cont)	
Chopped Mode Switching Rate	<p>Vertical display switches sequentially through the selected channels at the chop switching rate. The chop switching rate is 1 MHz \pm10.0% (dual channel switching rate is 500 kHz \pm10.0%.</p> <p>The chop switching rate is asynchronous to the sweep frequency, to minimize waveform breaks when viewing repetitive signals.</p>
Vertical Trace Visual Positioning Range	<p>At least \pm3.9 divisions.</p> <p>Plug-in signal is applied to exactly center trace when position readout is equal to zero.</p>
Vertical Trace Positioning Numeric Range	\pm 4.0 divisions.

Environmental Characteristics

TABLE 4-2
Environmental Characteristics

The test result is highly dependent on procedure. For customer verification of environmental performance, refer to the listed government/industry document for test methods. Tektronix internal verification procedures are in some cases more stringent than contained in the listed standards. Tektronix standards may be proved to customers on request.

Under MIL-T-28800, the instrument is classified as Type III, Class 5, Style E. Only those requirements from MIL-T-28800 that are listed apply.

"Nonoperating" means the PRINCIPAL POWER SWITCH on the rear panel of the instrument is set to OFF, or the power cord is disconnected.

Characteristics	Information
Temperature	
Operating	0° C to +50° C.
Storage	-40° C to +75° C.
Humidity	
Operating and Storage	5 days, per MIL-T-28800C, Type III, Class 5.
Altitude	
Operating	To 4.57 km (15,000 feet).
Storage	To 15.18 km (50,000 feet).
Vibration	
Operating and Nonoperating	Tested to MIL-T-28800C, SECT. 4.5.5.3.1, Type III, Class 5.
Shock	
Nonoperating	Tested to MIL-T-28800C, SECT. 4.5.5.4.1, Type III, Class 5.
Bench Handling	
Operating	Tested to MIL-T-28800C, SECT. 4.5.5.4.3, Type III, Class 5.

TABLE 4-2 (cont)
Environmental Characteristics

Characteristics	Information
Transportation	
Vibration and Bounce of packaged product	Meets ASTM D999-75, Method A, Paragraph 3.1, (NSTA Project 1A-B-1).
Drop of Packaged Product	Meets ASTM D775-61, Method 1, Paragraph 5. (NSTA, Project 1A-B-2).
Electromagnetic Immunity	
Operating	0-15 kV with no performance degradation. 0-20 kV with no instrument damage.
Electromagnetic Compatibility	
United States	Tested to MIL-T-28800C; MIL-STD-461B; FCC Part 15, Subpart J, Class B; VDE 0871, Class B; CE-01, Part 4 (with exceptions); CE-03, Part 4, Curve 1; CE-03, Part 4, Curve 4, Navy, NB, BB (with exceptions); CS-01, Part 7; CS-02, Part 4 (with exceptions); CS-06, Part 5; RE-01, Part 4 (with exceptions); RE-02, Part 4; RS-01, Part 4; RS-03, Part 7, (limited to 1 GHz).
United States FCC	Part 15, Subpart J, Class A.
Germany	Tested to VDE 0871/6.78, Class B.

Physical Characteristics

TABLE 4-3
Physical Characteristics

Characteristics	Information
Weight	
11301	198 nt (44 lbs) without plug-ins.
11302	196 nt (44 lbs) without plug-ins.
Mass	
11301	20.24 kg (1.39 slug) without plug-ins.
11302	19.96 kg (1.37 slug) without plug-ins.
Shipping Weight/Mass	
Domestic	266 nt (59.8 lbs). 27.13 kg (1.87 slug).
Cooling	Forced-air circulation using a variable speed (based on temperature) exhaust fan. All plug-in compartments must be filled. For unused compartments, install a blank plug-in unit (Tektronix Part No. 016-0829-00).
Finish	Blue painted aluminum cabinet.
Construction	Aluminum-alloy chassis (sheet metal). Die-cast aluminum front and rear subpanel. Glass-laminate circuit boards.

Dimensional Drawings

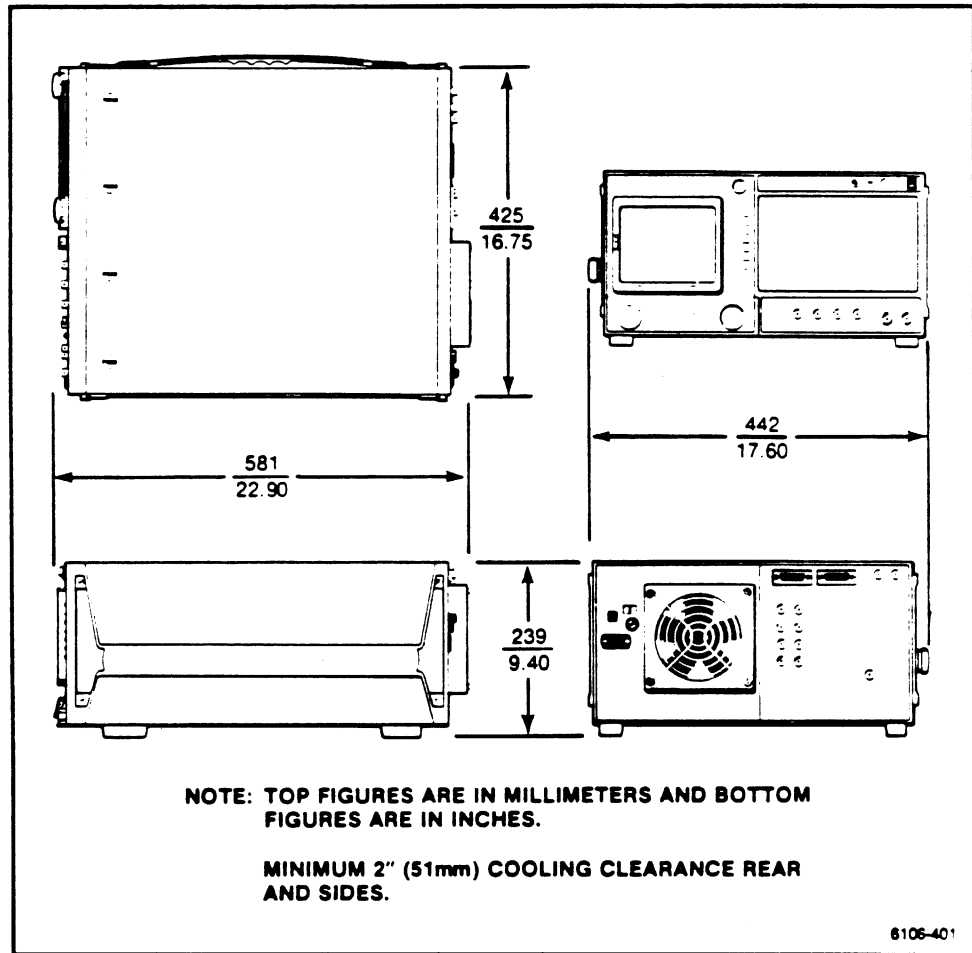

Figure 4-1. Bench Model.

The same outside dimensions apply to the 11302 Oscilloscope.

Physical Characteristics

TABLE 4-3
Physical Characteristics

Characteristics	Information
Weight	
11301	198 nt (44 lbs) without plug-ins.
11302	196 nt (44 lbs) without plug-ins.
Mass	
11301	20.24 kg (1.39 slug) without plug-ins.
11302	19.96 kg (1.37 slug) without plug-ins.
Shipping Weight/Mass	
Domestic	266 nt (59.8 lbs). 27.13 kg (1.87 slug).
Cooling	Forced-air circulation using a variable speed (based on temperature) exhaust fan.
Finish	Blue painted aluminum cabinet.
Construction	Aluminum-alloy chassis (sheet metal). Die-cast aluminum front and rear subpanel. Glass-laminate circuit boards.

Dimensional Drawings

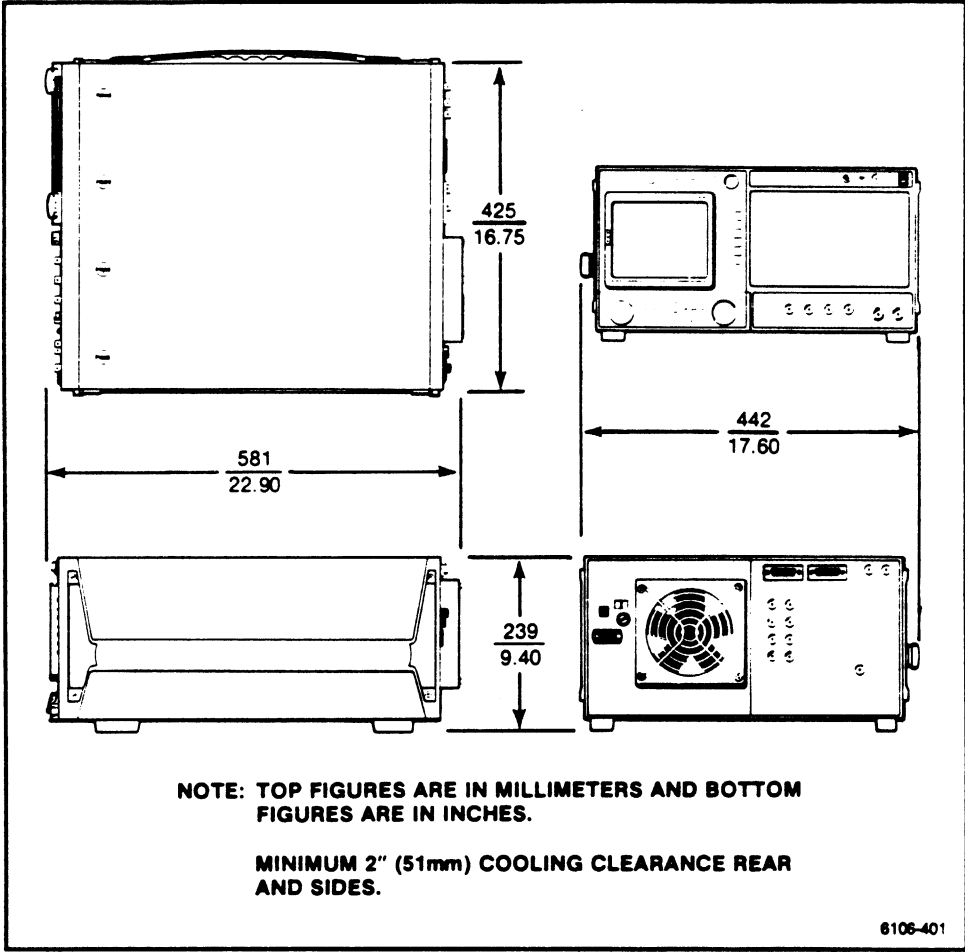

Figure 4-1. Bench Model.

The same outside dimensions apply to the 11302 Oscilloscope.

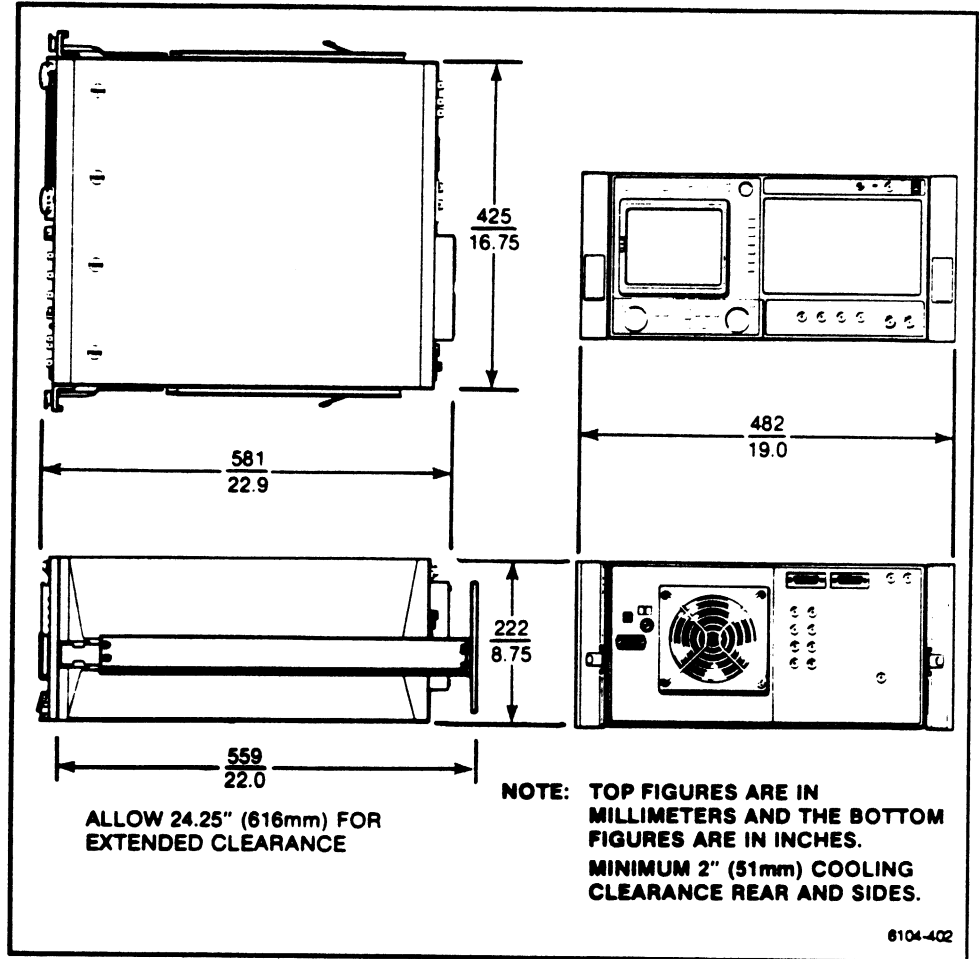

Figure 4-2. Rackmount Model.

The same outside dimensions apply to the 11302 Oscilloscope.

System Specification

The plug-in bandwidth may be restricted depending upon which 11000-Series mainframe it is installed in. Check Table 4-8 find the system bandwidth for the plug-in and mainframe combination you wish to use.

Vertical Bandwidth

TABLE 4-4
System Bandwidth and Rise Time

Specified System Bandwidth (0 to 35° C)
Rise Time Cal, 0.35/BW

Plug-in	Deflection Factor	11301	11302
11A71	all V/div	400 MHz 0.9 ns	500 MHz 0.7 ns
11A52	≥10 mV/div	350 MHz 1.0 ns	400 Mhz 0.9 ns
	5 mV to 9.95 mV/div	350 Mhz 1.0 ns	400 MHz 0.9 ns
	2 mV to 4.98 mV/div	300 MHz 1.2 ns	300 Mhz 1.2 ns
	1 mV to 1.99 mV/div	200 Mhz 1.8 ns	250 MHz 1.4 ns
11A32	≥10 mV/div	300 MHz 1.2 ns	350 MHz 1.0 ns
	5 mV to 9.95 mV/div	300 MHz 1.2 ns	300 MHz 1.2 ns
	2 mV to 4.98 mV/div	250 MHz 1.4 ns	250 MHz 1.4 ns
	1 mV to 1.99 mV/div	200 MHz 1.8 ns	200 MHz 1.8 ns
11A34	≥10 mV/div	250 MHz 1.4 ns	250 MHz 1.4 ns
	5 mV to 9.95 mV/div	250 MHz	250 MHz
	2 mV to 4.98 mV/div	200 MHz 1.8 ns	250 MHz 1.4 ns
	1 mV to 1.99 mV/div	200 MHz 1.8 ns	200 MHz 1.8 ns

**Dc Vertical
Accuracy
Using Cursors**

**TABLE 4-5
Accuracy with 11A71 Amplifier**

11A71 with the 11301/11302 Mainframes.
Accuracy of On Screen Cursor Readings with position set to 0.00

Enhanced Accuracies Without Probes

Deflection Factor	Delta-V DC Accuracy	DC Balance	DC Offset Accuracy
10 mV/div to 1 V/div	$\pm(0.9\% + 0.05 \text{ div})$	$\pm 0.2 \text{ div}$	$\pm(0.20\% + 0.01 \text{ div})$

Enhanced Accuracies With P6231 450- Ω Bias/Offset 10X Active Probe

Deflection Factor	Delta-V DC Accuracy	DC Balance	DC Offset Accuracy
100 mV/div to 1 V/div	$\pm(1.6\% + 0.05 \text{ div})$	$\pm 0.2 \text{ div}$	$\pm(0.15\% + 3.8 \text{ mV})$
Probe Tip TC terms	100 ppm/DegC		

**TABLE 4-6
Accuracy with 11A52 Two Channel Amplifier**

11A52 with the 11301/11302 Mainframes (with on screen cursors).

Enhanced Accuracies Without Probes

Deflection Factor	Delta-V DC Accuracy	DC Balance	DC Offset Accuracy
1 mV/div to 99.5 mV/div	$\pm(1.0\% + 0.04 \text{ div})$	$\pm(0.2 \text{ mV} + 0.13 \text{ div})$	$\pm 0.15\% + 0.75 \text{ mV}$
100 mV/div to 995 mV/div	$\pm(1.0\% + 0.04 \text{ div})$	$\pm(2 \text{ mV} + 0.13 \text{ div})$	$\pm(0.20\% + 7.5 \text{ mV})$
1 V/div to 10V/div	$\pm(1.0\% + 0.04 \text{ div})$	$\pm(20 \text{ mV} + 0.13 \text{ div})$	$\pm(0.20\% + 75 \text{ mV})$

Enhanced Accuracies With P6231 450- Ω Bias/Offset 10X Active Probe

Deflection Factor	Delta-V DC Accuracy	DC Balance	DC Offset Accuracy
10 mV/div to 995 mV/div	$\pm(1.1\% + 0.04 \text{ div})$	$\pm(2 \text{ mV} + 0.13 \text{ div})$	$\pm(0.15\% + 3.8 \text{ mV})$
$\geq 1 \text{ V/div}$	$\pm(1.7\% + 0.04 \text{ div})$	$\pm(20 \text{ mV} + 0.13 \text{ div})$	$\pm(0.15\% + 3.8 \text{ mV})$
Probe Tip TC terms -	100 ppm/Deg C		

TABLE 4-7
Accuracy with 11A32 Two Channel Amplifier
and 11A34 Four Channel Amplifier

11A32/11A34 Plug Ins with the 11301/11302 Mainframes (with on screen cursors).

Enhanced Accuracies Without Probes

Deflection Factor	Delta-V DC Accuracy	DC Balance	DC Offset Accuracy
1 mV/div to 99.5 mV/div	$\pm(1.0\% + 0.04 \text{ div})$	$\pm(1.0 \text{ mV} + 0.13 \text{ div})$	$\pm 0.2\% + 0.8 \text{ mV}$
100 mV/div to 995 mV/div	$\pm(1.0\% + 0.04 \text{ div})$	$\pm(10 \text{ mV} + 0.13 \text{ div})$	$\pm 0.25\% + 8 \text{ mV}$
1 V/div to 10 V/div	$\pm(1.0\% + 0.04 \text{ div})$	$\pm(100 \text{ mV} + 0.13 \text{ div})$	$\pm 0.25\% + 80 \text{ mV}$

Enhanced Accuracies with P6134 10-M Ω Passive 10X Probe

Deflection Factor	Delta-V DC Accuracy	DC Balance	DC Offset Accuracy
10 mV/div to 995 mV/div	$\pm(1.0\% + 0.04 \text{ div})$	$\pm(12 \text{ mV} + 0.13 \text{ div})$	$\pm(0.25\% + 8 \text{ mV})$
1 V/div to 9.95 V/div	$\pm(1.5\% + 0.04 \text{ div})$	$\pm(120 \text{ mV} + 0.13 \text{ div})$	$\pm(0.75\% + 80 \text{ mV})$
10 V/div to 100V/div	$\pm(1.5\% + 0.04 \text{ div})$	$\pm(1.2 \text{ V} + 0.13 \text{ div})$	$\pm(0.75\% + 0.8 \text{ V})$
Probe Tip TC terms	100 ppm/Deg C		

Enhanced Accuracies With P6231 450- Ω Bias/Offset 10X Active Probe

Deflection Factor	Delta-V DC Accuracy	DC Balance	DC Offset Accuracy
10 mV/div to 995 mV/div	$\pm(1.1\% + 0.04 \text{ div})$	$\pm(10 \text{ mV} + 0.13 \text{ div})$	$\pm(0.2\% + 3.8 \text{ mV})$
$\geq 1 \text{ V/div}$	$\pm(1.1\% + 0.04 \text{ div})$	$\pm(100 \text{ mV} + 0.13 \text{ div})$	$\pm(0.2\% + 3.8 \text{ mV})$
Probe Tip TC terms	100 ppm/DegC		

**Horizontal
Deflection
Accuracy (XY) of
Center Plug-in**

Horizontal deflection dc accuracy using cursors from the center plug-in depends on the plug-in and probe in use. For a single plug-in channel signal source with Dc coupling, calculate the allowed tolerance using the terms for the vertical system with the following modifications: add 0.5% to the "Delta-V DC Accuracy" term and add 0.1 div to the "DC Balance" term.

Measurement Accuracy

Measurement accuracy depends on plug-in and probe use, using a single plug-in channel and signals with amplitudes of $\leq \pm 8$ divisions of relative to the plug-in offset and with a rise time of >10 times the system rise time, and dc input coupling.

For the MIN or MAX measurement, calculate the ground-referenced accuracy of the Vertical system; add 3% and 0.1 div to the Delta-V DC term, where delta-V is the MIN or MAX value minus the amplifier offset; add 0.4 div to the DC Balance term; and add peak noise in divs.

For the P-P measurement, calculate the differential accuracy of the vertical system; add 3% and 0.4 div to the Delta-V DC term, where delta-V is the p-p voltage; and add p-p noise in divs.

Trigger Level Readout Accuracy

Trigger level readout dc accuracy depends on the plug-in and probe in use. For a single plug-in channel signal source with Dc coupling, calculate the ground-referenced accuracy using the terms for the vertical system with the following modifications: add 2% to the "Delta-V DC Accuracy" term, where delta-V is the (Level readout – Amplifier offset) divided by Volts/div; add 0.3 div to the "DC Balance" term; add peak noise in divs.

Section 5

Instrument Options

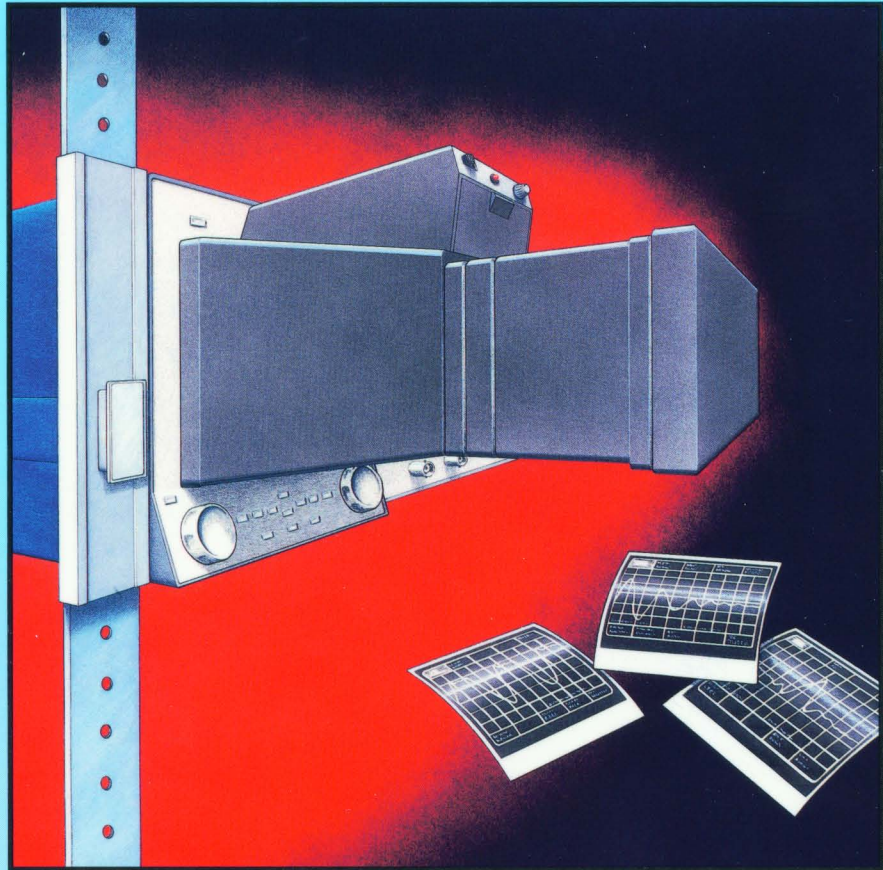

Contents

Instrument Option Identification.....	5-1
Option 1C.....	5-1
Option 1R.....	5-1
Option 1T.....	5-1
Option A1.....	5-1
Option A2.....	5-1
Option A3.....	5-1
Option A4.....	5-1
Option A5.....	5-1
Option Information Locator.....	5-2

Instrument Options

Your instrument may be equipped with one or more instrument options. A brief description of each available option is given in the following discussion. Option information is incorporated into the appropriate sections of the manual. Refer to Table 5-1 and the Table of Contents for location of option information. For further information on instrument options, see your Tektronix Products catalog or contact your Tektronix Field Office.

WARNING

To avoid electric shock hazard, operating personnel must not remove the protective instrument covers. Component replacement and internal adjustments must be made by qualified service personnel only.

Instrument Option Identification

- Option 1C** Option 1C adds 8 bnc connectors to the front- and rear-panels so that signals may be internally routed directly between the two panels. This is especially useful for rackmounted applications. This option can be added at any time.
- Option 1R** Option 1R adds side rails and rackmounting hardware to convert the benchtop instrument to a standard 19-inch rackmount version. This option can be added at any time.
- Option 1T** Option 1T provides a high-stability time base for the Counter Timer. This option can be added at any time.
- Option A1** The standard power cord is replaced with the Universal European 220-volt type power cord.
- Option A2** The standard power cord is replaced with the United Kingdom 240-volt type power cord.
- Option A3** The standard power cord is replaced with the Australian 240-volt type power cord.
- Option A4** The standard power cord is replaced with the North American 250-volt type power cord.
- Option A5** The standard power cord is replaced with the Switzerland 240-volt type power cord.

TABLE 5-1
Option Information Locator

Option	Location in Manual		Information
	Section	Heading	
Option 1C (Provides front to rear bnc connectors)	5 Instrument Options	Option 1C	Gives a brief description of Option 1C
Option 1R (Provides rack-mount hardware)	5 Instrument Options	Option 1R	Gives a brief description of Option 1R.
Option 1T (Provides high-stability time base)	5 Instrument Options	Option 1T	Gives a brief description of Option 1T.
A1 Option (Provides Universal European power cord)	1 Installation	Power-Cord and Plug Identification Table 1-2	Lists details of Option A1.
	5 Instrument Options	Option A1	Gives a brief description of Option A1.
A2 Option (Provides United Kingdom power cord)	1 Installation	Power-Cord and Plug Identification Table 1-2	Lists details of Option A2.
	5 Instrument Options	Option A2	Gives a brief description of Option A2.
A3 Option (Provides Australian power cord)	1 Installation	Power Cord and Plug Identification Table 1-2	Lists details of Option A3.
	5 Instrument Options	Option A3	Gives a brief description of Option A3.

TABLE 5-1 (cont)
Option Information Locator

Option	Location in Manual		Information
	Section	Heading	
A4 Option (Provides North American power cord)	1 Installation	Power-Cord and Plug Identification Table 1-2	Lists details of Option A4.
	5 Instrument Options	Option A4	Gives a brief description of Option A4.

Section 6

Plug-In Unit Information

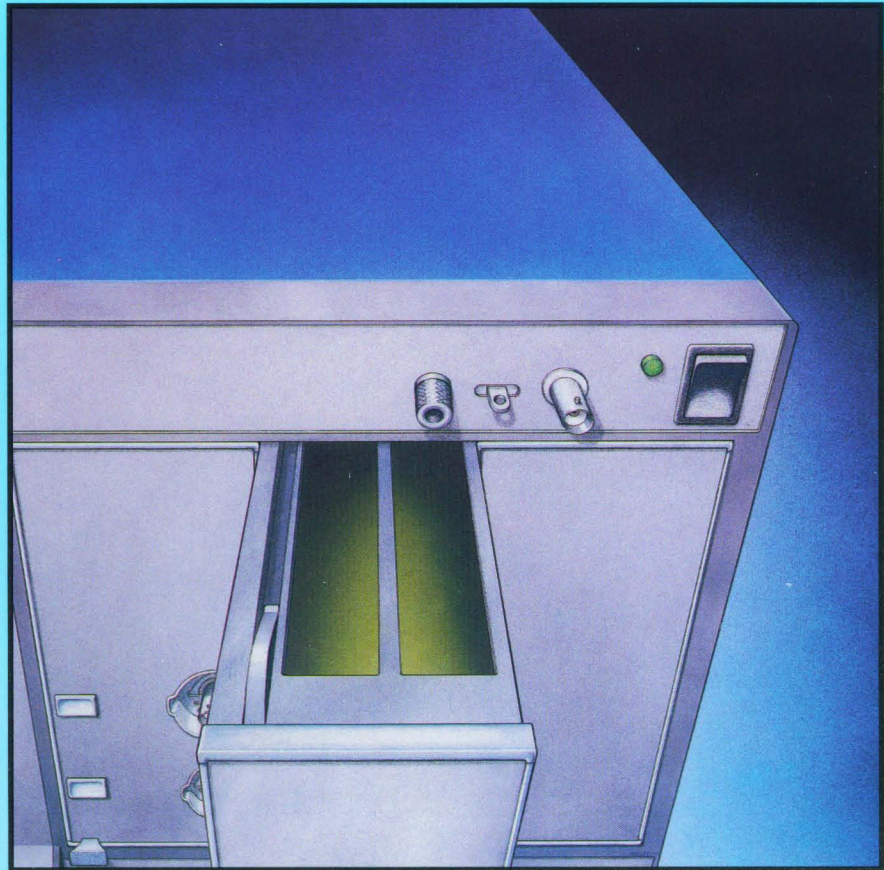

11A32 Two Channel Amplifier

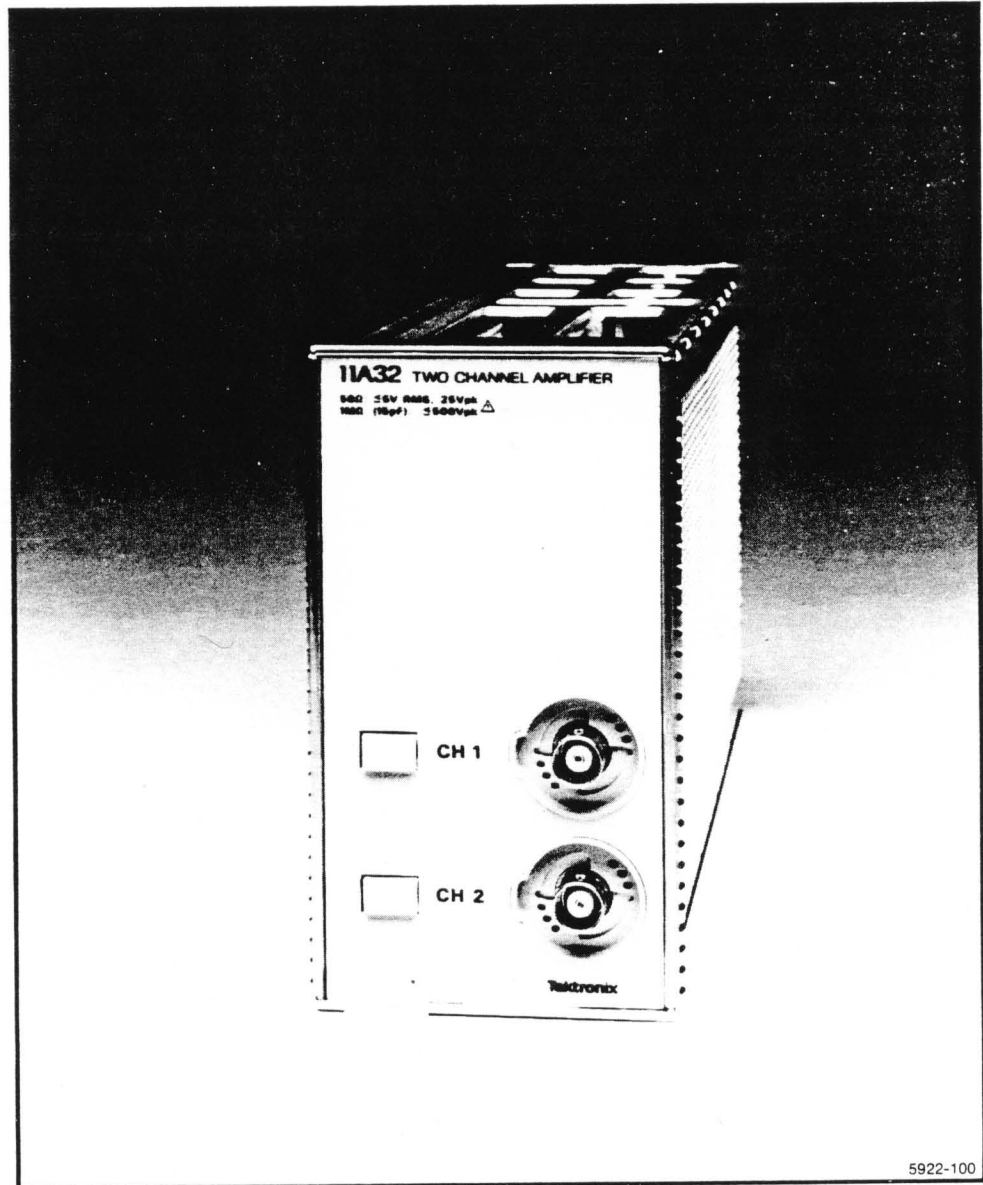

11A32 Features and Functions

Features

- Dual trace
- Up to 350 MHz bandwidth (in 11302)
- Calibrated sensitivities from 1 mV to 10 V/division
- 50 Ω or 1 M Ω input impedance
- High-resolution, calibrated DC offset (0.25 division/increment, coarse; 0.025 division/increment, fine)
- Fast overdrive recovery

Functions

Signals applied to the CH 1 and CH 2 input connectors can be displayed or removed from the display by pressing the display on/off buttons adjacent to the input connectors.

All other 11A32 functions are controlled through the host mainframe. Such mainframe-controlled functions are:

- Sensitivity, Coarse and Fine, over a range of 1 mV to 10 V/division.
- Vertical Offset.
- Coupling: Ac, Dc, or Off.
- Impedance (input termination): 50 Ω or 1 M Ω .
- HF Limit: 100 MHz or 20 MHz.
- Display Polarity: normal or inverted.
- Trigger Polarity: normal or inverted.
- Combination of Display Channels: see Operating Information section of mainframe User's Reference manual.
- Combination of Trigger Channels: same as Display Channels; see Operating Information section of mainframe User's Reference manual.

Contents

Part 1—General Information

Technical Manuals.....	1-1
Contents of this Supplement.....	1-1
11A32 Service Manual.....	1-2
Plug-in to Mainframe Compatibility.....	1-2
Initial Inspection.....	1-2
Operating Temperature.....	1-3
Installing and Removing the 11A32.....	1-3
Instrument Options.....	1-4
Packaging for Shipment.....	1-5

Part 2—Operating the 11A32 in 11301 and 11302 Mainframes

Display On/Off.....	2-1
Selecting Coupling, HF Limit, and Impedance.....	2-1
Other Functions.....	2-2
Position and Offset.....	2-2
HF Limit.....	2-3
DC Circuit Loading.....	2-3
Adding and Subtracting Waveforms.....	2-4
Overdrive Recovery.....	2-4
50 Ω Overload.....	2-7
Active Probes.....	2-7
Probe ID.....	2-7
Front-Panel Error Messages.....	2-8
GPIB and RS-232-C Commands and Syntax.....	2-9

Part 3—Specification

Performance Conditions.....	3-1
Electrical Characteristics.....	3-1
Environmental Characteristics.....	3-7
Physical Characteristics.....	3-8
Recommended Probes.....	3-8

Appendix A—Glossary.....	A-1
--------------------------	-----

Illustrations

1-1	Installing a plug-in unit in a mainframe oscilloscope.....	1-4
2-1	Location of AC coupling capacitors in plug-in amplifiers.....	2-3
2-2	Overdrive recovery using long (top) and short (bottom) cables terminated in 50Ω. Traces are offset two divisions and the photograph is a double exposure.....	2-5
2-3	Overdrive recovery using long (top) and short (bottom) cables unterminated. Traces are offset two divisions and the photograph is a double exposure.....	2-6
3-1	Dimensions of 11A32.....	3-9

Tables

2-1	Functions And Where They Are Described.....	2-2
3-1	Electrical Characteristics.....	3-1
3-2	Environmental Characteristics.....	3-7
3-3	Physical Characteristics.....	3-8

Part 1

General Information

Technical Manuals

This Supplement to the User's Reference manuals is a standard accessory to the 11A32. An 11A32 Service manual is also available.

Contents of this Supplement

This Supplement contains the following three parts:

Part 1—GENERAL INFORMATION, describes mainframe to plug-in unit compatibility, explains how to install and remove the 11A32 from a mainframe, outlines any options available for the 11A32, and gives details about packaging for shipment.

Most 11A32 functions, and how they are operated, are described in the Operating Information section of the mainframe User's Reference manuals. Such functions are those that are common to all amplifier plug-in units. Examples of common functions are position, sensitivity, input impedance (where selectable), coupling, and bandwidth limit. Only those functions unique to the 11A32-11301/11302 combination are explained in the following parts.

Part 2—OPERATING THE 11A32 IN 11301 AND 11302 MAINFRAMES, explains how to operate those 11A32 functions not covered in the 11301 and 11302 User's Reference manual.

Part 3—SPECIFICATION, gives detailed specifications of all 11A32-mainframe oscilloscope combinations.

11A32 Service Manual

WARNING

The 11A32 Service manual is for use by qualified service personnel only. To avoid personal injury, do not perform any service other than that contained in the Operators manual unless you are qualified to do so. Refer to the Operators Safety Summary and Service Safety Summary before performing any service.

The 11A32 Service manual contains the following information:

Section 1—GENERAL INFORMATION.

Section 2—THEORY OF OPERATION.

Section 3—MAINTENANCE.

Section 4—CHECKS AND ADJUSTMENT.

Section 5—INSTRUMENT OPTIONS.

Section 6—REPLACEABLE ELECTRICAL PARTS.

Section 7—DIAGRAMS AND CIRCUIT BOARD ILLUSTRATIONS.

Section 8—REPLACEABLE MECHANICAL PARTS.

Plug-in to Mainframe Compatibility

The 11A32 is designed for use in the 11301, 11302, 11401, 11402, and future 11000-series plug-in mainframes. 11A32 bandwidth varies depending on host mainframe. Details about bandwidth are included in Part 3, Specification, of this subsection, and in the Tektronix Corporate Catalog. Refer to the Tektronix Corporate Catalog for complete compatibility information.

Initial Inspection

This instrument was inspected mechanically and electrically before shipment. It should be free of marks or scratches and should meet all electrical specifications. To confirm this, inspect the 11A32 for physical damage incurred in transit. Instrument performance may be verified by using the procedure given in Part 5, Incoming Inspection and Performance Verification, in the 11A32 User's Reference Supplement, Tektronix Part 070-5922-00. If you find damage or deficiency, contact your local Tektronix Field Office or representative.

Operating Temperature

The 11A32 can be operated where the ambient air temperature is between 0° and +50° C and can be stored in ambient temperatures from -40° to +75° C. After storage at temperatures outside the operating limits, allow the chassis to reach operating temperature limits before applying power.

Installing and Removing the 11A32



CAUTION

To avoid instrument damage set the mainframe ON/STANDBY switch to STANDBY before installing or removing the 11A32.

When installed in the 11301/11302 left or center plug-in compartment, the 11A32 will provide a conventional display.

When installed in the center or right plug-in compartment of the 11301/11302, the 11A32 will also provide the X (horizontal) part of an X-Y display, or provide a trigger signal for the mainframe time base.

To install the 11A32 in any 11000-series oscilloscope mainframe, set the mainframe ON/STANDBY switch to STANDBY. Align the grooves in the top and bottom of the 11A32 with the guides in the mainframe plug-in compartment, then insert the 11A32 into the mainframe until its front panel is flush with the front panel of the mainframe.

To remove the 11A32 from a mainframe, set the mainframe ON-STANDBY switch to STANDBY. Then pull the release latch (see Fig. 1-1) to disengage the unit from the mainframe, and pull the 11A32 straight out of the plug-in compartment.

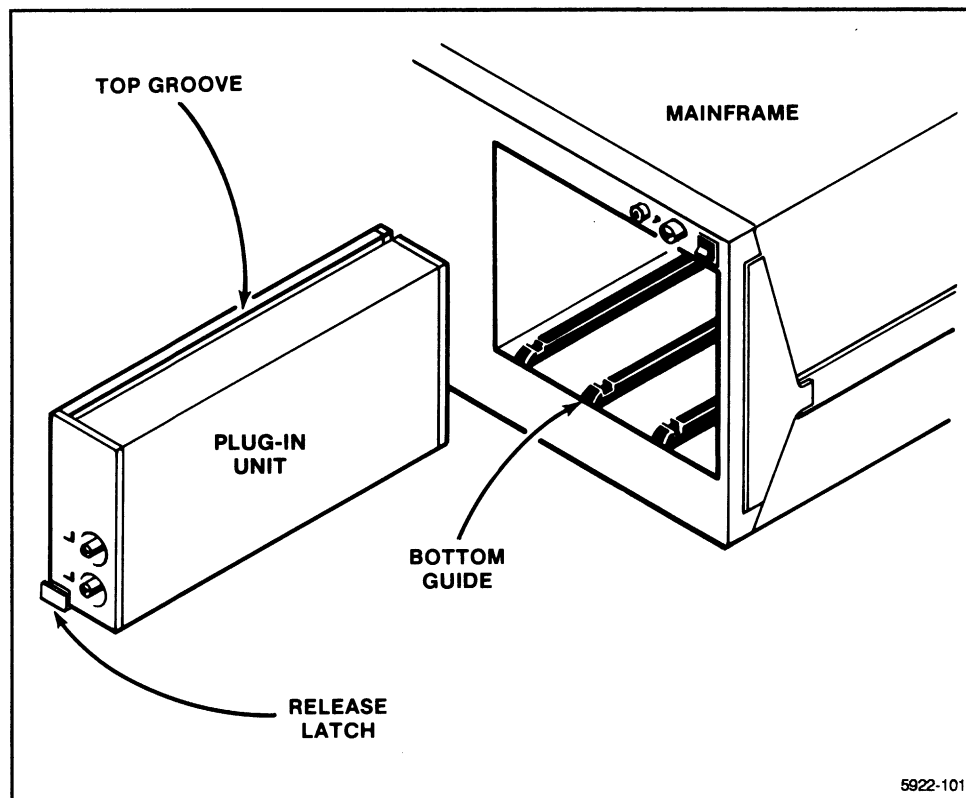

Figure 1-1. Installing a plug-in unit in a mainframe oscilloscope.

Instrument Options

Option 22 includes two P6134 probes.

Packaging for Shipment

If this instrument is to be shipped by commercial transportation, we recommend that it be packaged in the original manner. The original carton and packaging material can be saved and reused for this purpose.

NOTE

Package and ship plug-in units and mainframes separately.

If the 11A32 is to be shipped to a Tektronix Service Center for service or repair, attach a tag to the instrument. On the tag, include the following information:

- Name and address of the instrument owner;
- Name of a person at your firm who can be contacted about the instrument;
- Complete instrument type and serial number; and
- A description of the service required.

If the original package is not available or is not fit for use, package the 11A32 as follows:

1. Obtain a corrugated cardboard carton with inside dimensions at least six inches greater than the instrument dimensions. Use a carton with a test strength of at least 200 pounds.
2. Fully wrap the 11A32 with anti-static sheeting, or its equivalent, to protect the finish.
3. Cushion the 11A32 on all sides by tightly packing dunnage or urethane foam between the carton and the instrument. Allow three inches of packing on each side.
4. Seal the carton with shipping tape or with industrial staples.
5. Mark the address of the Tektronix Service Center and your return address on the carton in one or more prominent places.

Part 2

Operating the 11A32 in 11301 and 11302 Mainframes

Display On/Off

The 11A32 has only two front-panel controls—the display on/off buttons. Pressing a display on/off button will cause its channel, and signal, to be displayed or removed from the display (the function "toggles"). When a channel is displayed, its label (CH 1 or CH 2) will be lighted.

Selecting Coupling, HF Limit, and Impedance

To select the desired setting for Coupling, HF Limit, or Impedance, proceed as follows:

- 1a. If no trace is displayed, press any plug-in display on/off button to create a trace.
- 1b. If several traces are displayed, select a channel by touching the desired trace description at the top of the crt.
2. Press any VERTICAL button—OFFSET, SIZE, or POS. This button-press will cause the Control Menu to be displayed.
3. Touch the desired function's label. Successive touches will change its state.

Other Functions

Other 11A32 functions are controlled within the 11301 or 11302 mainframe, and their operation is described in detail in Section 2, Operating Information, of the 11301 and 11302 User's Reference manual. Table 2-1 shows where to find information about operating the 11A32.

TABLE 2-1
Functions And Where They Are Described

Function	Described Under Heading
Offset, Size (V/div)	Waveform Acquisition: Vertical Menu; or for X-Y Display: Horizontal Menu.
Display \pm Ch 1, \pm Ch 2	Waveform Acquisition: Vertical Menu.
Polarity	Waveform Acquisition: Waveform Menu.
Trigger Selection	Trigger Source Major Menu and Polarity

Position and Offset

The 11301 and 11302 oscilloscopes assign position control to the Left Control knob by pressing the VERTICAL POS button. The Vertical Position control moves the trace as a user convenience. For example, when displaying multiple channels it may be desirable to set ground references for each trace on separate graticule lines. Position is a screen-related function; its units are divisions.

The offset function, accessed by pressing the VERTICAL OFFSET button, subtracts a precision voltage from the input signal. Changing offset moves the trace just as does the position control. However, if the deflection factor is subsequently changed, the effect is different.

Changing the sensitivity will increase or decrease the size of the display around some screen level (e.g., two divisions above graticule center) set by the Position control. When using a sensitivity that makes the displayed waveform larger than the screen, the Offset control is used to bring the waveform area of interest to the screen location established by the Position control.

The Position control has a range of plus and minus four divisions from graticule center, but the Offset control has a range defined in volts. Offset can be as much as 1000 divisions at 1 mV/division. The Offset control range is one volt for all sensitivities from 1 mV to 99.5 mV/division, but increases to 10 volts for sensitivities from 100 mV to 995 mV/division. For sensitivities from 1 volt to 10 volts/division, Offset control range increases to 100 volts.

The 11A32 attempts to maintain the user-selected offset voltage even though the offset range changes due to a change in sensitivity. An offset voltage of less than one volt will be maintained as the sensitivity is changed over the entire range of 1 mV/division to 10 V/division. A selected offset of greater than one volt is beyond the offset range for the most sensitive settings and will be reset to one volt when the sensitivity is increased to any value between 99.5 mV and 1 mV/division.

HF Limit

Two four-pole (24 dB/octave) bandwidth limit (low-pass) filters are available for each 11A32 channel. The purpose of these filters is to reduce the amplitude of unwanted noise or interference occurring at frequencies above the frequency of the signal of interest. The user has a choice of cut-off (-3 dB) frequencies, either 20 MHz or 100 MHz, independently for each channel. The trigger, auxiliary trigger, and display signal bandwidths for a channel are always the same. The auxiliary trigger is the signal sent to the right plug-in compartment.

DC Circuit Loading

AC coupling capacitors are connected differently in the 11A52 and 11A71 than in the 11A32 and 11A34. Figure 2-1 shows this difference.

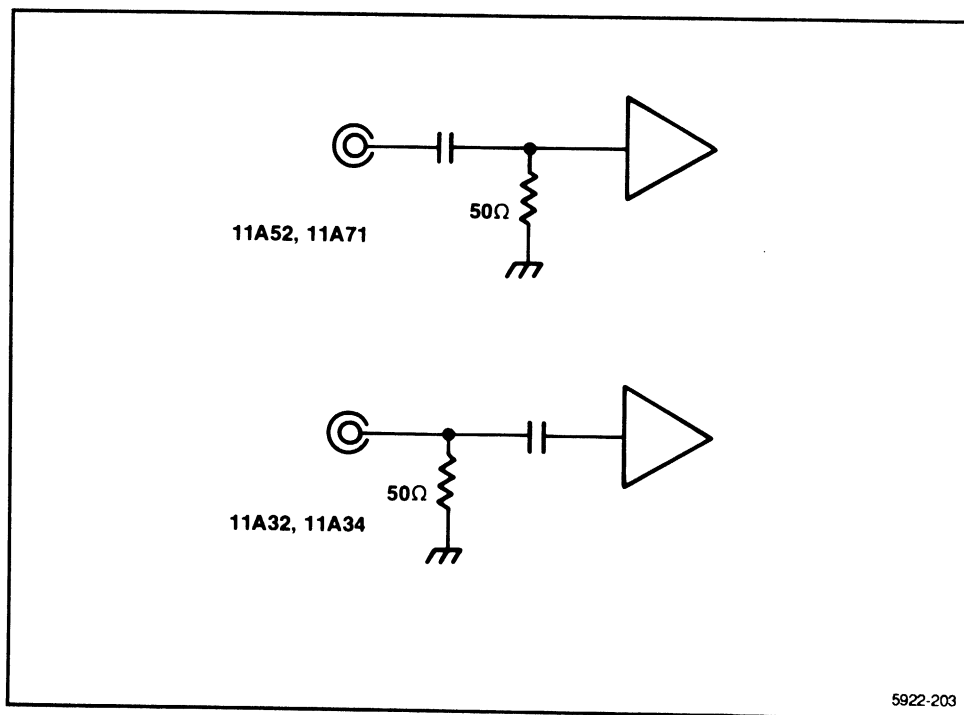

Figure 2-1. Location of AC coupling capacitors in plug-in amplifiers.

In the 11A52 and 11A71, the coupling capacitor isolates both the input termination and the amplifier from external dc voltages. However, the coupling capacitor in the 11A32 and 11A34 does not.

CAUTION

Always use caution when working with voltages in excess of 25 volts.

When 50 Ω Impedance mode is selected and input coupling is set to AC or DC, a 50 Ω termination resistance is connected directly from the 11A32 input connector to ground. Take care that the circuit connected to the 11A32 input will not be damaged by the 50 Ω load.

Switching from 1 M Ω to 50 Ω Impedance mode when more than 25 Vdc is present at the 11A32 input will exceed the peak input voltage specification and may damage the 11A32 input relay. A damaged relay could cause an error in calibration.

Adding and Subtracting Waveforms

NOTE

Before adding or subtracting waveforms, check that each channel's display is independently on screen.

The 11301 and 11302 allow the addition or subtraction of any two channels. Two channels within one plug-in unit may be added, or one channel may be added to a channel from another plug-in unit. A simple restriction applies. Each channel must be in its linear operating range. This is assured if each channel separately is within the screen area before addition or subtraction.

Those portions of a trace which are off screen will not be valid when brought back on screen using another channel's input signal or Offset control. This general restriction applies to any dual-channel oscilloscope.

Overdrive Recovery

Overdrive occurs when any 11A32 channel is driven out of its linear range of approximately ± 15 divisions.

The 11A32 has extraordinarily good overdrive recovery, and this feature may be used to greatly extend measurement resolution. For example, suppose a signal changes from -1.7 V to $+0.8$ V in 1 ns. The 11A32 could be used to determine if the signal stabilized immediately at $+0.8$ V or if perhaps had some small

aberration following the transition. By setting the 11A32 offset to +0.8 V and the sensitivity to 1 mV/division, aberrations of just 0.1% of the original transition will be 2.5 divisions in amplitude (0.1% of 2.5 V is 2.5 mV or 2.5 divisions at 1 mV/division).

Any amplifier will ultimately reach an equilibrium value after an input step (although its accuracy will determine how far that equilibrium value is from the correct value). The 11A32's ability to settle quickly to within a very small fraction of its equilibrium value is exceptional. The time it takes the 11A32 to settle to within a stated fraction of the equilibrium value is its overdrive recovery time.

Measuring the overdrive recovery time of an 11A32 takes some care and can lead to some surprising results. An interesting experiment is to use a very flat pulse generator, such as the Tektronix PG 506, to pulse the 11A32. Connect the generator's fast-rise output to the 11A32 input through a short (one foot or less) coaxial cable and select 50 Ω input impedance. Adjust the pulse amplitude to 1 volt. Set the 11A32 sensitivity to 1 mV/division. Each division now represents 0.1% of the input signal. Trigger the oscilloscope and observe the recovery of the 11A32 using 50 ns/division sweep rate. Now increase the cable length by about three feet (for example, use a 42-inch length of RG-58 cable, Tektronix part 012-0057-01) and observe the new waveform. See Figure 2-2.

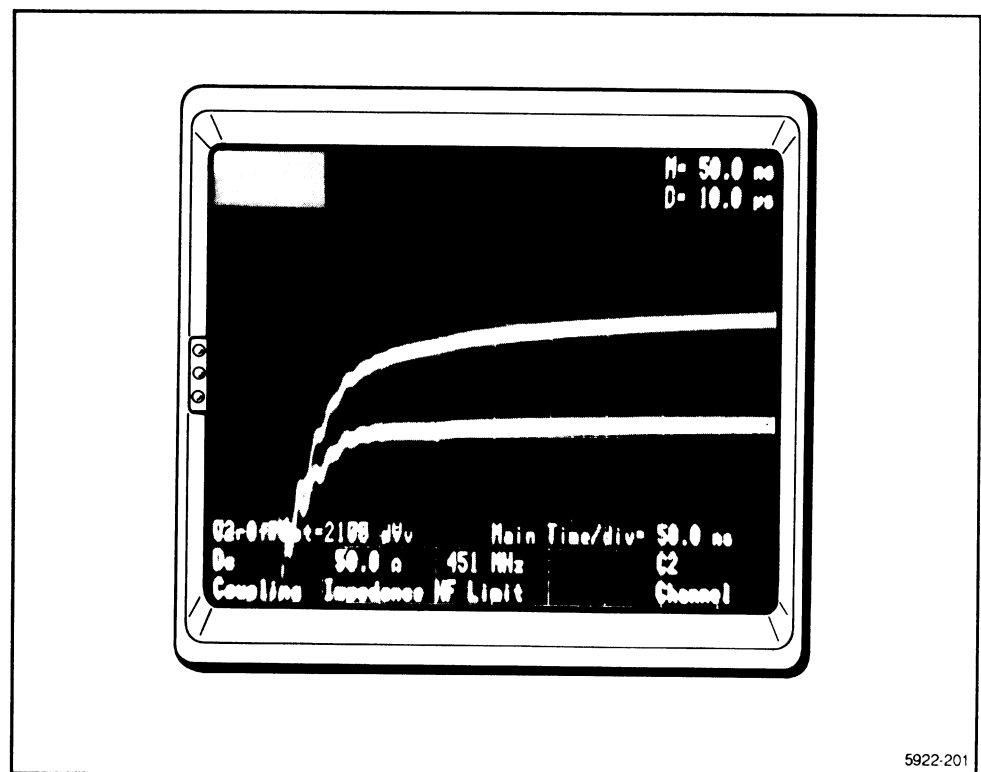

Figure 2-2. Overdrive recovery using long (top) and short (bottom) cables terminated in 50 Ω . Traces are offset two divisions and the photograph is a double exposure.

The waveform change is due to skin effect loss in the longer cable. What is surprising is that the skin effect loss persists for over 200 ns even though the total cable delay is only 5 ns. At 400 ns the loss is still 0.02%.

This experiment shows the importance of using a short cable to test overdrive recovery.

A second surprise is that skin effect loss disappears almost completely (after two cable delays) when one end is unterminated.

To observe this, use the short cable again, and select 1 M Ω input impedance on the 11A32. Insert a 2X attenuator between the cable and the pulse generator to improve the reverse termination and to provide the same amplitude signal as before. Observe the response and change cables again. Even at 0.1% per division the skin effect loss is hard to detect without the forward termination. The reason for this is that the skin effect loss is an increase in the effective series resistance of the cable. Without current, the cable develops no series voltage drop. See Figure 2-3.

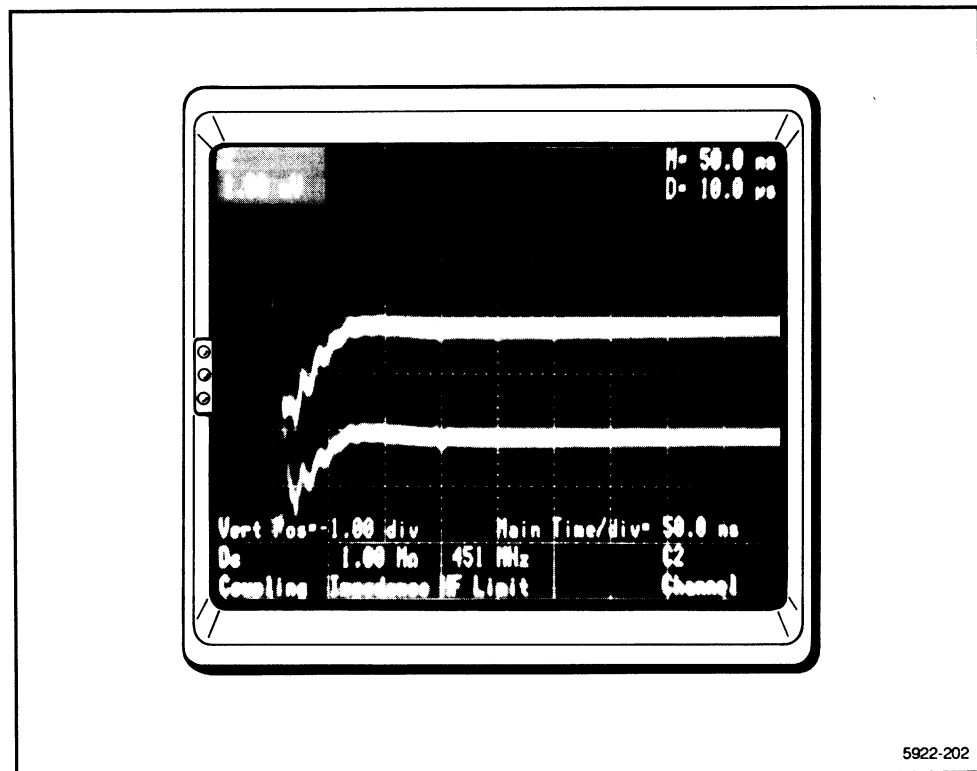

Figure 2-3. Overdrive recovery using long (top) and short (bottom) cables unterminated. Traces are offset two divisions and the photograph is a double exposure.

50Ω Overload

When the input impedance is set to 50Ω and the input voltage substantially exceeds 5 Vrms, the 11A32 will sense the overload, disconnect the 50Ω input termination, and connect the 1 MΩ termination. The Impedance menu will show 1 MΩ, and the mainframe will display the message: "Input channel N overload on LEFT/CENTER/RIGHT plugin," where N = 1 or 2.

To reset the input impedance to 50Ω, first correct the overload condition, then select 50Ω from the Impedance menu.

Active Probes

Using an active probe, such as the P6231, eliminates two options: Ac Coupling and 1 MΩ input impedance. Coupling options available when using such a probe are Off and Dc; the only Impedance available is 50Ω.

Probe ID

The Probe ID part of the Utility Menu is the means of selecting how the 11301 or 11302 responds to an ID button-push of recommended probes. All, or some combination of the following operations may be set to start in response to probe ID buttons. To display the Utility Menu, press the front-panel UTILITY button. For details, see the Probe ID part of the Waveform Acquisition subsection in the 11301 and 11302 User's Reference manual.

Pressing the probe ID button can initiate one or more of the following operations:

1. **Present a new display, or if that channel is already displayed, "select" the existing trace.** Pressing the ID button of a probe connected to an undisplayed left or center compartment channel will cause that channel to be displayed, unless doing so would exceed the maximum number or traces. Unlike the 11A32 display on/off button, pressing the probe ID button a second time will not remove the display. Probe ID button-presses for displayed channels will do two things: a) select the trace(s) using this channel, and b) momentarily brighten all traces using this channel.
2. **Stored settings can be sequentially recalled.** Pressing the probe ID button can cause a sequential recall of stored settings. The stored settings feature must be enabled using the Probe ID Utility menu. Settings must be stored as explained under STORE/RECALL Major Menu in the 11301 and 11302 User's Reference manual.

3. **The mainframe can "Autoset" to accommodate the input signal introduced by the probe.** The Autoset feature can be enabled or disabled using the Probe ID Utility menu. Autoset is the automatic setup of vertical deflection factor, triggering, and sweep speed to produce a meaningful display, e.g., two to five divisions of vertical deflection and two to five repetitions of the input signal. For more information, refer to Autoset in the 11301 and 11302 User's Reference manual.
4. **The mainframe can automatically measure the selected trace.** Automatic measurements of the selected trace can be initiated by pressing a probe ID button. The Automatic Measurements feature can be enabled or disabled using the Probe ID Utility menu. Such measurements are peak-to-peak, maximum, middle, and minimum voltages; frequency, period, pulse width, and duty cycle. For full information about automatic measurements, see Measure in the 11301 and 11302 User's Reference manual.
5. **An interrupt to the GPIB and RS-232-C can be generated.** Pressing a probe ID button will cause the mainframe to produce an SRQ to the GPIB and RS-232-C. For more information, refer to the GPIB/RS-232-C part of the 11301 and 11302 User's Reference manual.

Front-Panel Error Messages

- Message:** Internal DAC overflow on channel N of LEFT, CENTER, or RIGHT plug-in unit, where N = 1 or 2.
- Cause:** Some plug-in unit detected that a requested setting overflowed an internal DAC. Such overflow usually indicates defective hardware. In this situation, the plug-in unit sets the DAC to the limit nearer the requested setting.
- Message:** Bad Level 2 probe checksum on channel N of LEFT, CENTER, or RIGHT plug-in unit, where N = 1 or 2.
- Cause:** Some plug-in unit detected that a Level 2 TEKPROBE had failed or been improperly connected.

GPIB and RS-232-C Commands and Syntax

The following commands set parameters of a specified channel.

Header	Link	Argument		
CH<L1, L2, C1, C2, R1 or R2>	COUPLING:	AC DC OFF		
	OFFSET: ¹	<NRx>		
	Volts/div	Offset Range	Resolution via RS-232-C, GPIB, or Numeric Entry	Step Size via front-panel Control knob
	1 mV to 99.5 mV 100 mV to 995 mV 1 V to 10 V	±1 V ±10 V ±100 V	25E-6 250E-6 2.5E-3	{ Coarse: 0.25 div. Fine: 0.025 div.
	BWHI:	<NRx> ≤24E6 >24E6 to ≤120E6 >120E6	HF Limit 20E6 100E6 300E6, 11301 350E6, 11302	
	IMPEDANCE:	<NRx> <1E3 ≥1E3	Impedance 50 1E6	
	SENSITIVITY: ¹	Sensitivity 1E-3 to 1.99E-3 2E-3 to 4.98E-3 5E-3 to 9.95E-3 10E-3 to 19.9E-3 20E-3 to 49.8E-3 50E-3 to 99.5E-3 100E-3 to 199E-3 200E-3 to 498E-3 500E-3 to 995E-3 1 to 1.99 2 to 4.98 5 to 10	Resolution (step size) 10E-6 20E-6 50E-6 100E-6 200E-6 500E-6 1E-3 2E-3 5E-3 10E-3 20E-3 50E-3	
	UNITS:	<qstring> (query only) The 11A32 answers a Units query with a units status message, which indicates the units of conversion of a probe connected to its Ch N input.		

¹ The numbers listed are those available at the input connectors. Connecting an attenuating probe will change the value by the probe attenuating factor (e.g., a 10X probe will change the value ±10 to ±100).

Header	Link	Argument
CH<L1,L2,C1 C2,R1 or R2> (cont)	PROBE:	<qstring> (query only) This query-only link returns a quoted string indicating what type of probe is connected to the input. If a Level 1 TEKPROBE is connected, the query response is "Level 1." If a Level 2 TEKPROBE is connected, the query response is "Level 2/<probe_type>/<serial_number>." When neither Level 1 nor Level 2 TEKPROBE is connected, the query response is "NONE."

Legend:

CH<L1, L2, C1, C2, R1 or R2>	L, C, and R mean Left, Center, and Right plug-in compartments; 1 and 2 mean Channel 1 and Channel 2, respectively.
COUPLING	Sets the specified channel input coupling.
OFFSET	Sets the specified channel offset.
BWHI	Sets the HF Limit (bandwidth) of the specified channel.
NRx	Numeric representation.
IMPEDANCE	Sets the input impedance of the specified channel.
SENSITIVITY	Sets the deflection factor of the specified channel. Sensitivity is a channel-specific command which does not apply to compound waveforms.
qstring	Quoted string data.

Part 3

Specification

Performance Conditions

The specifications that follow apply when the instrument is in the condition of Enhanced Accuracy. Enhanced Accuracy is obtained by performing an Enhanced Calibration in the specific host mainframe after the system has reached thermal equilibrium, which requires 20 minutes warmup. Enhanced Accuracy is indicated on the crt display and remains in effect as long as the mainframe internal temperature change is less than 5° C from the temperature at which the calibration was performed. When the 5° C change does occur the accuracy condition becomes Not-Enhanced. In the Not-Enhanced condition those Characteristics that are temperature sensitive may not remain within the limits of these specifications.

TABLE 3-1
Electrical Characteristics

Characteristic	Performance Requirement
DISPLAY	
DEFLECTION FACTOR (Sensitivity)	
Calibrated Range	1 mV to 10 V/div.

Enhanced DC Accuracy¹, either polarity, any HF Limit of 11A32 in 11301/11302 Mainframes, with on-screen cursors.

Without Probes

Volts/Div	ΔV DC Acc.	DC Balance	DC Offset Acc.
1 mV to 99.5 mV	$\pm(1.0\% + 0.04\text{div})$	$\pm(1\text{mV} + 0.13\text{div})$	$\pm(0.20\% + 0.5\text{mV})$
100 mV to 995 mV	$\pm(1.0\% + 0.04\text{div})$	$\pm(10\text{mV} + 0.13\text{div})$	$\pm(0.25\% + 5\text{mV})$
1 V to 10 V	$\pm(1.0\% + 0.04\text{div})$	$\pm(100\text{mV} + 0.13\text{div})$	$\pm(0.25\% + 50\text{mV})$

With P6134 Probe calibrated from 11301/11302 Calibrator output

Volts/Div	ΔV DC Acc.	DC Balance	DC Offset Acc.
10 mV to 995 mV	$\pm(1.0\% + 0.04\text{div})$	$\pm(12\text{mV} + 0.13\text{div})$	$\pm(0.25\% + 5\text{mV})$
1 V to 9.95 V	$\pm(1.0\% + 0.04\text{div})$	$\pm(120\text{mV} + 0.13\text{div})$	$\pm(0.25\% + 50\text{mV})$
10 V to 100 V	$\pm(1.0\% + 0.04\text{div})$	$\pm(1.2\text{V} + 0.13\text{div})$	$\pm(0.25\% + 0.5\text{V})$
Probe tip TC term	100 ppm/°C	na	na

¹For absolute dc accuracy of single-point measurements using Offset, add the DC Offset Accuracy, DC Balance and ΔV DC Accuracy terms. Apply the ΔV DC Accuracy only to the difference between the Vertical Position setting and the measurement point.

TABLE 3-1 (cont)
Electrical Characteristics

Characteristic	Performance Requirement
----------------	-------------------------

DISPLAY (cont)

DEFLECTION FACTOR (Sensitivity), cont.

Enhanced DC Accuracy¹, either polarity, any HF Limit, of 11A32 in 11301/11302 Mainframes

With P6231 Probe calibrated from 11301/11302 Calibrator output

Volts/Div	ΔV DC Acc.	DC Balance	DC Offset Acc.
10 mV to 995 mV	$\pm(1.1\% + 0.04\text{div})$	$\pm(10\text{mV} + 0.13\text{div})$	$\pm(0.20\% + 2\text{mV})$
≥ 1 V	$\pm(1.1\% + 0.04\text{div})$	$\pm(100\text{mV} + 0.13\text{div})$	$\pm(0.20\% + 2\text{mV})$
Probe Tip TC term	100 ppm/ $^{\circ}$ C		

¹For absolute dc accuracy of single-point measurements using Offset, add the DC Offset Accuracy, DC Balance and ΔV DC Accuracy terms. Apply the ΔV DC Accuracy only to the difference between the Vertical Position setting and the measurement point.

TABLE 3-1 (cont)
Electrical Characteristics

Characteristic	Performance Requirement
DISPLAY (cont)	
DEFLECTION FACTOR (Sensitivity), cont.	
Coarse Resolution	1, 2, 5 sequence.
<p>Fine Resolution depends on Deflection Factor, as follows:</p> <p>Rotating the Fine control one increment will change the Deflection Factor by 1% of the next more-sensitive Coarse setting.</p> <p>For example, with deflection factor set to 198 mV, rotating the Fine control counterclockwise will cause this sequence of sensitivities: 199 mV, 200 mV, 202 mV, etc. Rotating the Fine control clockwise from 204 mV/div will cause the reverse sequence (202 mV, 200 mV, 199 mV, etc.).</p>	
OFFSET	
Accuracy	See Deflection Factor Accuracy, which precedes this characteristic.
Range, Resolution depend on Deflection Factor, as follows: between 1 mV and 99.5 mV/div.	±1 V. Coarse and fine resolution are 0.25 div. (250 μV) and 0.025 div. (25 μV), respectively.
between 0.1 V and 0.995 V/div.	±10 V. Coarse and fine resolution are 0.25 div. (2.5 mV) and 0.025 div. (250 μV), respectively.
between 1 V and 10.0 V/div.	±100 V. Coarse and fine resolution are 0.25 div (25 mV) and 0.025 div. (2.5 mV), respectively.

TABLE 3-1 (cont)
Electrical Characteristics

Characteristic	Performance Requirement	
DISPLAY (cont)		
FREQUENCY RESPONSE		
High Frequency Limit (-3dB point) of Display, Auxiliary, & Trig signals, Zin=50Ω and Calculated Rise Time	Type of Mainframe	
	11301	11302
Volts/Division	11301	11302
≥10 mV	300 MHz 1.2 ns	350 MHz 1.0 ns
5 mV – 9.95 mV	300 MHz 1.2 ns	300 MHz 1.2 ns
2 mV – 4.98 mV	250 MHz 1.4 ns	250 MHz 1.4 ns
1 mV – 1.99 mV	200 MHz 1.8 ns	200 MHz 1.8 ns
High Frequency -3dB point		
100 MHz Limit	100 MHz ±30%.	
20 MHz Limit	20 MHz ±30%.	
Low Frequency -3 dB point, ac coupled Display, Trig, and Auxiliary signals	10 Hz maximum.	

TABLE 3-1 (cont)
Electrical Characteristics

Characteristic	Performance Requirement
INPUT CHARACTERISTICS	
Maximum Input Voltage, DC Coupled, $Z = 1\text{ M}\Omega$	$\pm 500\text{ V}$ (dc+peak ac). Derate at 20 dB per decade from 1 MHz to 5.0 V at 100 MHz.
Maximum Input Voltage, AC Coupled, $Z = 1\text{ M}\Omega$	$\pm 500\text{ V}$ (dc+peak ac). Derate at 20 dB per decade from 1 MHz to 5.0 V at 100 MHz.
Maximum Input Voltage, AC or DC Coupled, $Z = 50\Omega$	5 Vrms (0.5 W) or 0.5 watt-second pulses not exceeding 25 V peak.
Input Disconnect Threshold	5 Vrms minimum.
Power-Down Input Impedance	1 M Ω .
Input Impedance (50 Ω , dc coupled)	50 Ω within 1/2%; VSWR less than 1.2:1 for V/div < 1 V; VSWR less than 1.3:1 for V/div from 1 V to 10 V, dc to 350 MHz.
Input Impedance (1 M Ω , dc coupled)	1 M Ω within 1/2% in parallel with approximately 15 pF.
Input Impedance (1 M Ω , ac coupled)	1 M Ω within 1/2%, in series with 0.022 μF and in parallel with approximately 15 pF.
Input Bias Current	Less than 100 pA.

TABLE 3-1 (cont)
Electrical Characteristics

Characteristic	Performance Requirement
MISCELLANEOUS	
Overdrive Recovery Time	
1 mV to 9.95 mV/div	<50 ns to 0.3% + 0.2 div for Vin of <2.0 V.
100 mV to 995 mV/div	<50 ns to 1.0% for Vin of <20 V.
1.0 V to 10.0 V/div	<50 ns to 1.0% for Vin of <200 V.
Typical Noise	
1.0 mV to 1.99 mV/div	0.12 div, rms.
2.0 mV to 4.98 mV/div	0.06 div, rms.
5.0 mV to 9.95 mV/div	0.025 div, rms.
10.0 mV to 99.5 mV/div	0.014 div, rms.
100 mV to 995 mV/div	0.014 div, rms.
1.0 V to 10.0 V/div	0.014 div, rms.
DC Drift with Temperature	200 μ V/°C, or less, at any sensitivity. ¹
Channel Isolation	At least 50:1 display ratio ² , dc - 400 MHz.
Common Mode Rejection Ratio	At least 20:1, dc to 50 MHz, 10-div reference signal on each input.
Probe Compatibility	The 11A32 is compatible with Level 1 and Level 2 TEKPROBES. ³

¹Dc drift can be calibrated out by invoking a calibration (Enhanced Accuracy) at any specific operating temperature.

$$^2\text{Display ratio} = \frac{\text{Amplitude (div)} \times \text{V/div (driven channel)}}{\text{Error amplitude (div)} \times \text{V/div (undriven channel)}}$$

³TEKPROBE is Tektronix' name for the interface used with probes designed for the 11000-series of oscilloscopes and plug-in units. TEKPROBES have output connectors with one or more spring loaded coding pins. Two categories of TEKPROBES are:

Level 1

A level 1 probe, which uses analog encoding to indicate the probe's scale factor to the plug-in unit.

Level 2

A level 2 probe, which uses an EEPROM to store data about the probe's transfer units, scale factor, and output voltage scale factor. Such data are serially encoded, then stored in the EEPROM. The probe data is intended to be read once at instrument power-up or when the probe is first connected to a plug-in unit (that is, at probe power-up).

TABLE 3-2
Environmental Characteristics

Characteristic	Information
Ambient Temperature (external to main frame)	
Operating within specs.	0° to 50° C., mainframe ambient.
Nonoperating	-40° to +75° C.
Humidity, Operating and Nonoperating	Five days, per MIL-T-28800C. Type III, class 5 as described in 3.9.2.2 and 4.5.5.1.2.2.
Altitude	
Operating	To 4,570 m (15,000 ft.).
Nonoperating	To 15,200 m (50,000 ft.).
Vibration	
Operating, installed on Flexible Extender	MIL-T-28800C, Sec. 4.5.5.3.1, type III, class 5.
Shock, Nonoperating (not installed in mainframe)	MIL-T-28800C, Sec. 4.5.5.4.1, type III, class 5.
Bench Handling (operating and nonoperating)	MIL-T-28800C, Sec. 4.5.5.4.3, type III, class 5.
Packaged Product Vibration and Shock	
Vibration and Bounce of Packaged Product	Meets ASTM D999-75, Method A (NSTA Project 1A-B-1).
Drop of Packaged Product	Meets ASTM D775-61, Paragraph 5 (NSTA Project 1A-B-2).
Electromagnetic Compatibility	MIL. STD. 461B. FCC Part 15, Subpart J, Class A. VDE 0871/6.78, Class B.

Table 3-3
Physical Characteristics

Characteristic	Information
Weight (max)	1 lb. 14 oz. (851 grams)
Weight of Packaged Product (max)	4 lb. 12 oz. (2.2 kg)
Dimensions (max)	Refer to Figure 3-1.

Recommended Probes

Tektronix recommends these probes for use with the 11A32:

P6134 Subminiature 10X Passive Probe with ID. With 1 M Ω inputs, the P6134's input impedance is 10 M Ω in parallel with 10.5 pF. The P6134 is a Level 1 probe.

P6231 Low Impedance Subminiature 10X Active Probe. The P6231 has a bandwidth of 1.5 GHz, input impedance of 450 Ω , and dc offset of ± 5 V controlled by the 11A32. The P6231 is a Level 2 probe.

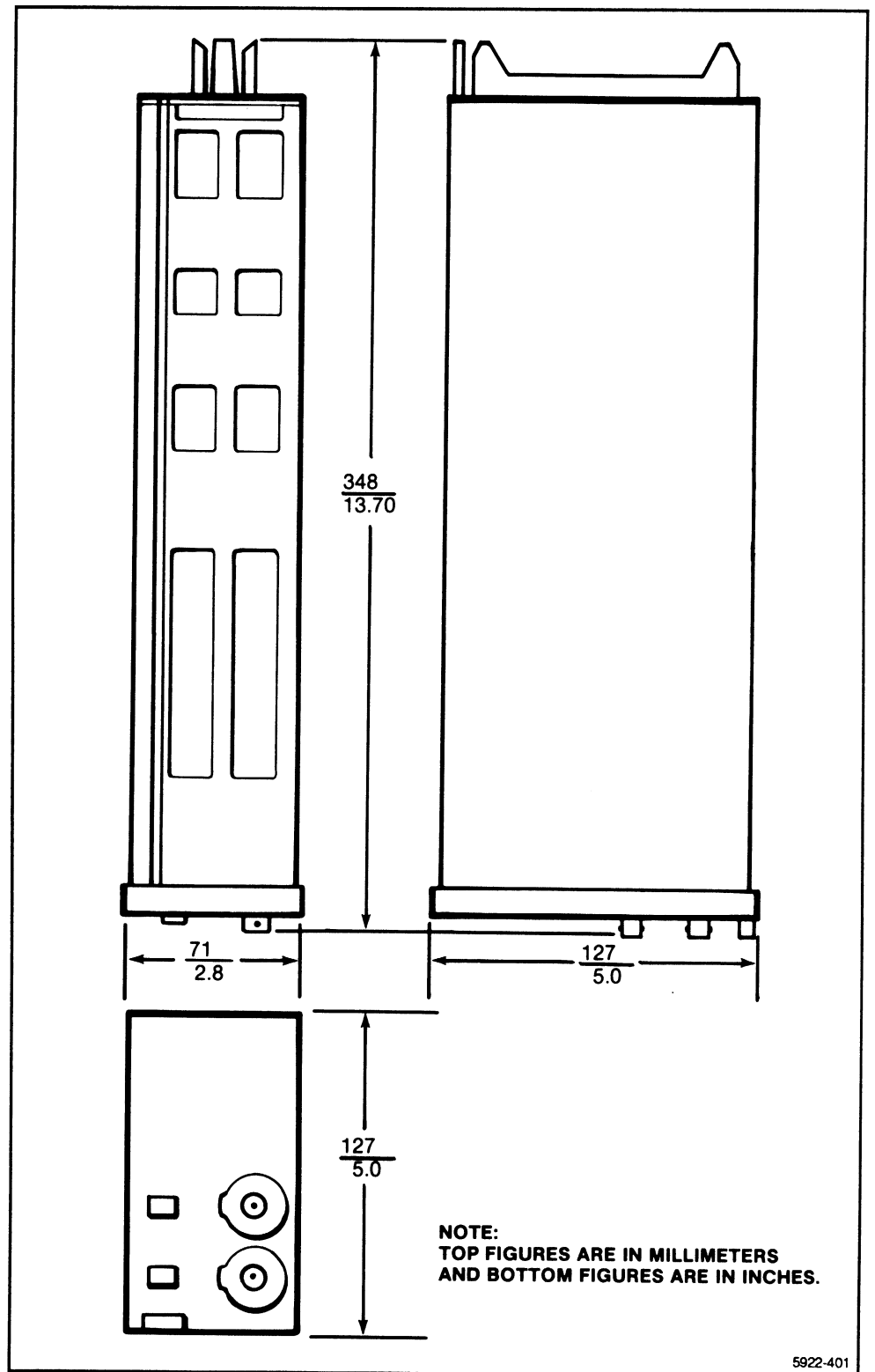
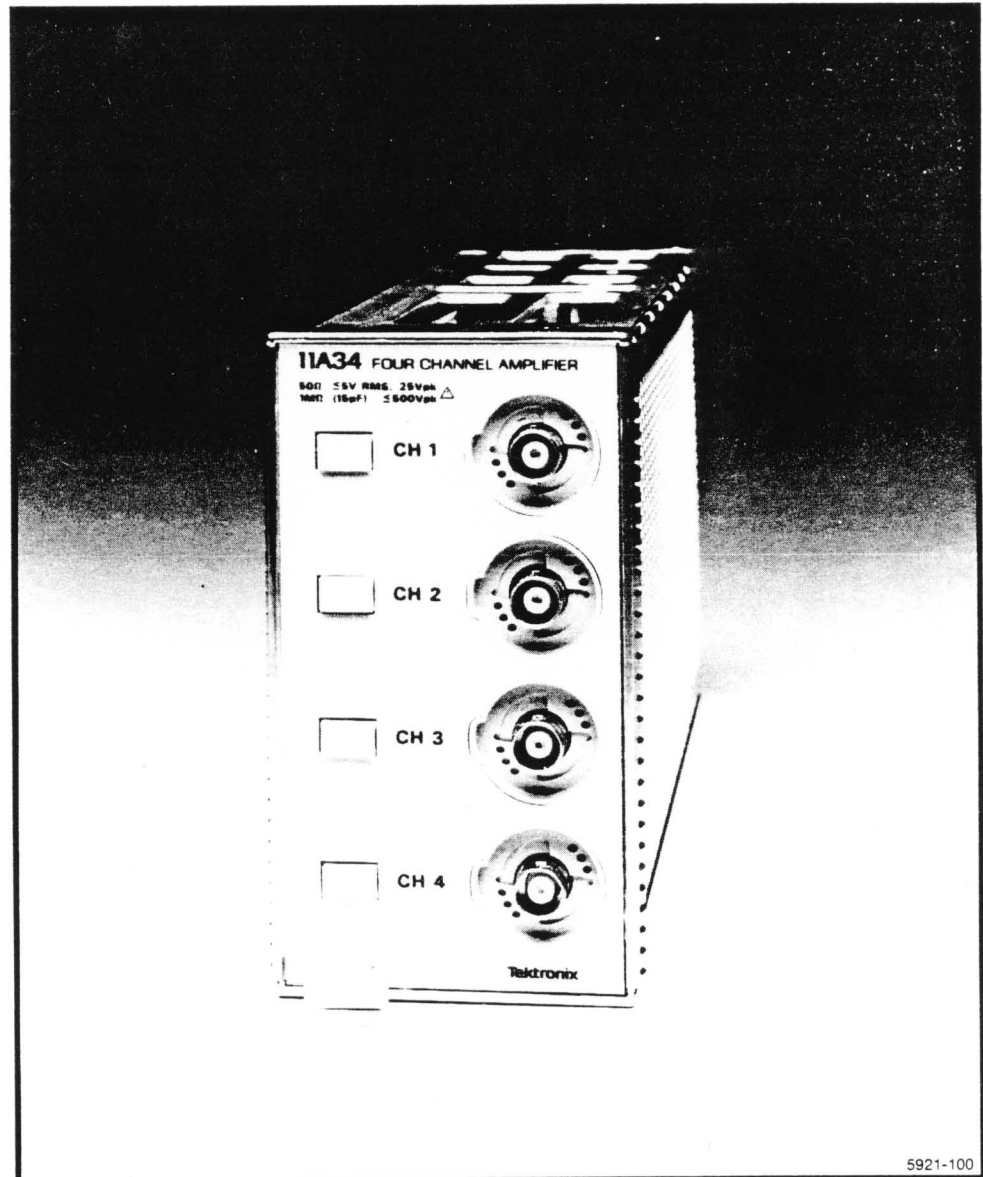

Figure 3-1. Dimensions of 11A32.

Appendix A—Glossary

Deflection factor	The ratio of input signal to response in the 11000 system. The reciprocal of sensitivity.
Display on/off button	The front-panel, plug-in button that designates a channel for display, or removes a channel from the display.
Mainframe	Any 11000-series oscilloscope exclusive of plug-in units.
Offset	A control that allows the user to subtract a precision voltage from the input signal to vary the position of the displayed signal.
ON/STANDBY	The front-panel power control on 11000-series mainframes. When set to ON, applies operating power to all circuits. When set to STANDBY, the mainframe dc power supply supplies power to the counter-timer crystal oven (Option 1T).
Overdrive	A condition in which amplifiers are driven into a non-linear operating range. Typically many divisions off screen.
Overload	The condition existing when a potentially damaging voltage is applied to the input connector.
Toggle	To switch alternately between two functions (e.g., on and off).

11A34 Four Channel Amplifier



11A34 Features and Functions

Features

- Dual trace
- Up to 250 MHz bandwidth (in 11302)
- Calibrated sensitivities from 1 mV to 10 V/division
- 50 Ω or 1 M Ω input impedance
- High-resolution, calibrated DC offset (0.25 division/increment, coarse; 0.025 division/increment, fine)
- Fast overdrive recovery

Functions

Signals applied to the CH 1, CH 2, CH 3 and CH 4 input connectors can be displayed or removed from the display by pressing the display on/off buttons adjacent to the input connectors.

All other 11A34 functions are controlled through the host mainframe. Such mainframe-controlled functions are:

- Sensitivity, Coarse and Fine, over a range of 1 mV to 10 V/division.
- Vertical Offset.
- Coupling: Ac, Dc, or Off.
- Impedance (input termination): 50 Ω or 1 M Ω .
- HF Limit: 100 MHz or 20 MHz.
- Display Polarity: normal or inverted.
- Trigger Polarity: normal or inverted.
- Combination of Display Channels: see Operating Information section of mainframe User's Reference manual.
- Combination of Trigger Channels: same as Display Channels; see Operating Information section of mainframe User's Reference manual.

Contents

Part 1—General Information	
Technical Manuals.....	1-1
Contents of this Supplement.....	1-1
11A34 Service Manual.....	1-2
Plug-in to Mainframe Compatibility.....	1-2
Initial Inspection.....	1-2
Operating Temperature.....	1-3
Installing and Removing the 11A34.....	1-3
Instrument Options.....	1-4
Packaging for Shipment.....	1-5
Part 2—Operating the 11A34 in 11301 and 11302 Mainframes	
Display On/Off.....	2-1
Selecting Coupling, HF Limit, and Impedance.....	2-1
Other Functions.....	2-2
Position and Offset.....	2-2
HF Limit.....	2-3
DC Circuit Loading.....	2-3
Adding and Subtracting Waveforms.....	2-4
Overdrive Recovery.....	2-4
50Ω Overload.....	2-7
Active Probes.....	2-7
Probe ID.....	2-7
Front-Panel Error Messages.....	2-8
GPIB and RS-232-C Commands and Syntax.....	2-9
Part 3—Specification	
Performance Conditions.....	3-1
Electrical Characteristics.....	3-1
Environmental Characteristics.....	3-7
Physical Characteristics.....	3-8
Recommended Probes.....	3-8
Appendix A—Glossary.....	A-1

Illustrations

1-1	Installing a plug-in unit in a mainframe oscilloscope.....	1-4
2-1	Location of AC coupling capacitors in plug-in amplifiers.....	2-3
2-2	Overdrive recovery using long (top) and short (bottom) cables terminated in 50Ω. Traces are offset two divisions and the photograph is a double exposure.....	2-5
2-3	Overdrive recovery using long (top) and short (bottom) cables unterminated. Traces are offset two divisions and the photograph is a double exposure.....	2-6
3-1	Dimensions of 11A34.....	3-9

Tables

2-1	Functions And Where They Are Described.....	2-2
3-1	Electrical Characteristics.....	3-1
3-2	Environmental Characteristics.....	3-7
3-3	Physical Characteristics.....	3-8

Part 1

General Information

Technical Manuals

This Supplement to the User's Reference manuals is a standard accessory to the 11A34. An 11A34 Service manual is also available.

Contents of this Supplement

This Supplement contains the following three parts:

Part 1—GENERAL INFORMATION, describes mainframe to plug-in unit compatibility, explains how to install and remove the 11A34 from a mainframe, outlines any options available for the 11A34, and gives details about packaging for shipment.

Most 11A34 functions, and how they are operated, are described in the Operating Information section of the mainframe User's Reference manuals. Such functions are those that are common to all amplifier plug-in units. Examples of common functions are position, sensitivity, input impedance (where selectable), coupling, and bandwidth limit. Only those functions unique to the 11A34-11301/11302 combination are explained in the following parts.

Part 2—OPERATING THE 11A34 IN 11301 AND 11302 MAINFRAMES, explains how to operate those 11A34 functions not covered in the 11301 and 11302 User's Reference manual.

Part 3—SPECIFICATION, gives detailed specifications of all 11A34-mainframe oscilloscope combinations.

11A34 Service Manual

WARNING

The 11A34 Service manual is for use by qualified service personnel only. To avoid personal injury, do not perform any service other than that contained in the Operators manual unless you are qualified to do so. Refer to the Operators Safety Summary and Service Safety Summary before performing any service.

The 11A34 Service manual contains the following information:

Section 1—GENERAL INFORMATION.

Section 2—THEORY OF OPERATION.

Section 3—MAINTENANCE.

Section 4—CHECKS AND ADJUSTMENT.

Section 5—INSTRUMENT OPTIONS.

Section 6—REPLACEABLE ELECTRICAL PARTS.

Section 7—DIAGRAMS AND CIRCUIT BOARD ILLUSTRATIONS.

Section 8—REPLACEABLE MECHANICAL PARTS.

Plug-in to Mainframe Compatibility

The 11A34 is designed for use in the 11301, 11302, 11401, 11402, and future 11000-series plug-in mainframes. 11A34 bandwidth varies depending on host mainframe. Details about bandwidth are included in Part 3, Specification, of this subsection, and in the Tektronix Corporate Catalog. Refer to the Tektronix Corporate Catalog for complete compatibility information.

Initial Inspection

This instrument was inspected mechanically and electrically before shipment. It should be free of marks or scratches and should meet all electrical specifications. To confirm this, inspect the 11A34 for physical damage incurred in transit. Instrument performance may be verified by using the procedure given in Part 5, Incoming Inspection and Performance Verification, in the 11A34 User's Reference Supplement, Tektronix Part 070-5921-00. If you find damage or deficiency, contact your local Tektronix Field Office or representative.

Operating Temperature

The 11A34 can be operated where the ambient air temperature is between 0° and +50° C and can be stored in ambient temperatures from -40° to +75° C. After storage at temperatures outside the operating limits, allow the chassis to reach operating temperature limits before applying power.

Installing and Removing the 11A34



To avoid instrument damage set the mainframe ON/STANDBY switch to STANDBY before installing or removing the 11A34.

When installed in the 11301/11302 left or center plug-in compartment, the 11A34 will provide a conventional display.

When installed in the center or right plug-in compartment of the 11301/11302, the 11A34 will also provide the X (horizontal) part of an X-Y display, or provide a trigger signal for the mainframe time base.

To install the 11A34 in any 11000-series oscilloscope mainframe, set the mainframe ON/STANDBY switch to STANDBY. Align the grooves in the top and bottom of the 11A34 with the guides in the mainframe plug-in compartment, then insert the 11A34 into the mainframe until its front panel is flush with the front panel of the mainframe.

To remove the 11A34 from a mainframe, set the mainframe ON-STANDBY switch to STANDBY. Then pull the release latch (see Fig. 1-1) to disengage the unit from the mainframe, and pull the 11A34 straight out of the plug-in compartment.

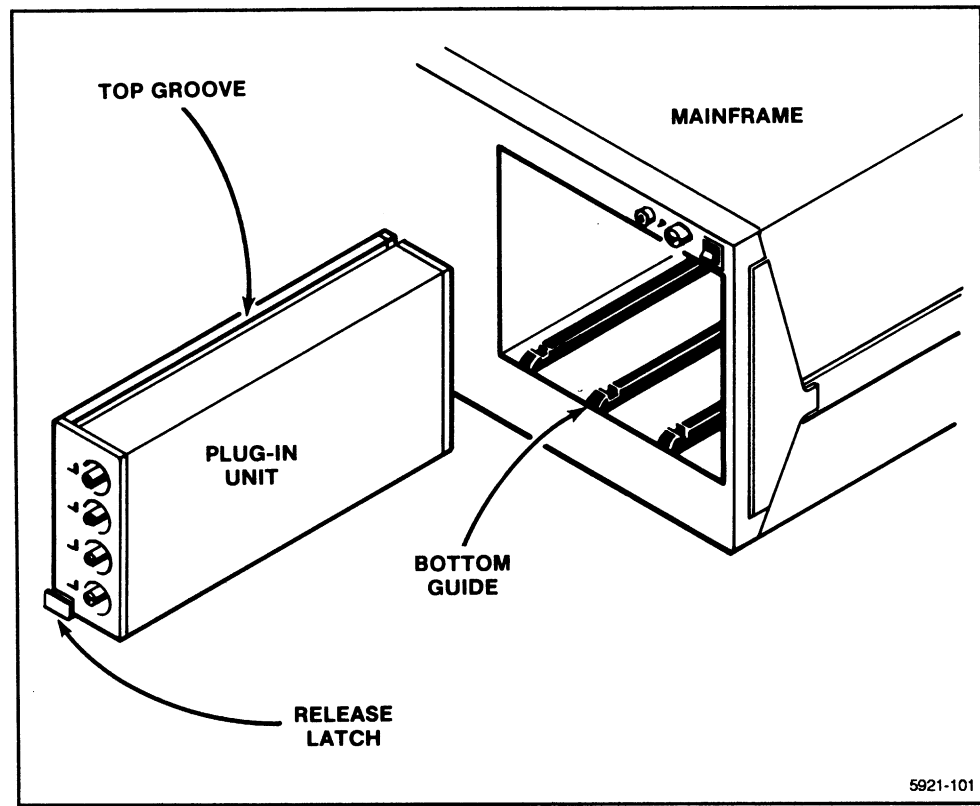

Figure 1-1. Installing a plug-in unit in a mainframe oscilloscope.

Instrument Options

Option 23 includes four P6134 probes.

Packaging for Shipment

If this instrument is to be shipped by commercial transportation, we recommend that it be packaged in the original manner. The original carton and packaging material can be saved and reused for this purpose.

NOTE

Package and ship plug-in units and mainframes separately.

If the 11A34 is to be shipped to a Tektronix Service Center for service or repair, attach a tag to the instrument. On the tag, include the following information:

- Name and address of the instrument owner;
- Name of a person at your firm who can be contacted about the instrument;
- Complete instrument type and serial number; and
- A description of the service required.

If the original package is not available or is not fit for use, package the 11A34 as follows:

1. Obtain a corrugated cardboard carton with inside dimensions at least six inches greater than the instrument dimensions. Use a carton with a test strength of at least 200 pounds.
2. Fully wrap the 11A34 with anti-static sheeting, or its equivalent, to protect the finish.
3. Cushion the 11A34 on all sides by tightly packing dunnage or urethane foam between the carton and the instrument. Allow three inches of packing on each side.
4. Seal the carton with shipping tape or with industrial staples.
5. Mark the address of the Tektronix Service Center and your return address on the carton in one or more prominent places.

Part 2

Operating the 11A34 in 11301 and 11302 Mainframes

Display On/Off

The 11A34 has only four front-panel controls—the display on/off buttons. Pressing a display on/off button will cause its channel, and signal, to be displayed or removed from the display (the function "toggles"). When a channel is displayed, its label (CH 1, CH 2, CH 3, or CH 4) will be lighted.

Selecting Coupling, HF Limit, and Impedance

To select the desired setting for Coupling, HF Limit, or Impedance, proceed as follows:

- 1a. If no trace is displayed, press any plug-in display on/off button to create a trace.
- 1b. If several traces are displayed, select a channel by touching the desired trace description at the top of the crt.
2. Press any VERTICAL button—OFFSET, SIZE, or POS. This button-press will cause the Control Menu to be displayed.
3. Touch the desired function's label. Successive touches will change its state.

Other Functions

Other 11A34 functions are controlled within the 11301 or 11302 mainframe, and their operation is described in detail in Section 2, Operating Information, of the 11301 and 11302 User's Reference manual. Table 2-1 shows where to find information about operating the 11A34.

TABLE 2-1
Functions And Where They Are Described

Function	Described Under Heading
Offset, Size (V/div)	Waveform Acquisition: Vertical Menu; or for X-Y Display: Horizontal Menu.
Display \pm Ch 1, \pm Ch 2 \pm Ch 3, \pm Ch 4	Waveform Acquisition: Vertical Menu.
Polarity	Waveform Acquisition: Waveform Menu.
Trigger Selection	Trigger Source Major Menu and Polarity

Position and Offset

The 11301 and 11302 oscilloscopes assign position control to the Left Control knob by pressing the VERTICAL POS button. The Vertical Position control moves the trace as a user convenience. For example, when displaying multiple channels it may be desirable to set ground references for each trace on separate graticule lines. Position is a screen-related function; its units are divisions.

The offset function, accessed by pressing the VERTICAL OFFSET button, subtracts a precision voltage from the input signal. Changing offset moves the trace just as does the position control. However, if the deflection factor is subsequently changed, the effect is different.

Changing the sensitivity will increase or decrease the size of the display around some screen level (e.g., two divisions above graticule center) set by the Position control. When using a sensitivity that makes the displayed waveform larger than the screen, the Offset control is used to bring the waveform area of interest to the screen location established by the Position control.

The Position control has a range of plus and minus four divisions from graticule center, but the Offset control has a range defined in volts. Offset can be as much as 1000 divisions at 1 mV/division. The Offset control range is one volt for all sensitivities from 1 mV to 99.5 mV/division, but increases to 10 volts for sensitivities from 100 mV to 995 mV/division. For sensitivities from 1 volt to 10 volts/division, Offset control range increases to 100 volts.

The 11A34 attempts to maintain the user-selected offset voltage even though the offset range changes due to a change in sensitivity. An offset voltage of less than one volt will be maintained as the sensitivity is changed over the entire range of 1 mV/division to 10 V/division. A selected offset of greater than one volt is beyond the offset range for the most sensitive settings and will be reset to one volt when the sensitivity is increased to any value between 99.5 mV and 1 mV/division.

HF Limit

Two four-pole (24 dB/octave) bandwidth limit (low-pass) filters are available for each 11A34 channel. The purpose of these filters is to reduce the amplitude of unwanted noise or interference occurring at frequencies above the frequency of the signal of interest. The user has a choice of cut-off (-3 dB) frequencies, either 20 MHz or 100 MHz, independently for each channel. The trigger, auxiliary trigger, and display signal bandwidths for a channel are always the same. The auxiliary trigger is the signal sent to the right plug-in compartment.

DC Circuit Loading

AC coupling capacitors are connected differently in the 11A52 and 11A71 than in the 11A32 and 11A34. Figure 2-1 shows this difference.

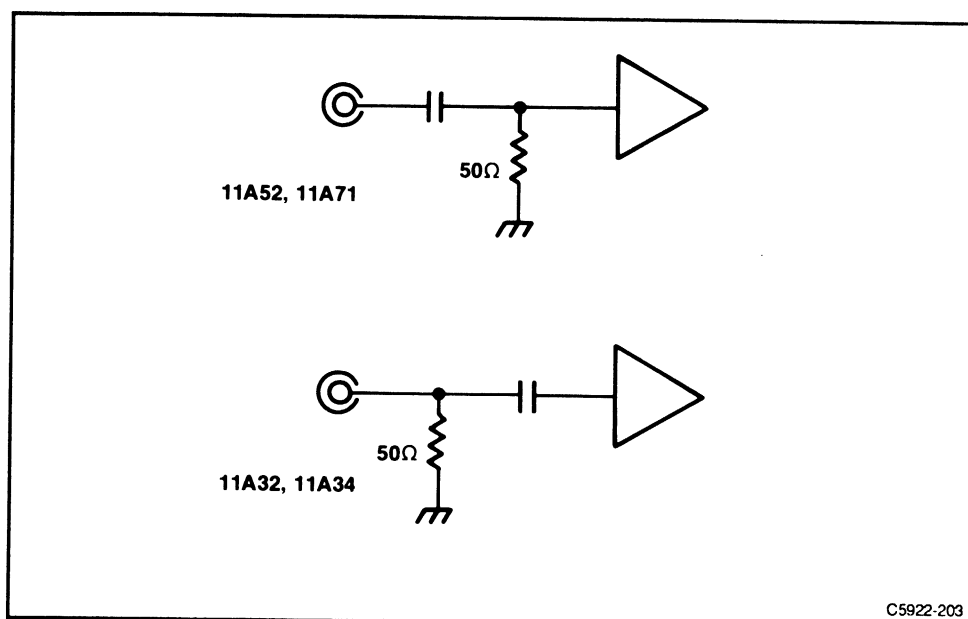

Figure 2-1. Location of AC coupling capacitors in plug-in amplifiers.

In the 11A52 and 11A71, the coupling capacitor isolates both the input termination and the amplifier from external dc voltages. However, the coupling capacitor in the 11A32 and 11A34 does not.

CAUTION

Always use caution when working with voltages in excess of 25 volts.

When 50 Ω Impedance mode is selected and input coupling is set to AC or DC, a 50 Ω termination resistance is connected directly from the 11A34 input connector to ground. Take care that the circuit connected to the 11A34 input will not be damaged by the 50 Ω load.

Switching from 1 M Ω to 50 Ω Impedance mode when more than 25 Vdc is present at the 11A34 input will exceed the peak input voltage specification and may damage the 11A34 input relay. A damaged relay could cause an error in calibration.

Adding and Subtracting Waveforms

NOTE

Before adding or subtracting waveforms, check that each channel's display is independently on screen.

The 11301 and 11302 allow the addition or subtraction of any two channels. Two channels within one plug-in unit may be added, or one channel may be added to a channel from another plug-in unit. A simple restriction applies. Each channel must be in its linear operating range. This is assured if each channel separately is within the screen area before addition or subtraction.

Those portions of a trace which are off screen will not be valid when brought back on screen using another channel's input signal or Offset control. This general restriction applies to any dual-channel oscilloscope.

Overdrive Recovery

Overdrive occurs when any 11A34 channel is driven out of its linear range of approximately ± 15 divisions.

The 11A34 has extraordinarily good overdrive recovery, and this feature may be used to greatly extend measurement resolution. For example, suppose a signal changes from -1.7 V to $+0.8$ V in 1 ns. The 11A34 could be used to determine if the signal stabilized immediately at $+0.8$ V or if perhaps had some small

aberration following the transition. By setting the 11A34 offset to +0.8 V and the sensitivity to 1 mV/division, aberrations of just 0.1% of the original transition will be 2.5 divisions in amplitude (0.1% of 2.5 V is 2.5 mV or 2.5 divisions at 1 mV/division).

Any amplifier will ultimately reach an equilibrium value after an input step (although its accuracy will determine how far that equilibrium value is from the correct value). The 11A34's ability to settle quickly to within a very small fraction of its equilibrium value is exceptional. The time it takes the 11A34 to settle to within a stated fraction of the equilibrium value is its overdrive recovery time.

Measuring the overdrive recovery time of an 11A34 takes some care and can lead to some surprising results. An interesting experiment is to use a very flat pulse generator, such as the Tektronix PG 506, to pulse the 11A34. Connect the generator's fast-rise output to the 11A34 input through a short (one foot or less) coaxial cable and select 50 Ω input impedance. Adjust the pulse amplitude to 1 volt. Set the 11A34 sensitivity to 1 mV/division. Each division now represents 0.1% of the input signal. Trigger the oscilloscope and observe the recovery of the 11A34 using 50 ns/division sweep rate. Now increase the cable length by about three feet (for example, use a 42-inch length of RG-58 cable, Tektronix part 012-0057-01) and observe the new waveform. See Figure 2-2.

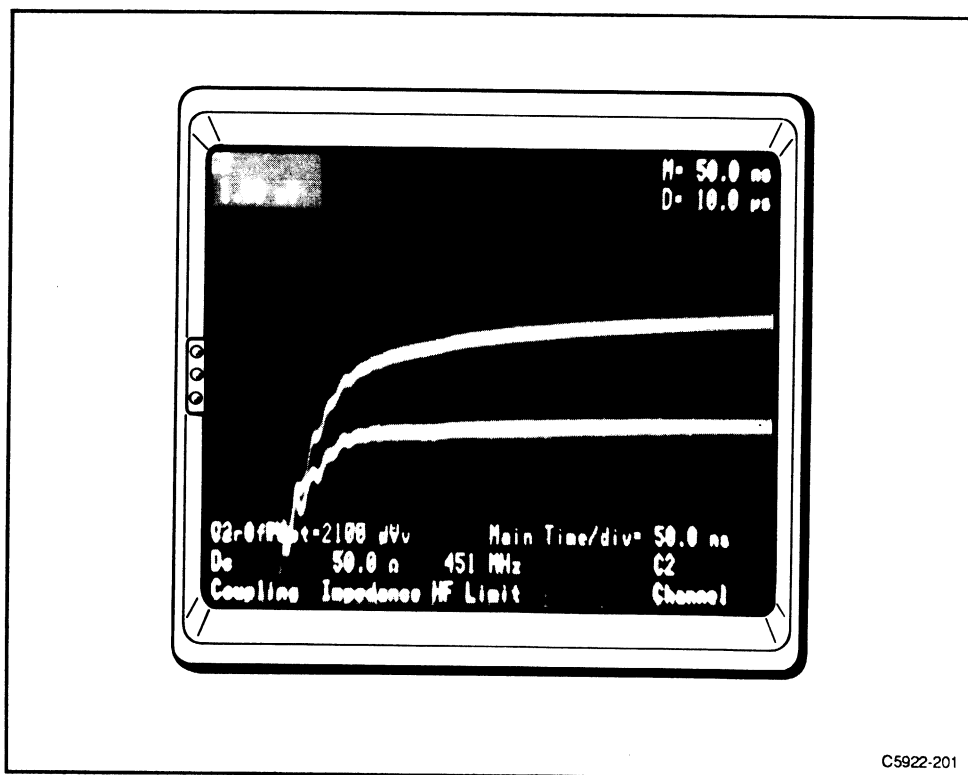

Figure 2-2. Overdrive recovery using long (top) and short (bottom) cables terminated in 50 Ω . Traces are offset two divisions and the photograph is a double exposure.

The waveform change is due to skin effect loss in the longer cable. What is surprising is that the skin effect loss persists for over 200 ns even though the total cable delay is only 5 ns. At 400 ns the loss is still 0.02%.

This experiment shows the importance of using a short cable to test overdrive recovery.

A second surprise is that skin effect loss disappears almost completely (after two cable delays) when one end is unterminated.

To observe this, use the short cable again, and select 1 M Ω input impedance on the 11A34. Insert a 2X attenuator between the cable and the pulse generator to improve the reverse termination and to provide the same amplitude signal as before. Observe the response and change cables again. Even at 0.1% per division the skin effect loss is hard to detect without the forward termination. The reason for this is that the skin effect loss is an increase in the effective series resistance of the cable. Without current, the cable develops no series voltage drop. See Figure 2-3.

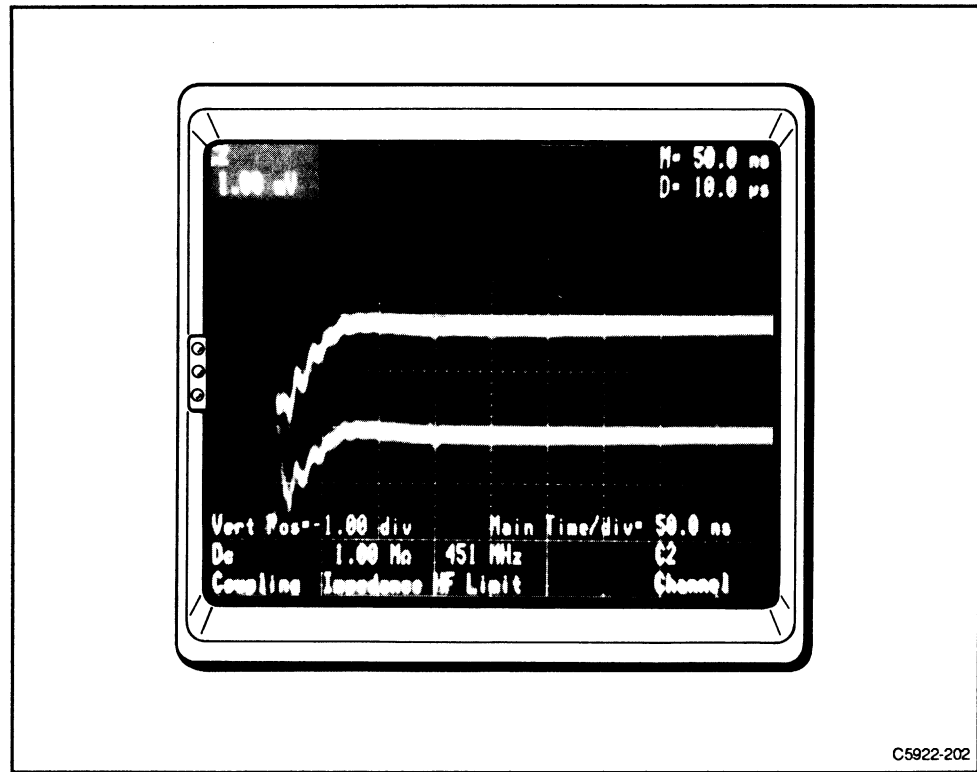

Figure 2-3. Overdrive recovery using long (top) and short (bottom) cables unterminated. Traces are offset two divisions and the photograph is a double exposure.

50Ω Overload

When the input impedance is set to 50Ω and the input voltage substantially exceeds 5 Vrms, the 11A34 will sense the overload, disconnect the 50Ω input termination, and connect the 1 MΩ termination. The Impedance menu will show 1 MΩ, and the mainframe will display the message: "Input channel N overload on LEFT/CENTER/RIGHT plugin," where N = 1, 2, 3, or 4.

To reset the input impedance to 50Ω, first correct the overload condition, then select 50Ω from the Impedance menu.

Active Probes

Using an active probe, such as the P6231, eliminates two options: Ac Coupling and 1 MΩ input impedance. Coupling options available when using such a probe are Off and Dc; the only Impedance available is 50Ω.

Probe ID

The Probe ID part of the Utility Menu is the means of selecting how the 11301 or 11302 responds to an ID button-push of recommended probes. All, or some combination of the following operations may be set to start in response to probe ID buttons. To display the Utility Menu, press the front-panel UTILITY button. For details, see the Probe ID part of the Waveform Acquisition subsection in the 11301 and 11302 User's Reference manual.

Pressing the probe ID button can initiate one or more of the following operations:

1. **Present a new display, or if that channel is already displayed, "select" the existing trace.** Pressing the ID button of a probe connected to an undisplayed left or center compartment channel will cause that channel to be displayed, unless doing so would exceed the maximum number of traces. Unlike the 11A34 display on/off button, pressing the probe ID button a second time will not remove the display. Probe ID button-presses for displayed channels will do two things: a) select the trace(s) using this channel, and b) momentarily brighten all traces using this channel.
2. **Stored settings can be sequentially recalled.** Pressing the probe ID button can cause a sequential recall of stored settings. The stored settings feature must be enabled using the Probe ID Utility menu. Settings must be stored as explained under STORE/RECALL Major Menu in the 11301 and 11302 User's Reference manual.

3. **The mainframe can "Autoset" to accommodate the input signal introduced by the probe.** The Autoset feature can be enabled or disabled using the Probe ID Utility menu. Autoset is the automatic setup of vertical deflection factor, triggering, and sweep speed to produce a meaningful display, e.g., two to five divisions of vertical deflection and two to five repetitions of the input signal. For more information, refer to Autoset in the 11301 and 11302 User's Reference manual.
4. **The mainframe can automatically measure the selected trace.** Automatic measurements of the selected trace can be initiated by pressing a probe ID button. The Automatic Measurements feature can be enabled or disabled using the Probe ID Utility menu. Such measurements are peak-to-peak, maximum, middle, and minimum voltages; frequency, period, pulse width, and duty cycle. For full information about automatic measurements, see Measure in the 11301 and 11302 User's Reference manual.
5. **An interrupt to the GPIB and RS-232-C can be generated.** Pressing a probe ID button will cause the mainframe to produce an SRQ to the GPIB and RS-232-C. For more information, refer to the GPIB/RS-232-C part of the 11301 and 11302 User's Reference manual.

Front-Panel Error Messages

- Message:** Internal DAC overflow on channel N of LEFT, CENTER, or RIGHT plug-in unit, where N = 1, 2, 3, or 4.
- Cause:** Some plug-in unit detected that a requested setting overflowed an internal DAC. Such overflow usually indicates defective hardware. In this situation, the plug-in unit sets the DAC to the limit nearer the requested setting.
- Message:** Bad Level 2 probe checksum on channel N of LEFT, CENTER, or RIGHT plug-in unit, where N = 1, 2, 3 or 4.
- Cause:** Some plug-in unit detected that a Level 2 TEKPROBE had failed or been improperly connected.

GPIB and RS-232-C Commands and Syntax

The following commands set parameters of a specified channel.

Header	Link	Argument		
CH<L1, L2, L3, L4, C1, C2, C3, C4, R1, R2, R3, R4>	COUPLING:	AC DC OFF		
	OFFSET: ¹	<NRx>		
	Volts/div	Offset Range	Resolution via RS-232-C, GPIB, or Numeric Entry	Step Size via front-panel Control knob
	1 mV to 99.5 mV 100 mV to 995 mV 1 V to 10 V	±1 V ±10 V ±100 V	25E-6 250E-6 2.5E-3	{ Coarse: 0.25 div. Fine: 0.025 div.
	BWHI:	<NRx> ≤24E6 >24E6 to ≤120E6 >120E6	HF Limit 20E6 100E6 250E6, 11301 250E6, 11302	
	IMPEDANCE:	<NRx> <1E3 ≥1E3	Impedance 50 1E6	
	SENSITIVITY: ¹	Sensitivity 1E-3 to 1.99E-3 2E-3 to 4.98E-3 5E-3 to 9.95E-3 10E-3 to 19.9E-3 20E-3 to 49.8E-3 50E-3 to 99.5E-3 100E-3 to 199E-3 200E-3 to 498E-3 500E-3 to 995E-3 1 to 1.99 2 to 4.98 5 to 10	Resolution (step size) 10E-6 20E-6 50E-6 100E-6 200E-6 500E-6 1E-3 2E-3 5E-3 10E-3 20E-3 50E-3	
	UNITS:	<qstring> (query only) The 11A34 answers a Units query with a units status message, which indicates the units of conversion of a probe connected to its Ch N input.		

¹ The numbers listed are those available at the input connectors. Connecting an attenuating probe will change the value by the probe attenuating factor (e.g., a 10X probe will change the value ±10 to ±100).

Header	Link	Argument
CH<L1,L2,L3, L4,C1,C2,C3,C4 R1,R2,R3,R4> (cont)	PROBE:	<qstring> (query only) This query-only link returns a quoted string indicating what type of probe is connected to the input. If a Level 1 TEKPROBE is connected, the query response is "Level 1." If a Level 2 TEKPROBE is connected, the query response is "Level 2/<probe_type>/<serial_number>." When neither Level 1 nor Level 2 TEKPROBE is connected, the query response is "NONE."

Legend:

CH<L1, L2, L3, L4, C1, C2, C3, C4, R1, R2, R3, R4>	L, C, and R mean Left, Center, and Right plug-in compartments; 1, 2, 3, and 4 mean Channel 1, Channel 2, Channel 3, and Channel 4, respectively.
COUPLING	Sets the specified channel input coupling.
OFFSET	Sets the specified channel offset.
BWHI	Sets the HF Limit (band width) of the specified channel.
NRx	Numeric representation.
IMPEDANCE	Sets the input impedance of the specified channel.
SENSITIVITY	Sets the deflection factor of the specified channel. Sensitivity is a channel-specific command which does not apply to compound waveforms.
qstring	Quoted string data.

Part 3

Specification

Performance Conditions

The specifications that follow apply when the instrument is in the condition of Enhanced Accuracy. Enhanced Accuracy is obtained by performing an Enhanced Calibration in the specific host mainframe after the system has reached thermal equilibrium, which requires 20 minutes warmup. Enhanced Accuracy is indicated on the crt display and remains in effect as long as the mainframe internal temperature change is less than 5° C from the temperature at which the calibration was performed. When the 5° C change does occur the accuracy condition becomes Not-Enhanced. In the Not-Enhanced condition those Characteristics that are temperature sensitive may not remain within the limits of these specifications.

TABLE 3-1
Electrical Characteristics

Characteristic	Performance Requirement
----------------	-------------------------

DISPLAY

DEFLECTION FACTOR (Sensitivity)

Calibrated Range	1 mV to 10 V/div.
------------------	-------------------

Enhanced DC Accuracy¹, either polarity, any HF Limit of 11A34 in 11301/11302 Mainframes, with on-screen cursors.

Without Probes

Volts/Div	ΔV DC Acc.	DC Balance	DC Offset Acc.
1 mV to 99.5 mV	$\pm(1.0\% + 0.04\text{div})$	$\pm(1\text{mV} + 0.13\text{div})$	$\pm(0.20\% + 0.5\text{mV})$
100 mV to 995 mV	$\pm(1.0\% + 0.04\text{div})$	$\pm(10\text{mV} + 0.13\text{div})$	$\pm(0.25\% + 5\text{mV})$
1 V to 10 V	$\pm(1.0\% + 0.04\text{div})$	$\pm(100\text{mV} + 0.13\text{div})$	$\pm(0.25\% + 50\text{mV})$

With P6134 Probe calibrated from 11301/11302 Calibrator output

Volts/Div	ΔV DC Acc.	DC Balance	DC Offset Acc.
10 mV to 995 mV	$\pm(1.0\% + 0.04\text{div})$	$\pm(12\text{mV} + 0.13\text{div})$	$\pm(0.25\% + 5\text{mV})$
1 V to 9.95 V	$\pm(1.0\% + 0.04\text{div})$	$\pm(120\text{mV} + 0.13\text{div})$	$\pm(0.25\% + 50\text{mV})$
10 V to 100 V	$\pm(1.0\% + 0.04\text{div})$	$\pm(1.2\text{V} + 0.13\text{div})$	$\pm(0.25\% + 0.5\text{V})$
Probe tip TC term	100 ppm/°C	na	na

¹For absolute dc accuracy of single-point measurements using Offset, add the DC Offset Accuracy, DC Balance and ΔV DC Accuracy terms. Apply the ΔV DC Accuracy only to the difference between the Vertical Position setting and the measurement point.

TABLE 3-1 (cont)
Electrical Characteristics

Characteristic	Performance Requirement
-----------------------	--------------------------------

DISPLAY (cont)

DEFLECTION FACTOR (Sensitivity), cont.

Enhanced DC Accuracy¹, either polarity, any HF Limit, of 11A34 in 11301/11302 Mainframes, with on-screen cursors.

With P6231 Probe calibrated from 11301/11302 Calibrator output

Volts/Div	ΔV DC Acc.	DC Balance	DC Offset Acc.
10 mV to 995 mV	±(1.1% + 0.04div)	±(10mV + 0.13div)	±(0.20% + 2mV)
≥1 V	±(1.1% + 0.04div)	±(100mV + 0.13div)	±(0.20% + 2mV)
Probe Tip TC term	100 ppm/°C		

¹For absolute dc accuracy of single-point measurements using Offset, add the DC Offset Accuracy, DC Balance and ΔV DC Accuracy terms. Apply the ΔV DC Accuracy only to the difference between the Vertical Position setting and the measurement point.

TABLE 3-1 (cont)
Electrical Characteristics

Characteristic	Performance Requirement
----------------	-------------------------

DISPLAY (cont)

DEFLECTION FACTOR (Sensitivity), cont.

Coarse Resolution	1, 2, 5 sequence.
-------------------	-------------------

Fine Resolution depends on
 Deflection Factor, as follows:

Rotating the Fine control one increment will change the Deflection Factor by 1% of the next more-sensitive Coarse setting.

For example, with deflection factor set to 198 mV, rotating the Fine control counterclockwise will cause this sequence of sensitivities: 199 mV, 200 mV, 202 mV, etc. Rotating the Fine control clockwise from 204 mV/div will cause the reverse sequence (202 mV, 200 mV, 199 mV, etc.).

OFFSET

Accuracy	See Deflection Factor Accuracy, which precedes this characteristic.
Range, Resolution depend on Deflection Factor, as follows:	
between 1 mV and 99.5 mV/div.	±1 V. Coarse and fine resolution are 0.25 div. (250 μV) and 0.025 div. (25 μV), respectively.
between 0.1 V and 0.995 V/div.	±10 V. Coarse and fine resolution are 0.25 div. (2.5 mV) and 0.025 div. (250 μV), respectively.
between 1 V and 10.0 V/div.	±100 V. Coarse and fine resolution are 0.25 div (25 mV) and 0.025 div. (2.5 mV), respectively.

TABLE 3-1 (cont)
Electrical Characteristics

Characteristic	Performance Requirement	
DISPLAY (cont)		
FREQUENCY RESPONSE		
High Frequency Limit (-3dB point) of Display, Auxiliary, & Trig signals, Z _{in} =50Ω and Calculated Rise Time	Type of Mainframe	
	11301	11302
Volts/Division	11301	11302
≥10 mV	250 MHz 1.4 ns	250 MHz 1.4 ns
5 mV – 9.95 mV	250 MHz 1.4 ns	250 MHz 1.4 ns
2 mV – 4.98 mV	200 MHz 1.8 ns	250 MHz 1.4 ns
1 mV – 1.99 mV	200 MHz 1.8 ns	200 MHz 1.8 ns
High Frequency -3dB point		
100 MHz Limit	100 MHz ±30%.	
20 MHz Limit	20 MHz ±30%.	
Low Frequency -3 dB point, ac coupled Display, Trig, and Auxiliary signals	10 Hz maximum.	

TABLE 3-1 (cont)
Electrical Characteristics

Characteristic	Performance Requirement
INPUT CHARACTERISTICS	
Maximum Input Voltage, DC Coupled, $Z = 1\text{ M}\Omega$	$\pm 500\text{ V}$ (dc+peak ac). Derate at 20 dB per decade from 1 MHz to 5.0 V at 100 MHz.
Maximum Input Voltage, AC Coupled, $Z = 1\text{ M}\Omega$	$\pm 500\text{ V}$ (dc+peak ac). Derate at 20 dB per decade from 1 MHz to 5.0 V at 100 MHz.
Maximum Input Voltage, AC or DC Coupled, $Z = 50\Omega$	5 Vrms (0.5 W) or 0.5 watt-second pulses not exceeding 25 V peak.
Input Disconnect Threshold	5 Vrms minimum.
Power-Down Input Impedance	1 M Ω .
Input Impedance (50 Ω , dc coupled)	50 Ω within 1/2%; VSWR less than 1.2:1 for V/div < 1 V; VSWR less than 1.3:1 for V/div from 1 V to 10 V, dc to 350 MHz.
Input Impedance (1 M Ω , dc coupled)	1 M Ω within 1/2% in parallel with approximately 15 pF.
Input Impedance (1 M Ω , ac coupled)	1 M Ω within 1/2%, in series with 0.022 μF and in parallel with approximately 15 pF.
Input Bias Current	Less than 100 pA.

TABLE 3-1 (cont)
Electrical Characteristics

Characteristic	Performance Requirement
MISCELLANEOUS	
Overdrive Recovery Time	
1 mV to 9.95 mV/div	<50 ns to 0.3% + 0.2 div for Vin of <2.0 V.
100 mV to 995 mV/div	<50 ns to 1.0% for Vin of <20 V.
1.0 V to 10.0 V/div	<50 ns to 1.0% for Vin of <200 V.
Typical Noise	
1.0 mV to 1.99 mV/div	0.12 div, rms.
2.0 mV to 4.98 mV/div	0.06 div, rms.
5.0 mV to 9.95 mV/div	0.025 div, rms.
10.0 mV to 99.5 mV/div	0.014 div, rms.
100 mV to 995 mV/div	0.014 div, rms.
1.0 V to 10.0 V/div	0.014 div, rms.
DC Drift with Temperature	200 μ V/ $^{\circ}$ C, or less, at any sensitivity. ¹
Channel Isolation	At least 50:1 display ratio ² , dc - 300 MHz.
Common Mode Rejection Ratio	At least 20:1, dc to 50 MHz, 10-div reference signal on each input.
Probe Compatibility	The 11A34 is compatible with Level 1 and Level 2 TEKPROBES. ³

¹Dc drift can be calibrated out by invoking a calibration (Enhanced Accuracy) at any specific operating temperature.

$$^2\text{Display ratio} = \frac{\text{Amplitude (div)} \times \text{V/div (driven channel)}}{\text{Error amplitude (div)} \times \text{V/div (undriven channel)}}$$

³TEKPROBE is Tektronix' name for the interface used with probes designed for the 11000-series of oscilloscopes and plug-in units. TEKPROBES have output connectors with one or more spring loaded coding pins. Two categories of TEKPROBES are:

Level 1

A level 1 probe, which uses analog encoding to indicate the probe's scale factor to the plug-in unit.

Level 2

A level 2 probe, which uses an EEPROM to store data about the probe's transfer units, scale factor, and output voltage scale factor. Such data are serially encoded, then stored in the EEPROM. The probe data is intended to be read once at instrument power-up or when the probe is first connected to a plug-in unit (that is, at probe power-up).

TABLE 3-2
Environmental Characteristics

Characteristic	Information
Ambient Temperature (external to main frame)	
Operating within specs.	0° to 50° C., mainframe ambient.
Nonoperating	-40° to +75° C.
Humidity, Operating and Nonoperating	Five days, per MIL-T-28800C, Type III, class 5 as described in 3.9.2.2 and 4.5.5.1.2.2.
Altitude	
Operating	To 4,570 m (15,000 ft.).
Nonoperating	To 15,200 m (50,000 ft.).
Vibration	
Operating, installed on Flexible Extender	MIL-T-28800C, Sec. 4.5.5.3.1, type III, class 5.
Shock, Nonoperating (not installed in mainframe)	MIL-T-28800C, Sec. 4.5.5.4.1, type III, class 5.
Bench Handling (operating and nonoperating)	MIL-T-28800C, Sec. 4.5.5.4.3, type III, class 5.
Packaged Product Vibration and Shock	
Vibration and Bounce of Packaged Product	Meets ASTM D999-75, Method A (NSTA Project 1A-B-1).
Drop of Packaged Product	Meets ASTM D775-61, Paragraph 5 (NSTA Project 1A-B-2).
Electromagnetic Compatibility	MIL. STD. 461B. FCC Part 15, Subpart J, Class A. VDE 0871/6.78, Class B.

Table 3-3
Physical Characteristics

Characteristic	Information
Weight (max)	2 lb. 7 oz. (1.1 kg.)
Weight of Packaged Product (max)	5 lb. 5 oz. (2.4 kg.)
Dimensions (max)	Refer to Figure 3-1.

Recommended Probes

Tektronix recommends these probes for use with the 11A34:

P6134 Subminiature 10X Passive Probe with ID. With 1 M Ω inputs, the P6134's input impedance is 10 M Ω in parallel with 10.5 pF. The P6134 is a Level 1 probe.

P6231 Low Impedance Subminiature 10X Active Probe. The P6231 has a bandwidth of 1.5 GHz, input impedance of 450 Ω , and dc offset of ± 5 V controlled by the 11A34. The P6231 is a Level 2 probe.

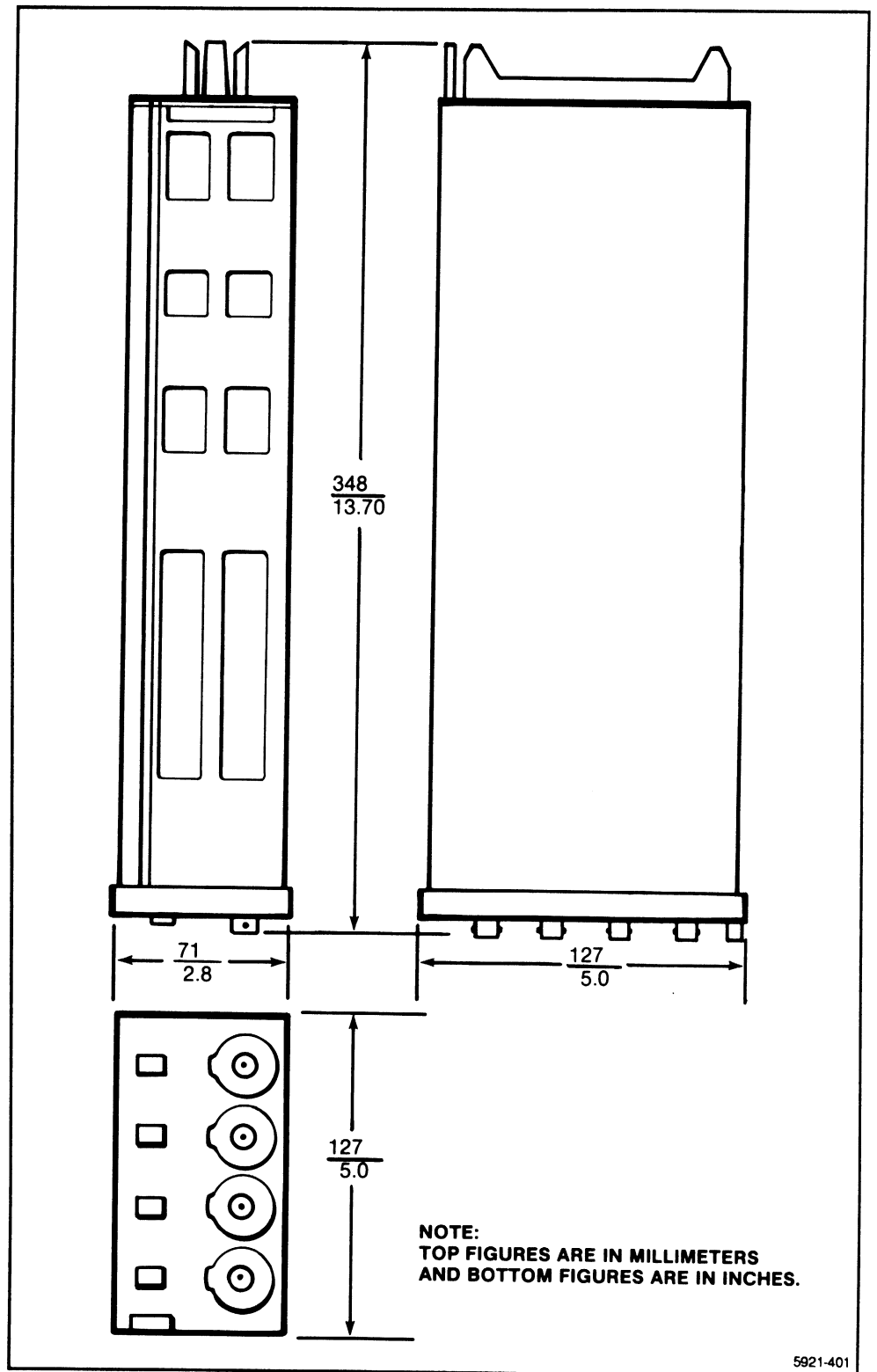
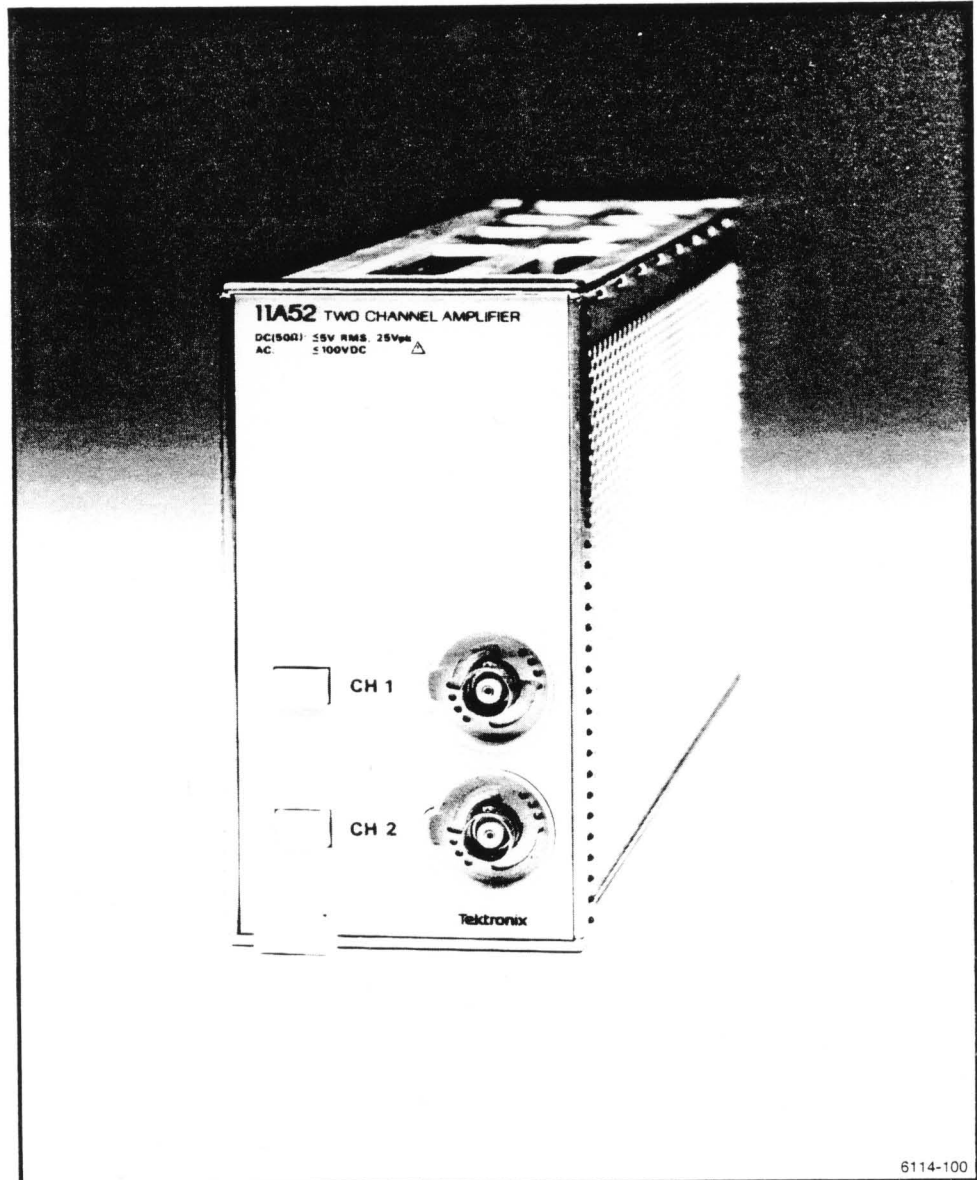

Figure 3-1. Dimensions of 11A34.

Appendix A—Glossary

Deflection factor	The ratio of input signal to response in the 11000 system. The reciprocal of sensitivity.
Display on/off button	The front-panel, plug-in button that designates a channel for display, or removes a channel from the display.
Mainframe	Any 11000-series oscilloscope exclusive of plug-in units.
Offset	A control that allows the user to subtract a precision voltage from the input signal to vary the position of the displayed signal.
ON/STANDBY	The front-panel power control on 11000-series mainframes. When set to ON, applies operating power to all circuits. When set to STANDBY, the mainframe dc power supply supplies power to the counter-timer crystal oven (Option 1T).
Overdrive	A condition in which amplifiers are driven into a non-linear operating range. Typically many divisions off screen.
Overload	The condition existing when a potentially damaging voltage is applied to the input connector.
Toggle	To switch alternately between two functions (e.g., on and off).

11A52 Two Channel Amplifier



11A52 Features and Functions

Features

- DC to 400 MHz bandwidth (in 11302)
- Dual trace
- Calibrated sensitivities from 1 mV to 10 V/division
- 50 Ω input impedance
- High-resolution, calibrated DC offset (0.25 division/increment, coarse; 0.025 division/increment, fine)
- Fast overdrive recovery

Functions

Signals applied to the CH 1 and CH 2 input connectors can be displayed or removed from the display by pressing the display on/off buttons adjacent to the input connectors.

All other 11A52 functions are controlled through the host mainframe. Such mainframe-controlled functions are:

- Sensitivity, Coarse and Fine, over a range of 1 mV to 10 V/division.
- Vertical Offset.
- Coupling: Ac, Dc, or Off.
- HF Limit: 100 MHz or 20 MHz.
- Display Polarity: normal or inverted.
- Trigger Polarity: normal or inverted.
- Combination of Display Channels: see Operating Information section of mainframe User's Reference manual.
- Combination of Trigger Channels: same as Display Channels; Operating Information section of mainframe User's Reference manual.

Contents

Part 1—General Information

Technical Manuals.....	1-1
Contents of this Supplement.....	1-1
11A52 Service Manual.....	1-2
Plug-in to Mainframe Compatibility.....	1-2
Initial Inspection.....	1-2
Operating Temperature.....	1-3
Installing and Removing the 11A52.....	1-3
Instrument Options.....	1-4
Packaging for Shipment.....	1-5

Part 2—Operating the 11A52 in 11301 and 11302 Mainframes

Display On/Off.....	2-1
Selecting Coupling and HF Limit.....	2-1
Other Functions.....	2-2
Position and Offset.....	2-2
HF Limit.....	2-3
DC Circuit Loading.....	2-3
Adding and Subtracting Waveforms.....	2-5
Overdrive Recovery.....	2-5
50Ω Overload.....	2-6
Active Probes.....	2-6
Probe ID.....	2-6
Front-Panel Error Messages.....	2-7
GPIB and RS-232-C Commands and Syntax.....	2-8

Part 3—Specification

Performance Conditions.....	3-1
Electrical Characteristics.....	3-1
Environmental Characteristics.....	3-6
Physical Characteristics.....	3-7
Recommended Probes.....	3-7

Appendix A—Glossary.....	A-1
--------------------------	-----

Illustrations

- 1-1 Installing a plug-in unit in a mainframe oscilloscope.....1-4
- 2-1 Location of AC coupling capacitors in plug-in amplifiers.....2-3
- 3-1 Dimensions of 11A52.....3-8

Tables

- 2-1 Functions And Where They Are Described.....2-2
- 3-1 Electrical Characteristics.....3-1
- 3-2 Environmental Characteristics.....3-6
- 3-3 Physical Characteristics.....3-9

Part 1

General Information

Technical Manuals

This Supplement to the User's Reference manuals is a standard accessory to the 11A52. An 11A52 Service manual is also available.

Contents of this Supplement

This Supplement contains the following three parts:

Part 1—GENERAL INFORMATION, describes mainframe to plug-in unit compatibility, explains how to install and remove the 11A52 from a mainframe, outlines any options available for the 11A52, and gives details about packaging for shipment.

Most 11A52 functions, and how they are operated, are described in the Operating Information section of the mainframe User's Reference manuals. Such functions are those that are common to all amplifier plug-in units. Examples of common functions are position, sensitivity, coupling, and bandwidth limit. Only those functions unique to the 11A52-11301/11302 combination are explained in the following parts.

Part 2—OPERATING THE 11A52 IN 11301 AND 11302 MAINFRAMES, explains how to operate those 11A52 functions not covered in the 11301 and 11302 User's Reference manual.

Part 3—SPECIFICATION, gives detailed specifications of all 11A52-mainframe oscilloscope combinations.

11A52 Service Manual

WARNING

The 11A52 Service manual is for use by qualified service personnel only. To avoid personal injury, do not perform any service other than that contained in the Operator's manual unless you are qualified to do so. Refer to the Operators Safety Summary and Service Safety Summary before performing any service.

The 11A52 Service Manual contains the following information:

Section 1—GENERAL INFORMATION.

Section 2—THEORY OF OPERATION.

Section 3—MAINTENANCE.

Section 4—CHECKS AND ADJUSTMENT.

Section 5—INSTRUMENT OPTIONS.

Section 6—REPLACEABLE ELECTRICAL PARTS.

Section 7—DIAGRAMS AND CIRCUIT BOARD ILLUSTRATIONS.

Section 8—REPLACEABLE MECHANICAL PARTS.

Plug-in to Mainframe Compatibility

The 11A52 is designed for use in the 11301, 11302, 11401, 11402, and future plug-in mainframes. 11A52 bandwidth varies depending on host mainframe. Details about bandwidth are included in Part 3, Specification, of this subsection, and in the Tektronix Corporate Catalog. Refer to the Tektronix Corporate Catalog for complete compatibility information.

Initial Inspection

This instrument was inspected mechanically and electrically before shipment. It should be free of marks or scratches and should meet all electrical specifications. To confirm this, inspect the 11A52 for physical damage incurred in transit. Instrument performance may be verified by using the procedure given in Part 5, Incoming Inspection and Performance Verification, in the 11A52 User's Reference Supplement, Tektronix Part 070-6114-00. If you find damage or deficiency, contact your local Tektronix Field Office or representative.

Operating Temperature

The 11A52 can be operated where the ambient air temperature is between 0° and +50° C and can be stored in ambient temperatures from -40° to +75° C. After storage at temperatures outside the operating limits, allow the chassis to reach operating temperature limits before applying power.

Installing and Removing the 11A52

CAUTION

To avoid instrument damage set the mainframe ON/STANDBY switch to STANDBY before installing or removing the 11A52.

When installed in the 11301/11302 left or center plug-in compartment, the 11A52 will provide a conventional display.

When installed in the center or right plug-in compartment of the 11301/11302, the 11A52 will also provide the X (horizontal) part of an X-Y display, or provide a trigger signal for the mainframe time base.

To install the 11A52 in any 11000-series oscilloscope mainframe, set the mainframe ON/STANDBY switch to STANDBY. Align the grooves in the top and bottom of the 11A52 with the guides in the mainframe plug-in compartment, then insert the 11A52 into the mainframe until its front panel is flush with the front panel of the mainframe.

To remove the 11A52 from a mainframe, set the mainframe ON/STANDBY switch to STANDBY. Then pull the release latch (see Fig. 1-1) to disengage the unit from the mainframe, and pull the 11A52 straight out of the plug-in compartment.

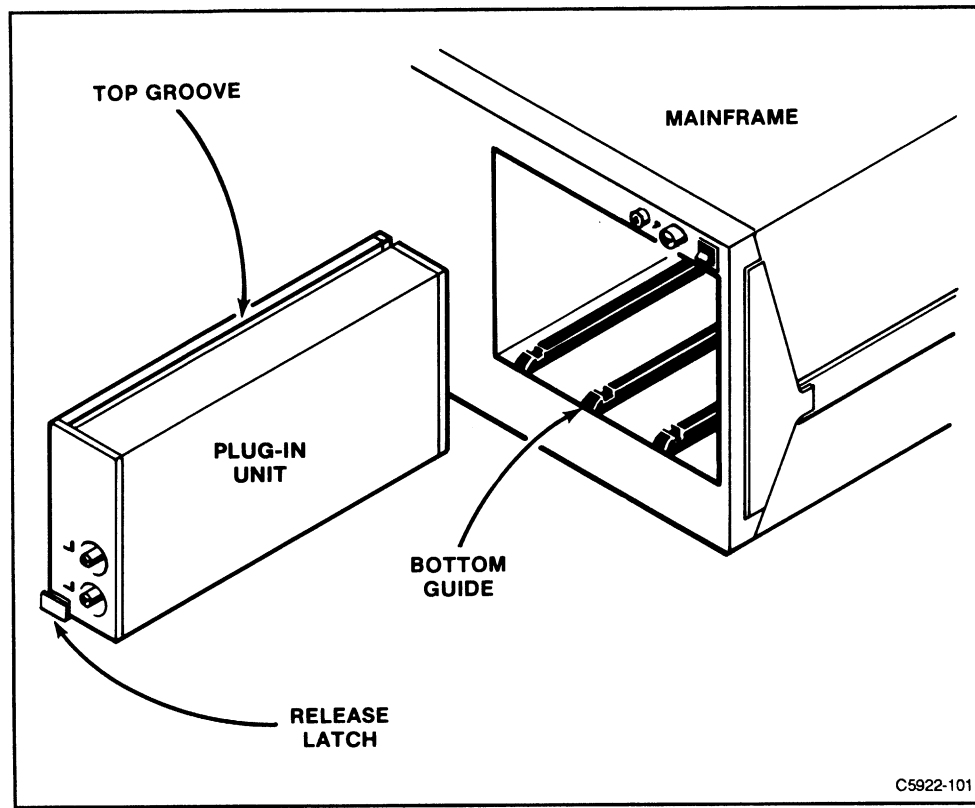

Figure 1-1. Installing a plug-in unit in a mainframe oscilloscope.

Instrument Options

Option 25 includes two P6231 probes.

Packaging for Shipment

If this instrument is to be shipped by commercial transportation, we recommend that it be packaged in the original manner. The original carton and packaging material can be saved and reused for this purpose.

NOTE

Package and ship plug-in units and mainframes separately.

If the 11A52 is to be shipped to a Tektronix Service Center for service or repair, attach a tag to the instrument. On the tag, include the following information:

- Name and address of the instrument owner;
- Name of a person at your firm who can be contacted about the instrument;
- Complete instrument type and serial number; and
- A description of the service required.

If the original package is not available or is not fit for use, package the 11A52 as follows:

1. Obtain a corrugated cardboard carton with inside dimensions at least six inches greater than the instrument dimensions. Use a carton with a test strength of at least 200 pounds.
2. Fully wrap the 11A52 with anti-static sheeting, or its equivalent, to protect the finish.
3. Cushion the 11A52 on all sides by tightly packing dunnage or urethane foam between the carton and the instrument. Allow three inches of packing on each side.
4. Seal the carton with shipping tape or with industrial staples.
5. Mark the address of the Tektronix Service Center and your return address on the carton in one or more prominent places.

Part 2

Operating the 11A52 in 11301 and 11302 Mainframes

Display On/Off

The 11A52 has only two front-panel controls—the display on/off buttons. Pressing a display on/off button will cause its channel, and signal, to be displayed or removed from the display (the function "toggles"). When a channel is displayed, its label (CH 1 or CH 2) will be lighted.

Selecting Coupling and HF Limit

To select the desired setting for Coupling and HF Limit proceed as follows:

- 1a. If no trace is displayed, press any plug-in display on/off button to create a trace.
- 1b. If several traces are displayed, select a channel by touching the desired trace description at the top of the crt.
2. Press any VERTICAL button – OFFSET, SIZE, or POS. This button-press will cause the Control Menu to be displayed.
3. Touch the desired function's label. Successive touches will change its state.

Other Functions

Other 11A52 functions are controlled within the 11301 or 11302 mainframe, and their operation is described in detail in Section 2, Operating Information, of the 11301 and 11302 User's Reference manual. Table 2-1 shows where to find information about operating the 11A52.

TABLE 2-1
Functions And Where They Are Described

Function	Described Under Heading
Offset, Size (V/div)	Waveform Acquisition: Vertical Menu; or for X-Y Display: Horizontal Menu.
Display	
Select \pm Ch 1, \pm Ch 2	Waveform Acquisition: Waveform Menu.
Polarity	Waveform Acquisition: Waveform Menu.
Trigger Selection and Polarity	Trigger Source Major Menu.

Position and Offset

The 11301 and 11302 oscilloscopes assign position control to the Left Control knob by pressing the VERTICAL POS button. The Vertical Position control moves the trace as a user convenience. For example, when displaying multiple channels it may be desirable to set ground references for each trace on separate graticule lines. Position is a screen-related function; its units are divisions.

The offset function, accessed by pressing the VERTICAL OFFSET button, subtracts a precision voltage from the input signal. Changing offset moves the trace just as does the position control. However, if the deflection factor is subsequently changed, the effect is different.

Changing the sensitivity will increase or decrease the size of the display around some screen level (e.g., two divisions above graticule center) set by the Position control. When using a sensitivity that makes the displayed waveform larger than the screen, the Offset control is used to bring the waveform area of interest to the screen location established by the Position control.

The Position control has a range of plus and minus four divisions from graticule center, but the Offset control has a range defined in volts. Offset can be as much as 1000 divisions at 1 mV/division. The Offset control range is one volt for all sensitivities from 1 mV to 99.5 mV/division, but increases to 10 volts for sensitivities from 100 mV to 995 mV/division. For sensitivities from 1 volt to 10 volts/division, Offset control range increases to 100 volts.

The 11A52 attempts to maintain the user-selected offset voltage even though the offset range changes due to a change in sensitivity. An offset voltage of less than one volt will be maintained as the sensitivity is changed over the entire range of 1 mV/division to 10 V/division. A selected offset of greater than one volt is beyond the offset range for the most sensitive settings and will be reset to one volt when the sensitivity is increased to any value between 99.5 mV/division and 1 mV/division.

HF Limit

Two four-pole (24 dB/octave) bandwidth limit (low-pass) filters are available for each 11A52 channel. The purpose of these filters is to reduce the amplitude of unwanted noise or interference occurring at frequencies above the frequency of the signal of interest. The user has a choice of cut-off (-3dB) frequencies, either 20 MHz or 100 MHz, independently for each channel. The trigger, auxiliary trigger, and display signal bandwidths for a channel are always the same. The auxiliary trigger is the signal sent to the right plug-in compartment.

DC Circuit Loading

AC Coupling capacitors are connected differently in the 11A52 and 11A71 than in the 11A32 and 11A34. Figure 2-1 shows this difference.

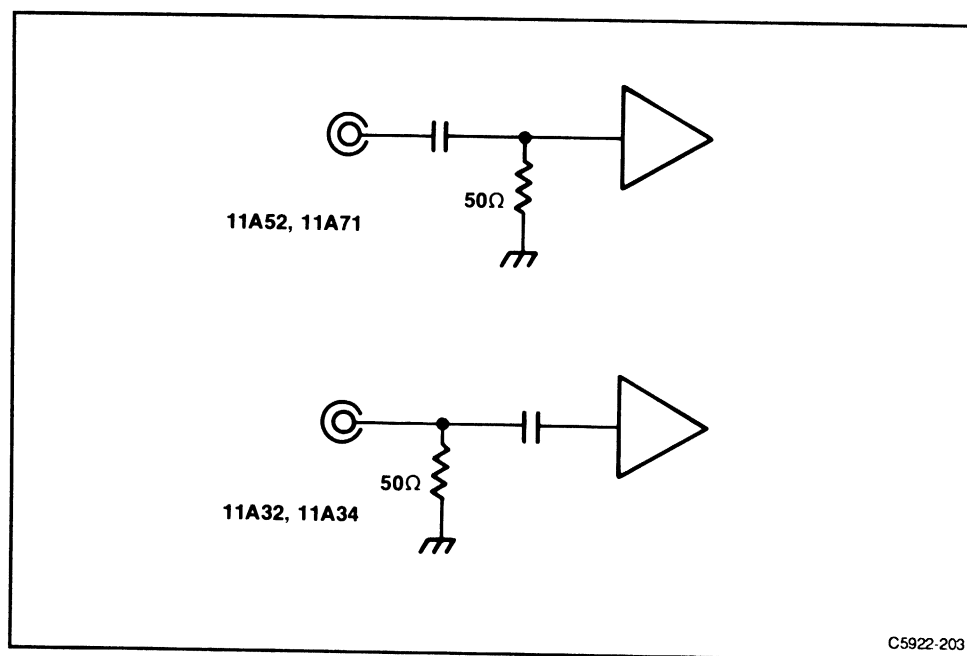

Figure 2-1. Location of AC coupling capacitors in plug-in amplifiers.

In the 11A52 and 11A71, the coupling capacitor isolates both the input termination and the amplifier from external dc voltages. Avoid inadvertently selecting Dc Coupling if your circuit will be damaged by the resulting 50Ω termination to ground. See Caution below. The coupling capacitor in the 11A32 and 11A34 does not isolate the input termination from external dc voltages.

When Ac Coupling is selected, the 11A52 coupling capacitor allows the user to test low-impedance circuits that are elevated in potential by up to 100 volts dc without loading the circuit at dc. Passive attenuating probes such as the P6056 or P6057 eliminate the dc loading and lower the low-frequency -3 dB point.

In the Off coupling mode the ac coupling capacitor precharges in about three seconds to the average dc voltage of the circuit being tested. Always use the Off mode when connecting the 11A52 input to a circuit that may have more than 25 volts (the 11A52 peak input voltage rating) present. This will precharge the coupling capacitor. Wait a few seconds before selecting Ac Coupling.

The coupling capacitor is discharged upon removal of the external circuit.

CAUTION

Always use caution when working with voltages in excess of 25 volts.

When the input coupling is set to Dc, a 50Ω termination resistance is connected directly from the 11A52 input connector to ground. Take care that the circuit connected to the 11A52 input will not be damaged by the 50Ω load.

Two ways of unintentionally invoking Dc Coupling in the 11A52 are:

- 1. Invoking Autoset, because the Autoset process starts by searching for a dc voltage, and*
- 2. Recalling a stored control setting that dictates Dc Coupling.*

Switching coupling to Dc when more than 25 V is present at the 11A52 input will exceed the peak input voltage specification, and may damage the 11A52 input relay. A damaged relay could cause an error in calibration.

Adding and Subtracting Waveforms

NOTE

Before adding or subtracting waveforms, check that each channel's display is independently on screen.

The 11301 and 11302 allow the addition or subtraction of any two channels. Two channels within one plug-in unit may be added, or one channel may be added to a channel from another plug-in unit. A simple restriction applies. Each channel must be in its linear operating range. This is assured if each channel separately is within the screen area before addition or subtraction.

Those portions of a trace which are off screen will not be valid when brought back on screen using another channel's input signal or Offset control. This general restriction applies to any dual-channel oscilloscope.

Overdrive Recovery

Overdrive occurs when any 11A52 channel is driven out of its linear range of approximately ± 15 divisions.

The 11A52 has extraordinarily good overdrive recovery, and this feature may be used to greatly extend measurement resolution. For example, suppose a signal changes from -1.7 V to $+0.8$ V in 1 ns. The 11A52 could be used to determine if the signal stabilized immediately at $+0.8$ V or if perhaps had some small aberration following the transition. By setting the 11A52 offset to $+0.8$ V and the sensitivity to 1 mV/division, aberrations of just 0.1% of the original transition will be 2.5 divisions in amplitude (0.1% of 2.5 V is 2.5 mV or 2.5 divisions at 1 mV/division).

Any amplifier will ultimately reach an equilibrium value after an input step (although its accuracy will determine how far that equilibrium value is from the correct value). The 11A52's ability to settle quickly to within a very small fraction of its equilibrium value is exceptional. The time it takes the 11A52 to settle to within a stated fraction of the equilibrium value is its overdrive recovery time.

Measuring the overdrive recovery time of an 11A52 takes some care and can lead to some surprising results. An interesting experiment is to use a very flat pulse generator, such as the Tektronix PG 506, to pulse the 11A52. Connect the generator's fast-rise output to the 11A52 input through a short (one foot or less) coaxial cable. Adjust the pulse amplitude to 1 volt. Set the 11A52 sensitivity to 1 mV/division. Each division now represents 0.1% of the input signal. Trigger the oscilloscope and observe the recovery of the 11A52 using 50 ns/division sweep rate. Now increase the cable length by about three feet (for example, use a 42-inch length of RG-58 cable, Tektronix part 012-0057-01) and observe the new waveform.

The waveform change is due to skin effect loss in the longer cable. What is surprising is that the skin effect loss persists for over 200 ns even though the total cable delay is only 5 ns. At 400 ns the loss is still 0.02%.

This experiment shows the importance of using a short cable to test overdrive recovery.

50 Ω Overload

When the input voltage substantially exceeds 5 Vrms, the 11A52 will sense the overload and disconnect the 50 Ω input termination. The mainframe will display the message: "Input channel N overload on LEFT/CENTER/RIGHT plugin," where N = 1 or 2.

To reconnect the 50 Ω input termination, first correct the overload condition, then select Ac or Dc from the Coupling menu.

Active Probes

Using an active probe, such as the P6231, eliminates the possibility of Ac Coupling. Coupling options available when using such a probe are Off and Dc.

Probe ID

The Probe ID part of the Utility Menu is the means of selecting how the 11301 or 11302 responds to the ID button of recommended probes. All or some combination of the following operations may be set to start in response to probe ID buttons. To display the Utility Menu, press the front-panel UTILITY button. For details, see the Probe ID part of the Waveform Acquisition subsection in the 11301 and 11302 User's Reference manual.

Pressing the probe ID button can initiate one or more of the following operations:

1. **Present a new display, or if that channel is already displayed, "select" the existing trace.** Pressing the ID button of a probe connected to an undisplayed left or center compartment channel will cause that channel to be displayed, unless doing so would exceed the maximum number of traces. Unlike pressing the 11A52 display on/off button, pressing the probe ID button a second time will not remove the display.

Probe ID button-presses for displayed channels will do two things: a) select the trace(s) using this channel, and b) momentarily brighten all traces using this channel.

2. **Stored settings can be sequentially recalled.** Pressing the probe ID button can cause a sequential recall of stored settings. The stored settings feature must be enabled using the Probe ID Utility menu. Settings must be stored as explained under STORE/RECALL Major Menu in the 11301 and 11302 User's Reference manual.
3. **The mainframe can "Autoset" to accommodate the input signal introduced by the probe.** The Autoset option can be enabled or disabled using the Probe ID Utility menu. Autoset is the automatic setup of vertical deflection factor, triggering, and sweep speed to produce a meaningful display, e.g., two to five divisions of vertical deflection and two to five repetitions of the input signal. For more information, refer to Autoset in the 11301 and 11302 User's Reference manual.
4. **The mainframe can automatically measure the selected trace.** Automatic measurements of the selected trace can be initiated by pressing a probe ID button. The Automatic Measurements feature can be enabled or disabled using the Probe ID Utility menu. Such measurements are peak-to-peak, maximum, middle, and minimum voltages; frequency, period, pulse width, and duty cycle. For full information about automatic measurements, see Measure in the 11301 and 11302 User's Reference manual.
5. **An interrupt to the GPIB and RS-232-C can be generated.** Pressing a probe ID button will cause the mainframe to produce an SRQ to the GPIB and RS-232-C. For more information, refer to the GPIB/RS-232-C part of the 11301 and 11302 User's Reference manual.

Front-Panel Error Messages

- Message:** Internal DAC overflow on channel N of LEFT, CENTER, or RIGHT plug-in unit, where N = 1 or 2.
- Cause:** Some plug-in unit detected that a requested setting overflowed an internal DAC. Such overflow usually indicates defective hardware. In this situation, the plug-in unit sets the DAC to the limit nearer the requested setting.
- Message:** Bad Level 2 probe checksum on channel N of LEFT, CENTER, or RIGHT plug-in unit, where N = 1 or 2.
- Cause:** Some plug-in unit detected that a Level 2 TEKPROBE had failed or been improperly connected.

GPIB and RS-232-C Commands and Syntax

The following commands set parameters of a specified channel.

Header	Link	Argument		
CH<L1, L2, C1, C2, R1 or R2>	COUPLING:	AC DC OFF		
	OFFSET: ¹	<NRx>		
	Volts/div	Offset Range	Resolution via RS-232-C, GPIB, or Numeric Entry	Step Size via front-panel Control knob
	1 mV to 99.5 mV 100 mV to 995 mV 1 V to 10 V	±1 V ±10 V ±100 V	25E-6 250E-6 2.5E-3	{ Coarse: 0.25 div. Fine: 0.025 div.
	BWHI:	<NRx> ≤24E6 >24E6 to ≤120E6 >120E6	HF Limit 20E6 100E6 350E6, 11301 400E6, 11302	
	IMPEDANCE:	<NRx>	Impedance 50	
	SENSITIVITY: ¹	Sensitivity 1E-3 to 1.99E-3 2E-3 to 4.98E-3 5E-3 to 9.95E-3 10E-3 to 19.9E-3 20E-3 to 49.8E-3 50E-3 to 99.5E-3 100E-3 to 199E-3 200E-3 to 498E-3 500E-3 to 995E-3 1 to 1.99 2 to 4.98 5 to 10	Resolution (step size) 10E-6 20E-6 50E-6 100E-6 200E-6 500E-6 1E-3 2E-3 5E-3 10E-3 20E-3 50E-3	
	UNITS:	<qstring> (query only) The 11A52 answers a units query with a units status message, which indicates the units of conversion of a probe connected to its Ch N input.		

¹ The numbers listed are valid only at the input connectors. Connecting an attenuating probe will change the value by the probe attenuating factor (e.g., a 10X probe will change the value ±10 to ±100).

Header	Link	Argument
CH<L1,L2,C1 C2, R1 or R2> (cont)	PROBE:	<qstring> (query only) This query-only link returns a quoted string indicating what type of probe is connected to the input. If a Level 1 TEKPROBE is connected, the query response is "Level 1." If a Level 2 TEKPROBE is connected, the query response is "Level 2/<probe_type>/<serial_number>." When neither Level 1 nor Level 2 TEKPROBE is connected, the query response is "NONE."

Legend:

CH<L1, L2, C1,
C2, R1 or R2>

L, C, and R mean Left, Center, and Right plug-in compartments; 1 and 2 mean Channel 1 and Channel 2, respectively.

COUPLING

Sets the specified channel input coupling.

OFFSET

Sets the specified channel offset.

BWHI

Sets the HF Limit (bandwidth) of the selected channel.

NRx

Numeric representation.

IMPEDANCE

Sets the input impedance of the specified channel.

SENSITIVITY

Sets the deflection factor of the specified channel. Sensitivity is a channel-specific command which does not apply to compound waveforms.

qstring

Quoted string data.

Part 3

Specification

Performance Conditions

The specifications that follow apply when the instrument is in the condition of Enhanced Accuracy. Enhanced Accuracy is obtained by performing an Enhanced Calibration in the specific host mainframe after the system has reached thermal equilibrium, which requires 20 minutes warmup. Enhanced Accuracy is indicated on the crt display and remains in effect as long as the mainframe internal temperature change is less than 5° C from the temperature at which the calibration was performed. When the 5° C change does occur the accuracy condition becomes Not-Enhanced. In the Not-Enhanced condition those Characteristics that are temperature sensitive may not remain within the limits of these specifications.

TABLE 3-1
Electrical Characteristics

Characteristic	Performance Requirement
----------------	-------------------------

DISPLAY

DEFLECTION FACTOR (Sensitivity)

Calibrated Range	1 mV to 10 V/div.
------------------	-------------------

Enhanced DC Accuracy¹, either polarity, any HF Limit of 11A52 in 11301/11302 Mainframes, with on-screen cursors.

Without Probes

Volts/Div	ΔV DC Acc.	DC Balance	DC Offset Acc.
1 mV to 99.5 mV	$\pm(1.0\% + 0.04\text{div})$	$\pm(0.20\text{mV} + 0.13\text{div})$	$\pm(0.15\% + 0.4\text{mV})$
100 mV to 995 mV	$\pm(1.0\% + 0.04\text{div})$	$\pm(2\text{mV} + 0.13\text{div})$	$\pm(0.20\% + 4\text{mV})$
1 V to 10 V	$\pm(1.0\% + 0.04\text{div})$	$\pm(20\text{mV} + 0.13\text{div})$	$\pm(0.20\% + 40\text{mV})$

With P6231 Probe calibrated from 11301/11302 Calibrator output

Volts/Div	ΔV DC Acc.	DC Balance	DC Offset Acc.
10 mV to 995 mV	$\pm(1.1\% + 0.04\text{div})$	$\pm(2\text{mV} + 0.13\text{div})$	$\pm(0.15\% + 2\text{mV})$
≥ 1 V	$\pm(1.2\% + 0.04\text{div})$	$\pm(20\text{mV} + 0.13\text{div})$	$\pm(0.15\% + 2\text{mV})$
Probe Tip TC term	100 ppm/° C		

¹ For absolute dc accuracy of single-point measurements using Offset, add the DC Offset Accuracy, DC Balance and ΔV DC Accuracy terms. Apply the ΔV DC Accuracy only to the difference between the Vertical Position setting and the measurement point.

TABLE 3-1 (cont)
Electrical Characteristics

Characteristic	Performance Requirement
DISPLAY (cont)	
DEFLECTION FACTOR (Sensitivity), cont.	
Coarse Resolution	1, 2, 5 sequence.
<p>Fine Resolution depends on Deflection Factor, as follows:</p> <p align="center">Rotating the Fine control one increment will change the Deflection Factor by 1% of the next more-sensitive Coarse setting.</p> <p align="center">For example, with deflection factor set to 198 mV, rotating the Fine control counterclockwise will cause this sequence of sensitivities: 199 mV, 200 mV, 202 mV, etc. Rotating the Fine control clockwise from 204 mV/div will cause the reverse sequence (202 mV, 200 mV, 199 mV, etc.).</p>	
OFFSET	
Accuracy	See Deflection Factor Accuracy, which precedes this characteristic.
Range, Resolution depend on Deflection Factor, as follows: between 1 mV and 99.5 mV/div.	±1 V. Coarse and fine resolution are 0.25 div. (250 μV) and 0.025 div. (25 μV), respectively.
between 0.1 V and 0.995 V/div.	±10 V. Coarse and fine resolution are 0.25 div. (2.5 mV) and 0.025 div. (250 μV), respectively.
between 1 V and ±10.0 V/div.	±100 V. Coarse and fine resolution are 0.25 div (25 mV) and 0.025 div (2.5 mV) respectively.

TABLE 3-1 (cont)
Electrical Characteristics

Characteristic	Performance Requirement	
DISPLAY (cont)		
FREQUENCY RESPONSE		
High Frequency Limit, (-3 dB point) and Calculated Rise Time of Display, Auxiliary, & Trig signals	Type of Mainframe	
	11301	11302
Volts/Division	11301	11302
≥10 mV	350 MHz 1.0 ns	400 MHz 0.9 ns
5 mV-9.95 mV	350 MHz 1.0 ns	400 MHz 0.9 ns
2 mV-4.98 mV	300 MHz 1.2 ns	300 MHz 1.2 ns
1 mV-1.99 mV	200 MHz 1.8 ns	250 MHz 1.4 ns
High Frequency -3 dB point		
100 MHz Limit	100 MHz ±30%.	
20 MHz Limit	20 MHz ±30%.	
Low Frequency -3 dB point, ac coupled Display, Trig, and Auxiliary signals	10 Hz maximum.	
STEP RESPONSE		
Overdrive Recovery Time		
1 mV to 99.5 mV/div. (for signals up to ±2 V peak)	<20 ns to within (0.1% of signal +0.2 division).	
100 mV to 995 mV/div. (for signals up to ±20 V peak)	<20 ns to within (0.1% of signal +0.2 division).	
1 V to 10 V/div. (for signals up to ±25 V peak)	<20 ns to within (0.1% of signal +0.2 division).	

TABLE 3-1 (cont)
Electrical Characteristics

Characteristic	Performance Requirement
INPUT CHARACTERISTICS	
Maximum Input Voltage, AC or DC Coupled,	5 Vrms (0.5 W) or 0.5 watt-second pulses not exceeding 25 V peak.
Maximum DC Input Voltage, AC Coupled	≤ 100 V (dc+peak ac). CAUTION <i>Signals of more than 25 V peak amplitude must be connected with the input coupling set to OFF so that the input coupling capacitor is precharged.</i>
Input Disconnect Threshold	5 Vrms minimum.
Power-Down Condition	50 Ω terminations disconnect when 11A52 is powered down.
Impedance (dc coupled)	50 Ω within 0.5%, VSWR < 1.25:1 from dc to 500 MHz.
Impedance (ac coupled)	50 Ω \pm 1% in series with at least 2.2 μ F, with 500 k Ω to ground. VSWR < 1.25:1 from 100 kHz to 500 MHz.
Input Bias Current	1.2 μ A maximum.

TABLE 3-1 (cont)
Electrical Characteristics

Characteristic	Performance Requirement
MISCELLANEOUS	
Typical Noise 1.0 mV to 1.99 mV/div 2.0 mV to 4.98 mV/div 5.0 mV to 9.95 mV/div 10.0 mV to 99.5 mV/div 100 mV to 995 mV/div 1.0 V to 10.0 V/div	0.08 div, rms. 0.04 div, rms. 0.02 div, rms. 0.012 div, rms. 0.012 div, rms. 0.012 div, rms.
DC Drift with Temperature	20 $\mu\text{V}/^\circ\text{C}$, or less, at any sensitivity. ¹
Channel Isolation	At least 50:1 display ratio ² , dc – 600 MHz.
Common Mode Rejection Ratio	At least 20:1, dc to 50 MHz, 10-div. reference signal on each input.
Probe Compatibility	The 11A52 is compatible with Level 1 and 2 TEKPROBES. ³

¹Dc drift can be calibrated out by invoking a calibration (Enhanced Accuracy) at any specific operating temperature.

$$^2\text{Display ratio} = \frac{\text{Amplitude (div)} \times \text{V/div (driven channel)}}{\text{Error amplitude (div)} \times \text{V/div (undriven channel)}}$$

³TEKPROBE is Tektronix' name for the interface used with probes designed for the 11000-Series of oscilloscopes and plug-in units. TEKPROBES have output connectors with one or more spring loaded coding pins. Two categories of TEKPROBES are:

Level 1

A level 1 probe uses analog encoding to indicate the probe's scale factor to the plug-in unit.

Level 2

A level 2 probe uses an EEPROM to store data about the the probe's transfer units, scale factor, and output voltage scale factor. Such data are serially encoded, then stored in the EEPROM. The probe data is intended to be read once at instrument power-up or when the probe is first connected to a plug-in unit (that is, at probe power-up).

TABLE 3-2
Environmental Characteristics

Characteristic	Information
Ambient temperature (External to main frame)	
Operating within specs.	0° to +50° C., mainframe ambient.
Nonoperating	-40° to +75° C.
Humidity, Operating and Nonoperating	Five days, per MIL-T-28800C, Type III, class 5 as described in 3.9.2.2 and 4.5.5.1.2.2.
Altitude	
Operating	To 4,570 m (15,000 ft.).
Nonoperating	To 15,200 m (50,000 ft.).
Vibration	
Operating, installed on Flexible Extender	MIL-T-28800C, Sec. 4.5.5.3.1, type III, class 5.
Shock, Nonoperating (not installed in mainframe)	MIL-T-28800C, Sec. 4.5.5.4.1, type III, class 5.
Bench Handling (operating and nonoperating)	MIL-T-28800C, Sec. 4.5.5.4.3, type III, class 5.
Packaged Product Vibration and Shock	
Vibration and Bounce of Packaged Product	Meets ASTM D999-75, Method A (NSTA Project 1A-B-1).
Drop of Packaged Product	Meets ASTM D775-61, Paragraph 5 (NSTA Project 1A-B-2).
Electromagnetic Compatibility	MIL. STD. 461B. FCC Part 15, Subpart J, Class A. VDE 0871/6.78, Class B.

Table 3-3
Physical Characteristics

Characteristic	Information
Weight (max)	1 lb. 14 oz. (851 grams).
Weight of Packaged Product (max)	4 lb. 12 oz. (2.2 kg).
Dimensions (max)	Refer to Figure 3-1.

Recommended Probes

Tektronix recommends the P6231 Probe for use with the 11A52. It has the following characteristics:

P6231 Low Impedance Subminiature 10X Active Probe. The P6231 has a bandwidth of 1.5 GHz, input impedance of 450 Ω , and dc offset of ± 5 V controlled by the 11A52. The P6231 is a Level 2 probe.

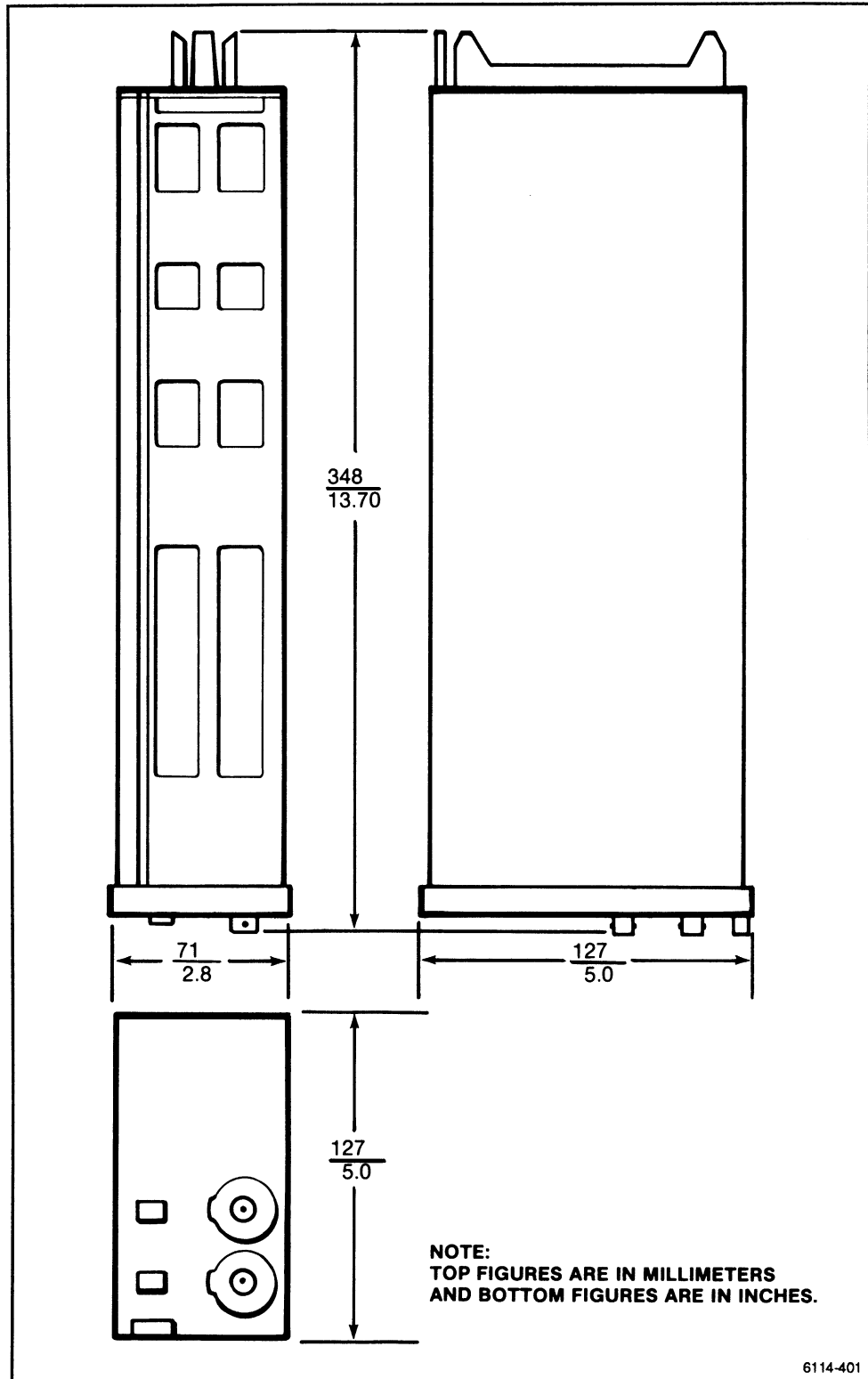
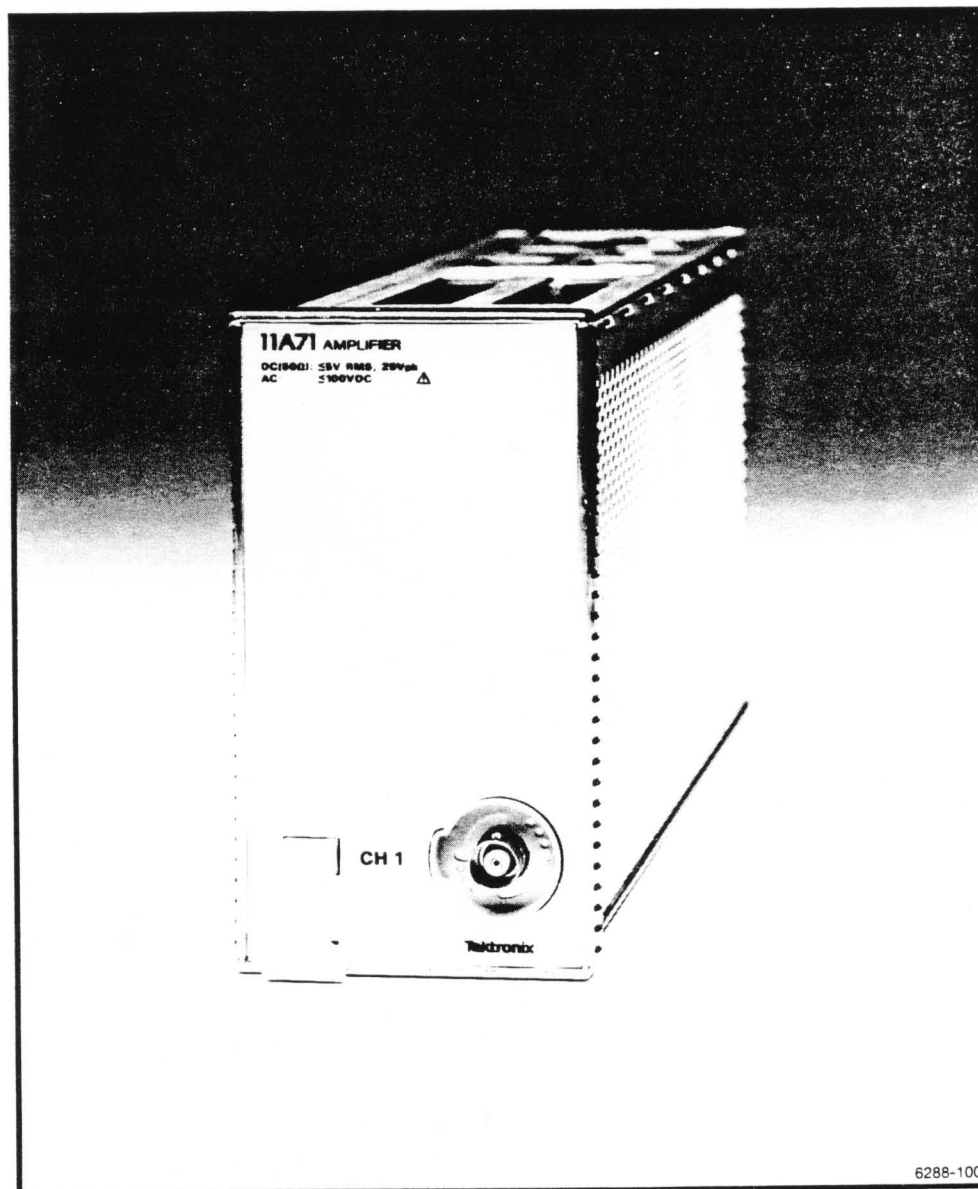

Figure 3-1. Dimensions of 11A52.

Appendix A—Glossary

Deflection factor	The ratio of input signal to response in the 11000 system. The reciprocal of sensitivity.
Display on/off button	The front-panel, plug-in button that designates a channel for display, or removes a channel from the display.
Mainframe	Any 11000-series oscilloscope exclusive of plug-in units.
Offset	A control that allows the user to subtract a precision voltage from the input signal to vary the position of the displayed signal.
ON/STANDBY	The front-panel power control on 11000-series mainframes. When set to ON, applies operating power to all circuits. When set to STANDBY, the mainframe dc power supply supplies power to the counter-timer crystal oven (Option 1T).
Overdrive	A condition in which amplifiers are driven into a non-linear operating range. Typically many divisions off screen.
Overload	The condition existing when a potentially damaging voltage is applied to the input connector.
Toggle	To switch alternately between two functions (e.g., on and off).

11A71 Amplifier



11A71 Features and Functions

Features

- Up to 1000 MHz bandwidth (in 11402)
- Single trace
- Calibrated sensitivities from 10 mV to 1 V/division
- 50 Ω input impedance
- Calibrated DC offset (0.25 division/increment, coarse; 0.025 division/increment, fine)

Functions

Signals applied to the CH 1 input connector can be displayed or removed from the display by pressing the display on/off button adjacent to the input connector.

All other 11A71 functions are controlled through the host mainframe. Such mainframe-controlled functions are:

- Sensitivity over a range of 10 mV to 1 V/division in a 1,2,5 sequence.
- Vertical Offset over a range of ± 10 divisions.
- Coupling: Ac, Dc, or Off.

Contents

Part 1—General Information

Technical Manuals.....	1-1
Contents of this Supplement.....	1-1
11A71 Service Manual.....	1-2
Plug-in to Mainframe Compatibility.....	1-2
Initial Inspection.....	1-2
Operating Temperature.....	1-3
Installing and Removing the 11A71.....	1-3
Instrument Options.....	1-4
Packaging for Shipment.....	1-5

Part 2—Operating the 11A71 in 11301 and 11302 Mainframes

Display On/Off.....	2-1
Selecting Coupling.....	2-1
Other Functions.....	2-2
Position and Offset.....	2-2
DC Circuit Loading.....	2-3
Adding and Subtracting Waveforms.....	2-4
50 Ω Overload.....	2-5
Active Probes.....	2-5
Probe ID.....	2-5
Front-Panel Error Messages.....	2-6
GPIB and RS-232-C Commands and Syntax.....	2-7

Part 3—Specification

Performance Conditions.....	3-1
Electrical Characteristics.....	3-1
Environmental Characteristics.....	3-5
Physical Characteristics.....	3-6
Recommended Probes.....	3-6

Appendix A—Glossary.....	A-1
---------------------------------	------------

Illustrations

1-1	Installing a plug-in unit in a mainframe oscilloscope.....	1-4
2-1	Location of AC coupling capacitors in plug-in amplifiers.....	2-3
3-1	Dimensions of 11A71.....	3-7

Tables

2-1	Functions And Where They Are Described.....	2-2
3-1	Electrical Characteristics.....	3-1
3-2	Environmental Characteristics.....	3-5
3-3	Physical Characteristics.....	3-6

Part 1

General Information

Technical Manuals

This Supplement to the User's Reference manual is a standard accessory to the 11A71. An 11A71 Service manual is also available.

Contents of this Supplement

This Supplement contains the following three parts:

Part 1—GENERAL INFORMATION, describes mainframe to plug-in unit compatibility, explains how to install and remove the 11A71 from a mainframe, outlines any options available for the 11A71, and gives details about packaging for shipment.

Most 11A71 functions, and how they are operated, are described in the Operating Information section of the mainframe User's Reference manuals. Such functions are those that are common to all amplifier plug-in units. Examples of common functions are position, sensitivity, and coupling. Only those functions unique to the 11A71-11301/11302 combination are explained in the following parts.

Part 2—OPERATING THE 11A71 IN 11301 AND 11302 MAINFRAMES, explains how to operate those 11A71 functions not covered in the 11301 and 11302 User's Reference manual.

Part 3—SPECIFICATION, gives detailed specifications of all 11A71-mainframe oscilloscope combinations.

11A71 Service Manual

WARNING

The 11A71 Service manual is for use by qualified service personnel only. To avoid personal injury, do not perform any service other than that contained in the Operator's manuals unless you are qualified to do so. Refer to the Operators Safety Summary and Service Safety Summary before performing any service.

The 11A71 Service manual contains the following information:

Section 1—GENERAL INFORMATION.

Section 2—THEORY OF OPERATION.

Section 3—MAINTENANCE.

Section 4—CHECKS AND ADJUSTMENT.

Section 5—INSTRUMENT OPTIONS.

Section 6—REPLACEABLE ELECTRICAL PARTS.

Section 7—DIAGRAMS AND CIRCUIT BOARD ILLUSTRATIONS.

Section 8—REPLACEABLE MECHANICAL PARTS.

Plug-in to Mainframe Compatibility

The 11A71 is designed for use in the 11301, 11302, 11401, and 11402 and future 11000-series plug-in mainframes. 11A71 bandwidth varies depending on its host mainframe. Details about bandwidth are included in Part 3, Specification, of this subsection, and in the Tektronix Corporate Catalog. Refer to the Tektronix Corporate Catalog for complete compatibility information.

Initial Inspection

This instrument was inspected mechanically and electrically before shipment. It should be free of marks or scratches and should meet all electrical specifications. To confirm this, inspect the 11A71 for physical damage incurred in transit. Instrument performance may be verified by using the procedure given in Part 5, Incoming Inspection and Performance Verification, in the 11A71 User's Reference Supplement, Tektronix Part 070-6288-00. If you find damage or deficiency, contact your local Tektronix Field Office or representative.

Operating Temperature

The 11A71 can be operated where the ambient air temperature is between 0° C and +50° C and can be stored in ambient temperatures from -40° C to +75° C. After storage at temperatures outside the operating limits, allow the chassis to reach operating temperature limits before applying power.

Installing and Removing the 11A71



To avoid instrument damage, set the mainframe ON/STANDBY switch to STANDBY before installing or removing the 11A71.

When installed in the 11301/11302 mainframe left or center plug-in compartment, the 11A71 will provide a conventional display.

When installed in the center or right plug-in compartment of the 11301/11302 mainframe, the 11A71 will also provide the X part of an X-Y display, or provide a trigger signal for the mainframe time base.

To install the 11A71 in any 11000-series plug-in oscilloscope mainframe, set the mainframe ON/STANDBY switch to STANDBY. Align the grooves in the top and bottom of the 11A71 with the guides in the mainframe plug-in compartment, then insert the 11A71 into the mainframe until its front panel is flush with the front panel of the mainframe.

To remove the 11A71 from a mainframe, set the mainframe ON/STANDBY switch to STANDBY. Then pull the release latch (see Fig. 1-1) to disengage the unit from the mainframe, and pull the 11A71 straight out of the plug-in compartment.

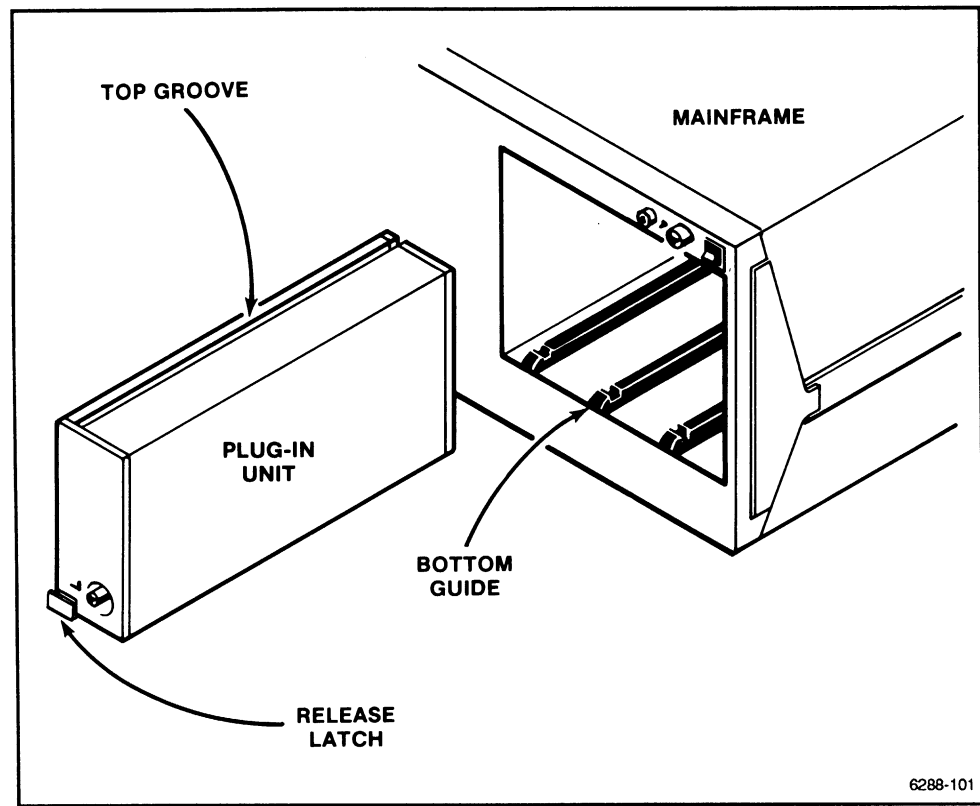

Figure 1-1. Installing a plug-in unit in a mainframe oscilloscope.

Instrument Options

Option 26 includes one P6231 probe.

Packaging for Shipment

If this instrument is to be shipped by commercial transportation, we recommend that it be packaged in the original manner. The original carton and packaging material can be saved and reused for this purpose.

NOTE

Package and ship plug-in units and mainframes separately.

If the 11A71 is to be shipped to a Tektronix Service Center for service or repair, attach a tag to the instrument. On the tag, include the following information:

- Name and address of the instrument owner;
- Name of a person at your firm who can be contacted about the instrument;
- Complete instrument type and serial number; and
- A description of the service required.

If the original package is not available or is not fit for use, package the 11A71 as follows:

1. Obtain a corrugated cardboard carton with inside dimensions at least six inches greater than the instrument dimension. Use a carton with a test strength of at least 200 pounds.
2. Fully wrap the 11A71 with anti-static sheeting, or its equivalent, to protect its finish.
3. Cushion the 11A71 on all sides by tightly packing dunnage or urethane foam between the carton and the instrument. Allow three inches of packing on each side.
4. Seal the carton with shipping tape or with industrial staples.
5. Mark the address of the Tektronix Service Center and your return address on the carton in one or more prominent places.

Part 2

Operating the 11A71 in 11301 and 11302 Mainframes

Display On/Off

The 11A71 has only one front-panel control—the display on/off button. Pressing the display on/off button will cause Channel 1, and its signal, to be displayed or removed from the display. When Channel 1 is used for display, its label (CH 1) will be illuminated.

Selecting Coupling

To select a setting for Coupling, proceed as follows:

- 1a. If no trace is displayed, press the plug-in display on/off button to create a trace.
- 1b. If several traces are displayed, select one by touching its trace description at the top of the crt.
2. Press any VERTICAL button—OFFSET, SIZE, or POSition. This button-press will cause the Control Menu to be displayed.
3. Touch the coupling label. Successive touches will change its state.

Other Functions

Other 11A71 functions are controlled within the 11301 or 11302 mainframe, and their operation is described in detail in Section 2, Operating Information, of the 11301 and 11302 User's Reference Manual. Table 2-1 shows where to find information about operating the 11A71.

TABLE 2-1
Functions And Where They Are Described

Function	Described Under Heading
Offset Size (V/div)	Waveform Acquisition: Vertical Menu. for X-Y Display: Horizontal Menu.
Display Select Ch 1	Waveform Acquisition: Vertical Menu. for X-Y Display: Horizontal Menu.
Trigger Selection	Trigger Source Major Menu.

Position and Offset

The 11301 and 11302 oscilloscopes assign position control to the Left Control knob by pressing the VERTICAL POS button. The Vertical Position control moves the trace. For example, when displaying multiple channels it may be desirable to set ground references for each trace on separate graticule lines. Position is a screen-related function; its units are divisions.

The offset function, accessed by pressing the VERTICAL OFFSET button, subtracts a precision voltage from the input signal. Changing offset moves the trace just as does the position control.

Changing the sensitivity (size) will cause the display to magnify or demagnify around some screen location (e.g., two divisions above graticule center) set by the Position control. The Offset control is used to return the waveform area of interest, which is magnified or demagnified, to the location originally established by the Position control.

The Position control has a range of plus and minus four divisions from graticule center, while the Offset control has a range of plus and minus 10 divisions.

DC Circuit Loading

AC coupling capacitors are connected differently in the 11A52 and 11A71 than in the 11A32 and 11A34. Figure 2-1 shows this difference.

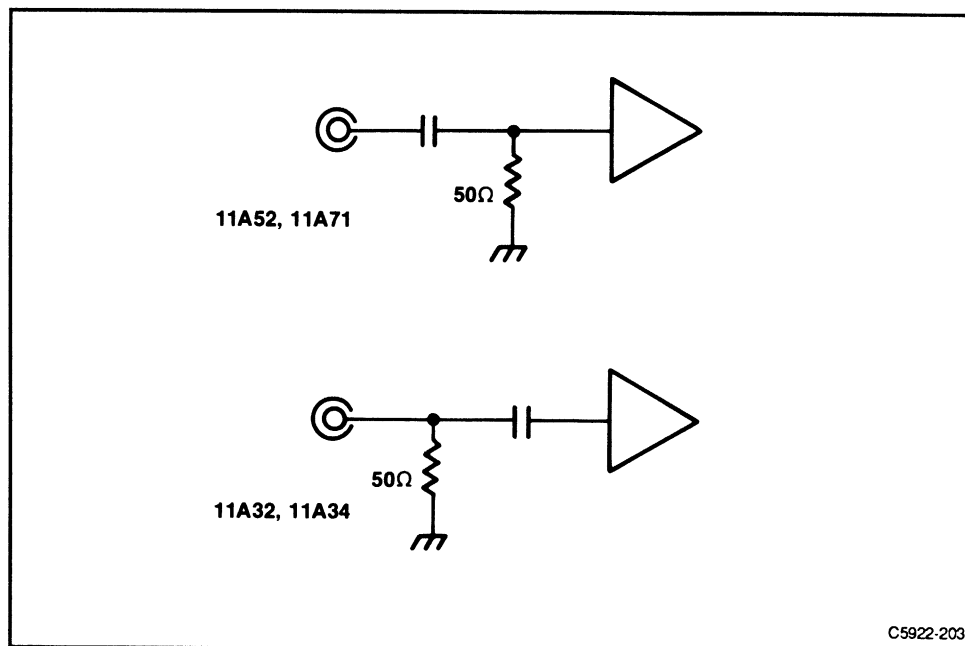

Figure 2-1. Location of AC coupling capacitors in plug-in amplifiers.

In the 11A52 and 11A71, the coupling capacitor isolates both the input termination and the amplifier from external dc voltages. Avoid inadvertently selecting Dc Coupling if your circuit will be damaged by the resulting 50Ω termination to ground. See Caution below. The coupling capacitor in the 11A32 and 11A34 does not isolate the input termination from external dc voltages.

When Ac Coupling is selected, the 11A71 coupling capacitor allows the user to test low-impedance circuits that are elevated in potential by up to 100 volts dc without loading the circuit at dc. Passive attenuating probes such as the P6056 or P6057 eliminate the dc loading and lower the low-frequency -3 dB point.

In the Off coupling mode the ac coupling capacitor precharges in about three seconds to the average dc voltage of the circuit being tested. Always use the Off mode when connecting the 11A71 input to a circuit that may have more than 25 volts (the 11A71 peak input voltage rating) present. This will precharge the coupling capacitor. Wait a few seconds before selecting Ac Coupling.

The coupling capacitor is discharged upon removal of the external circuit.

CAUTION

Always use caution when working with voltages in excess of 25 volts.

When the input coupling is set to Dc, a 50 Ω termination resistance is connected directly from the 11A71 input connector to ground. Take care that the circuit connected to the 11A71 input will not be damaged by the 50 Ω load.

Two ways of unintentionally invoking Dc Coupling in the 11A71 are:

- 1. Invoking Autoset, because the Autoset process starts by searching for a dc voltage, and*
- 2. Recalling a stored control setting that dictates Dc Coupling.*

Switching coupling to Dc when more than 25 V is present at the 11A71 input will exceed the peak input voltage specification, and may damage the 11A71 input relay. A damaged relay could cause an error in calibration.

Adding and Subtracting Waveforms

NOTE

Before adding or subtracting waveforms, check that each channel's display is independently on screen.

The 11301 and 11302 allow the addition or subtraction of any two channels. Two channels within one plug-in unit may be added, or one channel may be added to a channel from another plug-in unit. A simple restriction applies. Each channel must be in its linear operating range. This is assured if each channel separately is within the screen area before addition or subtraction.

Those portions of a trace which are off screen will not be valid when brought back on screen using another channel's input signal or Offset control. This general restriction applies to any dual-channel oscilloscope.

50Ω Overload

When the input voltage exceeds approximately 5 Vrms, the 11A71 will sense the overload, disconnect the 50Ω input termination and set input Coupling to Off. The mainframe will display the following message: "Input channel 1 overload on LEFT/CENTER/RIGHT plugin."

To reconnect the 50Ω input termination, first correct the overload condition, then select Ac or Dc from the Coupling menu.

Active Probes

Using an active probe, such as the P6231, eliminates the possibility of Ac Coupling. Coupling options available when using such a probe are Off and Dc.

Probe ID

The Probe ID part of the Utility Menu is the means of selecting how the 11301 or 11302 responds to an ID button-push of recommended probes. All, or some combination of the following operations may be set to start in response to probe ID buttons. To display the Utility Menu, press the front-panel UTILITY button. For details, see the Probe ID part of the Waveform Acquisition subsection in the 11301 and 11302 User's Reference manual.

Pressing the probe ID button can initiate one or more of the following operations:

1. **Present a new display, or if that channel is already displayed, "select" the existing trace.** Pressing the ID button of a probe connected to an undisplayed left or center compartment channel will cause that channel to be displayed, unless doing so would exceed the maximum number of traces. Unlike the 11A71 display on/off button, pressing the probe ID button a second time will not remove the display. Probe ID button-presses for displayed channels will do two things: a) select the trace(s) using this channel, and b) momentarily brighten all traces using this channel.
2. **Stored settings can be sequentially recalled.** Pressing the probe ID button can cause a sequential recall of stored settings. The stored settings feature must be enabled using the Probe ID Utility menu. Settings must be stored as explained under STORE/RECALL Major Menu in the 11301 and 11302 User's Reference manual.

3. **The mainframe can "Autoset" to accommodate the input signal introduced by the probe.** The Autoset feature can be enabled or disabled using the Probe ID Utility menu. Autoset is automatic setup of vertical deflection factor, triggering, and sweep speed to produce a meaningful display, e.g., two to five divisions of vertical deflection and two to five repetitions of the input signal. For more information, refer to Autoset in the 11301 and 11302 User's Reference manual.
4. **The mainframe can automatically measure the selected trace.** Automatic measurements of the selected trace can be initiated by pressing a probe ID button. The Automatic Measurements feature can be enabled or disabled using the Probe ID Utility menu. Such measurements are peak-to-peak, maximum, middle, and minimum voltages; frequency, period, pulse width, and duty cycle. For full information about automatic measurements, see Measure in the 11301 and 11302 User's Reference manual.
5. **An interrupt to the GPIB and RS-232-C can be generated.** Pressing a probe ID button will cause the mainframe to produce an SRQ to the GPIB and RS-232-C. For more information, refer to the GPIB/RS-232-C part of the 11301 and 11302 User's Reference manual.

Front-Panel Error Messages

- Message:** Internal DAC overflow on channel 1 of LEFT, CENTER, or RIGHT plug-in unit.
- Cause:** Some plug-in unit detected that a requested setting overflowed an internal DAC. Such overflow usually indicates defective hardware. In this situation, the plug-in unit sets the DAC to the limit nearer the requested setting.
- Message:** Bad Level 2 probe checksum on channel 1 of LEFT, CENTER, or RIGHT plug-in unit.
- Cause:** Some plug-in unit detected that a Level 2 TEKPROBE had failed or been improperly connected.

GPIB and RS-232-C Commands and Syntax

The following commands set parameters of a specified channel.

Header	Link	Argument		
CH<L1, C1, or R1>	COUPLING:	AC DC OFF		
	OFFSET: ¹	<NRx>		
	Volts/div	Offset Range	Resolution via RS-232-C, GPIB, or Numeric Entry	Step Size via front-panel Control knob
	10 mV 20 mV 50 mV 100 mV 200 mV 500 mV 1 V	±100 mV ±200 mV ±500 mV ±1 V ±2 V ±5 V ±10 V	250E-6 500E-6 1.25E-3 2.5E-3 5.0E-3 12.5E-3 25E-3	{ Coarse: 0.25 div. Fine: 0.025 div.
	IMPEDANCE:	<NRx>	Impedance 50	
	BWHI:	<NRx>	Bandwidth 400E6, 11301 500E6, 11302	
	SENSITIVITY: ¹	Sensitivity 10E-3 20E-3 50E-3 100E-3 200E-3 500E-3 1		
UNITS:	<qstring> (query only) The 11A71 answers a Units query with a units status message, which indicates the units of conversion of a probe connected to its Ch 1 input.			

¹The numbers listed are valid only at the input connector. Connecting an attenuating probe will change the value by the probe attenuating factor (e.g., a 10X probe will change the value ±10 to ±100).

Header	Link	Argument
CH<L1,C1, or R1> (cont)	PROBE:	<qstring> (query only) This query-only link returns a quoted string indicating what type of probe is connected to the input. If a Level 1 TEKPROBE is connected, the query response is "Level 1." If a Level 2 TEKPROBE is connected, the query response is "Level 2/<probe_type>/<serial_number>." When neither Level 1 nor 2 TEKPROBE is connected, the query response is "NONE."

Legend:

CH<L1, C1, and R1>	L, C, and R mean Left, Center, and Right plug-in compartments; 1 means Channel 1.
COUPLING	Sets the specified channel input coupling.
BWHI	Sets the HF Limit (bandwidth) of the specified channel.
OFFSET	Sets the specified channel offset.
IMPEDANCE	Sets the deflection factor of the specified channel.
SENSITIVITY	Sets the deflection factor of the specified channel. Sensitivity is a channel-specific command which does not apply to compound waveforms.
qstring	Quoted string data.

Part 3

Specification

Performance Conditions

The specifications that follow apply when the instrument is in the condition of Enhanced Accuracy. Enhanced Accuracy is obtained by performing an Enhanced Calibration in the specific host mainframe after the system has reached thermal equilibrium, which requires 20 minutes warmup. Enhanced Accuracy is indicated on the crt display and remains in effect as long as the mainframe internal temperature change is less than 5° C from the temperature at which the calibration was performed. When the 5° C change does occur the accuracy condition becomes Not-Enhanced. In the Not-Enhanced condition those Characteristics that are temperature sensitive may not remain within the limits of these specifications.

TABLE 3-1
Electrical Characteristics

Characteristic	Performance Requirement		
DISPLAY			
DEFLECTION FACTOR (Sensitivity)			
Calibrated Range	10 mV to 1.0 V/div. in seven steps in a 1,2,5 sequence.		
Enhanced DC Accuracy ¹ , of 11A71 in 11301/11302 Mainframes, of On-screen Cursors Readings with Position set to 0.00.			
Without Probes			
Volts/Div	ΔV DC Acc.	DC Balance	DC Offset Acc.
10 mV to 1V	$\pm(0.9\% + 0.05\text{div})$	$\pm(0.2\text{div})$	$\pm(0.20\% + 0.01\text{mV})$
With P6231 Probe calibrated from 11301/11302 Calibrator output			
Volts/Div	ΔV DC Acc.	DC Balance	DC Offset Acc.
100 mV to 1V	$\pm(1.6\% + 0.05\text{div})$	$\pm(0.2\text{div})$	$\pm(0.15\% + 2\text{mV})$
Probe Tip TC term	100 ppm/°C		

¹For absolute dc accuracy of single-point measurements using Offset, add the DC Offset Accuracy, DC Balance and ΔV DC Accuracy terms. Apply the ΔV DC Accuracy only to the difference between the Vertical Position setting of 0.0 and the measurement point.

TABLE 3-1 (cont)
Electrical Characteristics

Characteristic	Performance Requirement	
DISPLAY (cont)		
DEFLECTION FACTOR (Sensitivity), cont.		
Coarse Resolution	1, 2, 5 sequence.	
OFFSET		
Accuracy	See Deflection Factor Accuracy, which precedes this characteristic.	
Range, Resolution	±10 div. Coarse and fine resolution are 0.25 and 0.025 div., respectively.	
FREQUENCY RESPONSE		
High Frequency Limit (-3 dB point) of Display and Calculated Rise Time, +20° to +30° C	Type of Mainframe	
	Volts/Division	11302
	All	500 MHz 0.7 ns
Low Frequency -3 dB point, ac coupled Display and Trigger signals	1 kHz or less from 50 Ω source.	

TABLE 3-1 (cont)
Electrical Characteristics

Characteristic	Performance Requirement
INPUT CHARACTERISTICS	
Maximum Input Voltage, AC or DC Coupled,	5 Vrms (0.5 W) or 0.5 watt-second pulses not exceeding 25 V peak.
Maximum DC Input Voltage, AC Coupled	≤ 100 V (dc+peak ac). CAUTION <i>Signals of more than 25V peak amplitude must be connected with the input coupling set to OFF so that the input coupling capacitor is precharged.</i>
Input Disconnect Threshold	+5 Vdc \pm 1 V, -5 Vdc \pm 1 V, 5 Vrms up to 100 MHz.
Input Protection Disconnect Time	30 ms or less for 25 Vdc or either polarity. 40 ms to 150 ms for 12.5 Vdc of either polarity.
Power-Down Condition	50 Ω termination disconnects when 11A71 is powered down.
Impedance (dc coupled)	50 Ω within 2%. VSWR <1.45:1 at 10 mV/div., dc to 1 GHz; VSWR <1.25:1 at 20 mV to 1 V/div., dc to 1 GHz.
Impedance (ac coupled)	50 Ω within 2% in series with at least 2.2 μ F. VSWR \leq 1.45:1 at 10 mV/div., dc to 1 GHz; VSWR \leq 1.25:1 at 20 mV to 1 V/div., dc to 1 GHz.
Reflection Coefficient	$\pm 10\%$ or less, total not to exceed 20% pk-pk in a 1 GHz time-domain reflectometer system.
Input Bias Current	50 μ A or less.

TABLE 3-1 (cont)
Electrical Characteristics

Characteristic	Performance Requirement
MISCELLANEOUS	
Probe Compatibility	The 11A71 is compatible with Level 1 and Level 2 TEKPROBES. ¹

¹TEKPROBE is Tektronix' name for the interface used with probes designed for the 11000-series of oscilloscopes and plug-in units. TEKPROBES have output connectors with one or more spring-loaded coding pins. Two categories of TEKPROBES are:

Level 1

A level 1 probe uses analog encoding to indicate the probe's scale factor to the plug-in unit.

Level 2

A level 2 probe uses an EEPROM to store data about the probe's transfer units, scale factor, and output voltage scale factor. Such data are serially encoded, then stored in the EEPROM. The probe data is intended to be read once at instrument power-up or when the probe is first connected to a plug-in unit (that is, at probe power-up).

TABLE 3-2
Environmental Characteristics

Characteristic	Information
Ambient temperature (External to main frame)	
Operating within specs.	0° to 50°C., mainframe ambient.
Nonoperating	-40° to +75° C.
Humidity, Operating and Nonoperating	Five days, per MIL-T-28800C. Type III, class 5 as described in 3.9.2.2 and 4.5.5.1.2.2.
Altitude	
Operating	To 4,570 m (15,000 ft.).
Nonoperating	To 15,200 m (50,000 ft.).
Vibration	
Operating, installed on Flexible Extender	MIL-T-28800C, Sec. 4.5.5.3.1, type III, class 5.
Shock, Nonoperating (not installed in mainframe)	MIL-T-28800C, Sec. 4.5.5.4.1, type III, class 5.
Bench Handling (operating, and nonoperating)	MIL-T-28800C, Sec. 4.5.5.4.3 type III, class 5.
Packaged Product Vibration and Shock	
Vibration and Bounce of Packaged Product	Meets ASTM D999-75, Method A Paragraph 3.1 (NSTA Project 1A-B-1).
Drop of Packaged Product	Meets ASTM D775-61, Method 1 Paragraph 5 (NSTA Project 1A-B-2).
Electromagnetic Compatibility	MIL. STD. 461B. FCC Part 15, Subpart J, Class A. VDE 0871/6.78, Class B.

Table 3-3
Physical Characteristics

Characteristic	Information
Weight (max)	2 lb. 0 oz. (908 grams)
Weight of Packaged Product (max)	4 lbs. 14 oz. (2213 grams)
Dimensions (max)	Refer to Figure 3-1.

Recommended Probes

Tektronix recommends the P6231 Probe for use with the 11A71. It has the following characteristics:

P6231 Low Impedance Subminiature 10X Active Probe. The P6231 has a bandwidth of 1.5 GHz, input impedance of 450 Ω , and dc offset of ± 5 V controlled by the plug-in unit. The P6231 is a Level 2 probe.

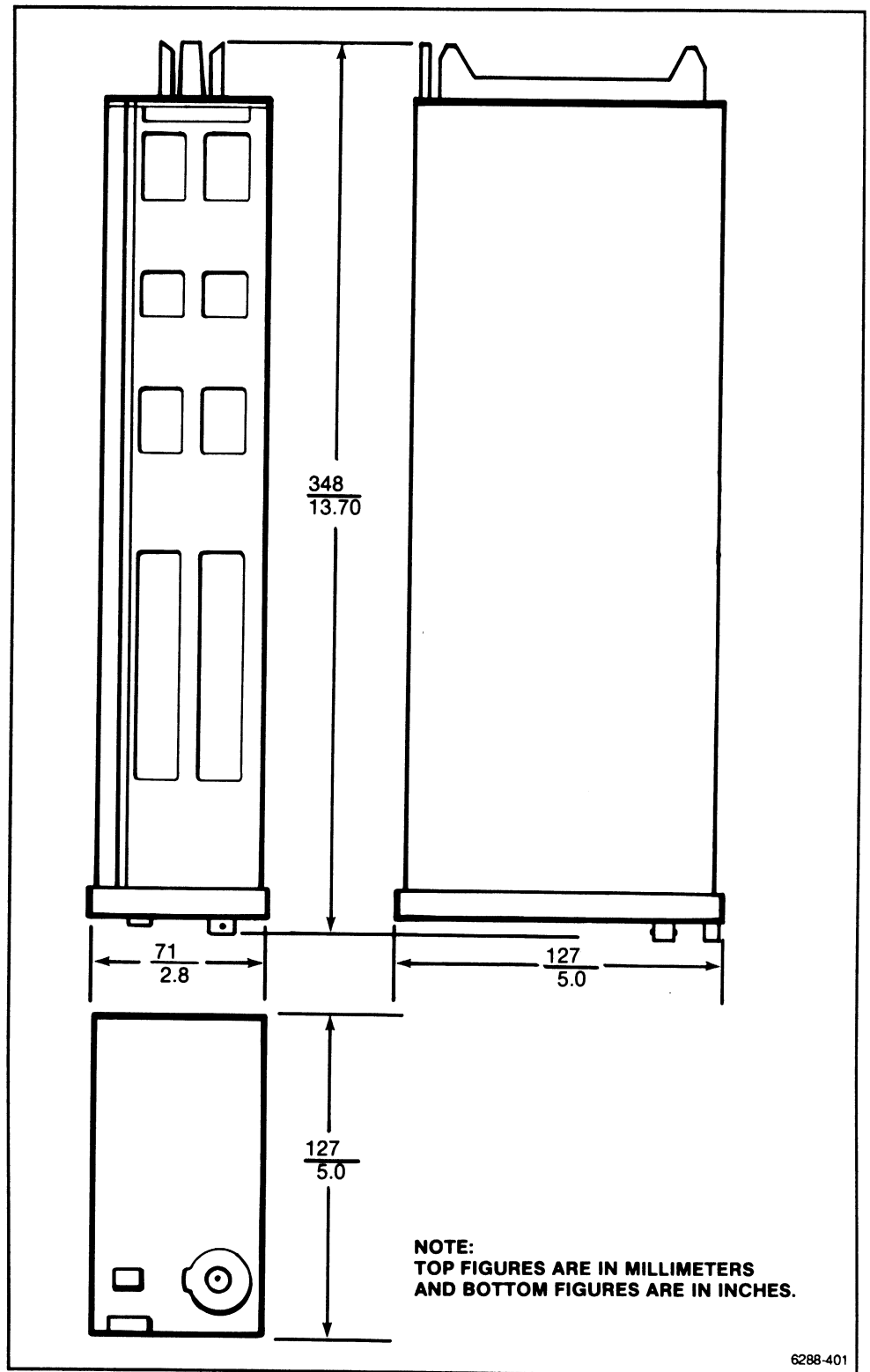

Figure 3-1. Dimensions of 11A71.

Appendices

Appendix A—Glossary

Deflection factor	The ratio of input signal to response in the 11000 system. The reciprocal of sensitivity.
Display on/off button	The front-panel plug-in unit button that designates the channel for display, or removes it from the display.
Mainframe	Any 11000-series oscilloscope exclusive of plug-in units.
Offset	A control that allows the user to subtract a precision voltage from the input signal to vary the position of the displayed signal.
ON/STANDBY	The front-panel power control on 11000-series mainframes. When set to ON, applies operating power to all circuits. When set to STANDBY, the mainframe dc power supply supplies power to the counter-timer crystal oven (Option 1T).
Overdrive	A condition in which amplifiers are driven into a non-linear operating range. Typically many divisions off screen.
Overload	The condition existing when a potentially damaging voltage is applied to the input connector.
Toggle	To switch alternately between two functions (e.g., on and off).

Appendix A—Glossary

D1 (or 2)	An alternate abbreviation for Dly1 (or 2) used in the trace descriptions.
Deflection factor	The ratio of input signal to response in the 11000-Series system. The reciprocal of sensitivity.
Display on/off button	The front-panel plug-in button that designates a channel for display, or removes a channel from the display.
Dly1 (or 2)	Indicates the delay reference number one (or two) and window number one (or two).
Duty	The duty factor of the signal is a percent of its period; $Duty = 100 (Wid/Per)$.
Freq	The fundamental frequency of the signal as measured by its crossing the reference level.
Main	An abbreviation for Main time base.
Mainframe	Any 11000-Series oscilloscope.
Max	The most positive amplitude value; its maximum.
Mid	The middle value; halfway between the maximum and the minimum value of the signal. That is, the time between the first positive slope and first following negative slope of the signal; pulse width.
Min	The most negative amplitude value; its minimum.
Offset	A control that allows the you to subtract a precision voltage from the input signal to vary the position of the displayed signal.
ON/STANDBY	The front-panel power control on 11000-series mainframes. When set to ON, applies operating power to all circuits. When set to STANDBY, the mainframe dc power supply furnishes power to the counter/timer crystal oven (Option 1T).
P-P	Peak-to-peak amplitude as given by the difference from the minimum value of the signal to its maximum value.
Parent Trace	The main trace from which a window is derived.
Per	The inverse of frequency: $Per (period) = 1/Freq$.
Sensitivity	The ratio of response to input signal in the 11000-Series system. In the 11A32, 11A34, 11A52, and 11A71, division/volts. Also called size, vertical size, and deflection factor in this manual.
Size	See Sensitivity.
Wid	The time between the first positive slope and the first following negative slope of the signal; pulse width.

Appendix B—Accessory List

Standard Accessories

The following standard accessories are included in each instrument package. To obtain replacements, refer to a Tektronix Products catalog or contact your local Tektronix Field Representative.

- Introducing the 11301 and 11302 Programmable Oscilloscopes
- 11301 and 11302 Programmable Oscilloscopes Pocket Reference manual
- 11301 and 11302 Programmable Oscilloscopes User's Reference manual
- Power Cord (North American 125 V)

Optional Accessories

These optional accessories have been selected from our catalog specifically for your instrument. They are listed as a convenience to help you meet your measurement needs. For detailed information and prices, refer to a Tektronix Products catalog or contact your local Tektronix Field Representative.

- 11301 Service Manuals:
 - Service Volume 1—Maintenance
 - Service Volume 2—Diagnostics & Troubleshooting
 - Service Volume 3—Schematics & Parts List
- 11302 Service Manuals:
 - Service Volume 1—Maintenance
 - Service Volume 2—Diagnostics & Troubleshooting
 - Service Volume 3—Schematics & Parts List
- Blank Plug-in Unit (for empty plug-in compartment)
- 2 meter GPIB cable
- 10 foot RS-232-C cable

Recommended Accessories

The accessories listed here are additions you may wish to use with your oscilloscope. For detailed information and prices, refer to a Tektronix Products catalog or contact your local Tektronix Field Representative.

- **Cameras**—C-4, C-5C, C-7, C-51¹, C-53¹, C-59¹
- **Viewing Hoods**—Nonfolding and Folding
- **Scope Cart**—Model 205
- **Probes**—P6134, P6135, P6231, P6204

NOTE: Also refer to Section 5, "Instrument Options."

¹Require Option 11 adapter lens.

Errors, Warnings, and Messages

Error and Warning Messages

Remote Interfaces (event code)	Displayed on Screen	Message and Probable Cause
108	no	Checksum error in binary block transfer
109	no	Incorrect byte count value on a binary block transfer
151	no	Symbol of number too long
152	no	Invalid of out-of-range input character
153	no	Invalid escape sequence
154	no	Invalid number input
155	no	Invalid string input
156	no	Unknown symbol
157	no	Syntax error An unexpected symbol or character was detected in an input statement, usually caused by missing delimiter or misspelled command.
160	no	Expression too complex
161	no	Too many binary points
162	no	Too many ASCII points
165	no	Numerical overflow A number was received which was too large to express in IEEE double-precision format.
166	no	Numerical underflow A number was received which was too small to express in IEEE double-precision format.
167	no	Function not available to External Port
168	yes	Incomplete trigger expression, aborted
203	no	I/O buffers full, output flushed Input and output are deadlocked.
205	no	Argument is not executable A value was received which could not be used for the requested setting. Rather than choosing the nearest setting, the oscilloscope ignored it.

Remote Interfaces (event code)	Displayed on Screen	Message and Probable Cause
206	yes	Signal amplitude too small The Autoset process could not find sufficient amplifier sensitivity to display the signal properly.
207	yes	Signal amplitude too large The Autoset process could not decrease the amplifier sensitivity to display the signal properly.
208	yes	Vertical signal not found The Autoset process could not find any triggerable signal.
209	yes	Horizontal signal not found The Autoset process could not measure the timing characteristics of the signal.
210	yes	Cannot autoset, trace not available Autoset was requested for a trace which does not exist.
211	yes	Cannot autoset this type of trace An attempt was made to autoset a trace which cannot be manipulated, such as a stored waveform or a counter view trace.
212	yes	Cannot autoset with empty slots Autoset was requested on a trace which represents an empty compartment or a plug-in which is not an 11000-series unit.
213	no	Cannot autoset, channel not available Autoset was requested for a channel which does not exist, such as channel 4 of a two-channel amplifier.
214	yes	Autoset is disabled An attempt to autoset was made while the Autoset parameters found in the UTILITY menu were turned off.
225	yes	Delayed trigger source #1 has been changed A new Main Trigger source was selected which conflicted with the present Dly1 Trigger source. The Dly1 source was changed to be the same as the Main trigger source to resolve the conflict.
	yes	Channel is not displayed A channel which cannot be displayed was selected for control by pressing its probe ID or display on/off button.

Remote Interfaces (event code)	Displayed on Screen	Message and Probable Cause
231	yes	DLY1 or DLY2 required to view intensified zones No intensified zones (delayed windows) were present while adjusting Δ Main, which controls the contrast between the main trace and its intensified zone(s).
232	no	Invalid trigger source description An attempt was made to create a semantically illegal trigger description.
233	no	Invalid trace description An attempt was made to create a semantically illegal trace description.
234	yes	Cannot measure counter or reference view traces An attempt was made to measure a counter view or stored waveform trace using the AUTOMEASURE START command or the MEASURE major menu.
235	yes	Measurement list is empty An attempt was made to measure without any measurements selected.
236	yes	Enhanced Accuracy available after warmup in %a min An attempt to execute self-calibration was made before the oscilloscope reached thermal stability. The typical warmup time is 20 minutes.
243	no	Function disabled by hardware strap
250	no	No trace currently defined An attempt was made to perform measurements without a trace present by using the AUTOMEASURE START command or the MEASURE major menu.
259	no	Illegal number of points designator An illegal byte-count in a binary waveform transmission was received.
263	no	Illegal channel specified An attempt was made, using the ABSTOUCH command, to access an amplifier channel which did not exist.
265	no	Illegal date/time argument The string sent to represent the date or time setting was incorrect.

Remote Interfaces (event code)	Displayed on Screen	Message and Probable Cause
267	no	Query response too long, truncated
272	no	Function not supported by plugin An attempt was made to access a plug-in function which did not exist, such as MINUSCOUPLING for a single-ended channel.
277	yes	Maximum number of traces already defined An attempt to create more than eight traces was made.
278	no	Main and window trace numbers cannot be the same An attempt was made to define a Window trace of the same trace number as a Main trace.
279	yes	Window trace requires a main (parent) trace An attempt was made to define a window without first defining the main trace from which it could be made.
280	no	Cannot create a window from a window trace An attempt was made to define a window trace made from another window trace.
281	yes	Cannot create a window from a reference trace An attempt to define a window from a stored waveform was made.
282	no	Cannot select an undefined trace The requested trace did not exist as specified in the SELECT TRACE command or no traces existed when the SELECT TRNEXT command was received.
283	yes	Trace does not exist An attempt was made to CLEAR an undefined trace.
284	yes	Requested coupling not available on %b%a An attempt was made to change a plug-in coupling to an invalid selection.
285	yes	Requested impedance not available on %b%a An attempt was made to change a plug-in impedance to an invalid selection.
286	yes	Delayed trigger source #2 has been changed A new Main Trigger source selection was made, which conflicted with the present Dly2 Trigger source. The Dly2 source was changed to be the same as the Main to resolve the conflict.

Remote Interfaces (event code)	Displayed on Screen	Message and Probable Cause
287	yes	Delayed trigger sources #1 and #2 have been changed A new Main Trigger source selection was made, which conflicted with the present Dly1 and Dly2 Trigger sources. The Dly sources were changed to be the same as the Main trigger to resolve the conflict.
288	yes	Stored setting buffer #%a is empty An attempt was made to Recall setting from a location which had nothing stored in it.
290	yes	0 is not a legal value for set reference An attempt was made to use zero as a cursor 100%, 0 dB, or 360 degree reference value.
291	yes	Delayed window required for Time A→B When using the counter timer to make timing measurements between sweeps, one or two delayed windows are needed.
292	yes	Start is Main Trig – One Start needs a Start Event When Holdoff by Events was used and the Start Event was set to None and One Start was changed to On, the Start Event could not remain set to None. To resolve this, the oscilloscope changed the Start Event to Main Trig.
293	yes	Count event forced to Main Trig When Holdoff by Events was used and the Count event was 2 ns and One Start was changed to On, the Count event could not remain set to 2 ns. To resolve this, the oscilloscope changed the Count event to Main Trig.
294	yes	One Start forced to OFF When Holdoff by Events was used and One Start was set to On, and the Start Event was changed to None, One Start could not remain set to On. To resolve this, the oscilloscope changed One Start to Off.
295	no	Command cannot be executed while GPIB in RWLS
296	no	Undefined cell, ABSTOUCH not executed An attempt was made to address an undefined button with the ABSTOUCH command.

Remote Interfaces (event code)	Displayed on Screen	Message and Probable Cause
308	yes	Level 2 probe checksum error on channel %b%a An internal plug-in/probe communication failure occurred.
351	yes	Counter timer phaselock loop not locked A hardware failure occurred with the Counter/Timer internal oscillator and phase-lock loop control.
352	yes	Counter Timer PLL unlocked – check ext ref input A hardware failure occurred with the Counter/Timer external oscillator and phaselock loop control. This is usually caused by a missing external oscillator reference.
394	yes	Self-test failure
397	yes	Internal DAC overflow on channel %a of %B plugin A hardware failure occurred in the plug-in.
400	no	No status to report
401	no	Power on initialization complete
403	no	User requested SRQ, front panel button The front panel button label SRQ was pressed.
457	no	Probe %a ID button pressed on %B plugin A probe ID button was pressed.
459	no	SRQ pending, cannot query event without serial poll An SRQ occurred which must be polled before the oscilloscope cannot send the accompanying Event query response.
460	no	Self test completed successfully
461	yes	Self calibration completed successfully All portions of self-calibration passed and the oscilloscope entered the Enhanced Accuracy state.
462	yes	Default initialization of scope complete
463	yes	Measurement block complete The measurements performed using the AUTOMEASURE START command or the MEASURE major menu were completed.

Remote Interfaces (event code)	Displayed on Screen	Message and Probable Cause
464	yes	Autoset complete The autoset process completed successfully.
465	no	Self calibration due A temperature change of more than 5° C occurred since the last self-calibration. The oscilloscope is not in the Enhanced Accuracy state.
466	yes	Selected front panel setting #%a recalled The requested oscilloscope settings were successfully recalled from memory.
467	no	Counter timer measurement aborted
468	no	Counter timer measurement completed A new Counter/Timer measurement result was available.
470	yes	Storage in buffer #%a complete The requested oscilloscope settings were successfully stored in memory.
471	no	20 minute warmup complete Self-calibration can be performed. The oscilloscope has reached thermal stability.
472	no	Automatic Self Calibration occurring When the self-cal mode was set to Automatic and a 5° C change was detected, self-calibration was initiated.
473	no	Warmup complete. New config requires Cal. Press EA After warmup and a new plug-in configuration was detected, self-calibration was needed.
476	yes	Mainframe amplifier calibration failed
477	yes	Left plugin calibration failed
478	yes	Center plugin calibration failed
479	yes	Right plugin calibration failed
480	yes	Trace separation calibration failed
481	yes	Trigger calibration failed
482	yes	Sweep calibration failed
483	yes	Sweep position calibration failed

Remote Interfaces (event code)	Displayed on Screen	Message and Probable Cause
484	yes	Enhanced Accuracy requires 11000 series plugins This occurs if Enhanced Accuracy is attempted without 11000-series plug-ins installed.
485	yes	Counter Timer measurement error. Pulse too short The event detected had a pulse width too short to count accurately. A narrow spike, less than 1 ns, will cause this error. Care should be taken to band limit the signal by using the amplifier's HF limit feature or the trigger's HF Reject feature.
550	no	%A argument is out of range
551	no	Invalid setting – fp calibrator not changed
553	no	Measurement not selected – no result to query
554	no	Trigger mode not single sequence – reset ignored
555	yes	Source M&D1 Trig – Ext A&B can be Gate OR Source When a Counter/Timer measurement Source was External A or B, and Gating was changed to Ext A→B, or A or B Ext, the Source could not remain at that setting. To resolve the conflict the oscilloscope changed the Source to M&D1 Trig.
556	yes	Source is Main Trig – Cannot Gate Dly2 by Dly1 When a Counter/Timer measurement Source was Dly2 Trig, and Gating was changed to Dly1 Swp, the Source could not remain as Dly2 Trig. The oscilloscope changed the Source to Main Trig to resolve the conflict.
557	yes	Gating is off – Ext A&B can be Gate OR Source When a Counter/Timer measurement Gating choice was Ext A→B, or A Ext and the Source was changed to A&B Ext or B Ext, the Gating choice became incompatible. The oscilloscope changed the Gating to Off to resolve the conflict.
558	no	No probe on + channel %b %a – probe offset saved The setting for probe offset was received without an offset probe attached to the + input of a differential amplifier. The value was accepted.

Remote Interfaces (event code)	Displayed on Screen	Message and Probable Cause
559	no	No probe on – channel %b%a – probe offset saved The setting for probe offset was received without an offset probe attached to the – input of a differential amplifier. The value was accepted.
560	yes	Source Dly2, for best result remove Dly1 window When a Frequency, Period, or Width measurement used Dly2 Trig as the Source while Dly1 window was present, an erroneous measurement was made. To ensure a valid result, Dly1 window should not be present.
561	yes	Source Dly1, for best result remove Dly2 window When a Frequency, Period, or Width measurement used Dly1 Trig as the Source while Dly2 window was present, an erroneous measurement was made. To ensure a valid result, Dly2 window should not be present.
562	yes	All front panel storage buffers are empty A settings recall was attempted with nothing stored in memory.
563	yes	Holdoff set below minimum for current Time/div Holdoff was 2ns Step and the Time/div was changed such that the holdoff setting was less than the minimum allowed for that Time/div.
564	yes	Use Norm trigger mode for best results Holdoff was not set to Time and the trigger mode was P-P or Auto.
565	yes	Holdoff by 2ns step invalid slower than 50 ms/div Holdoff by 2ns Step is not valid when the Main Time/div is slower than 50 ms.
566	no	Undersized number, display zero
567	no	Large negative number, display –infinity
568	no	Large positive number, display +infinity
569	no	Illegal number (NaN)

Remote Interfaces (event code)	Displayed on Screen	Message and Probable Cause
570	yes	Gating is Off – Cannot Gate Dly2 by Dly1 When a Counter/Timer measurement Gating was Dly1 Swp and Source was changed to Dly2 Trig, the Gating could not remain as Dly1 Swp. The oscilloscope changed the Gating to Off to resolve the conflict.
571	yes	Source M&D1, for best results remove Dly2 window When a Time A→B, Total, or Ratio measurement used M&D1 Trig as the Source while Dly2 window was present, an erroneous measurement was made. To ensure a valid result, Dly2 window should not be present.
572	yes	Counter timer TOTAL measurement has been stopped An automatic process such as Autoset, Automeasure, or Self-calibration interrupted the Counter/Timer totaling function and the totaling was stopped.
651	yes	Input channel %a overload on %B plug-in
652	yes	Input channel %a overdrive on %B plug-in
653	no	RS232 input parity error
654	no	RS232 input framing error
655	no	RS232 input buffer overrun
656	yes	Delayed sweep missing
657	yes	Last setup lost. Factory defaults have been used. The oscilloscope was unable to restore the last settings upon power-on. Battery backed-up memory contents have been lost or corrupted.

Note: In the above table, the character % represents several possibilities:

%a represents an integer number.

%b represents the short form for the L, C, or R plug-in compartment.

%A represents the argument name.

%B represents the long form for the LEFT, CENTER, or RIGHT plug-in compartment.

Messages Displayed only on the Screen and not available to the external interfaces:

Temp change since last Cal. Press EA to restore

Self-cal mode was set to Manual, and a 5° C change was detected. Pressing the Enhanced Accuracy button or SELFCAL FORCE command was required to restore the oscilloscope to the Enhanced Accuracy state.

Press EA again to confirm request

The front panel Enhanced Accuracy button was pressed. Two presses are required to begin self-calibration.

Probe cal completed

Probe calibration for the Right plug-in was successfully completed.

Probe cal completed: check LF compensation

Dc probe calibration for the Left or Center plug-in was successfully completed. Manual adjustment of the low-frequency response of the probe can be made.

No cal signal detected: Attach probe to hook

Probe calibration was attempted but no signal found for that probe.

Probe cal failed

The plug-in was unable to properly adjust for the attached probe.

COUNTER: Waiting to Finish Measurement

The counter timer started a measurement but either the measured signal or applied gate was lost.

COUNTER: Still measuring. Averages = xxxxx

The selected number of averages in combination with the signal repetition rate caused the measurement to take a long time to complete. Nothing was wrong. This message appears to indicate activity.

COUNTER: Waiting to Start Measurement

The counter timer was waiting to begin a measurement. Either the signal was not triggered or the gating source was not present.

WARNING: DELAY intensity exceeds limit

The Dly'd intensity setting of the 11302 was too high. The intensity will be shut off if the condition persists.

WARNING: MAIN intensity exceeds limit

The Main intensity setting of the 11302 was too high. The intensity will be shut off if the condition persists.

WARNING: XY intensity exceeds limit

The XY intensity setting of the 11302 was too high. The intensity will be shut off if the condition persists.

Select a measurement before pressing start

Start was touched in the Measure major menu with no measurements selected from the Meas List.

Probe Skew does not apply to this type of trace

An attempt was made to adjust an XY trace or a stored waveform.

Messages Displayed
only on the Screen
and not available
to the external
interfaces: (cont)

Setting buffer erased

Erase was touched in the Store Recall major menu.

Use Time Holdoff for best results

Holdoff was set to Countdown, 2nsStep, or Events and the trigger mode was changed to P-P or Auto.

Select Auto or 1 Average when using Single Seq.

To ensure a complete measurement when using Single Sequence, the counter timer average selection should be set to Auto or 1.

Use left or center channel for vertical component

Right channel was touched while vertical portion of trace was being defined.

Remaining channels may not be inverted

Minus operator was touched but all the remaining channels are non 11000-series, non-invertable 11000-series or external (in trigger source menu).

Must define vertical component of trace first

Vs was touched before a vertical channel was entered.

Trace is already an XY trace

Vs was touched while defining horizontal component of trace.

Cannot use same channel twice in expression

A channel that is already part of trace description was touched.

Cannot use left channel for horizontal component

Left channel was touched while horizontal portion of trace was being defined.

Touch a right channel, center channel already used

Center channel was touched while defining horizontal portion of trace. Vertical component contains a center channel.

Use center channel for horizontal component

Right channel was touched while defining horizontal component but center channel is already part of the horizontal component of some trace description, not necessarily part of the current trace.

Use right channel for horizontal component

Center channel was touched while defining horizontal component but right channel is already part of the horizontal component of some trace description, not necessarily part of the current trace.

Channel must use same operator as it used in Main

An illegal channel was touched. The most recently selected operator would cause this channel to have a polarity that is opposite to the polarity that this channel uses in the main trigger source menu. This occurs while in either of the delayed trigger source menus.

Both delayed sources must use same external signal

Ext was touched in a delayed trigger source menu while the other delayed trigger source is using Ext/5 and vice versa.

Messages Displayed only on the Screen and not available to the external interfaces: (cont)

Only 11K plugin channels may be inverted

External channel was touched after selecting MINUS as the operator. A non 11000-series channel was touched after selecting the MINUS operator.

No more channels available, touch "Enter"

PLUS or MINUS was touched but there are no more channels to combine.

Cannot create XY trace, no channels available

Vs was touched while it was dim. It is dimmed because there is no valid way to make an XY trace at this time. Usually this happens when the vertical component of the current trace has a center channel and some other trace has a horizontal component with a center channel. It can also happen if either or both the left and center compartments contain smart plugins.

Already using two channels, touch "vs" or "Enter"

PLUS or MINUS was touched after the limit of 2 channels per trace component was reached.

Already using two channels, touch "Enter"

PLUS or MINUS was touched after the second horizontal component was defined.

Too many traces. Touch "Clear" to delete one

A channel or operator in the waveform menu was touched when there are already 8 traces defined.

This plugin does not support channel inversion

A non-invertable 11000-series plug-in channel was touched after selecting the MINUS operator.

Remaining channels must use "+" operator

MINUS was touched in a delayed trigger source menu at a point when the remaining channels must have a positive polarity. The channel's polarity must be positive because that's the way it was used in the main trigger source.

Remaining channels must use "-" operator

PLUS was touched in a delayed trigger source menu at a point when the remaining channels must have a negative polarity. The channel's polarity must be negative because that's the way it was used in the main trigger source.

Delayed trigger source cannot use A external input

Main Trig was touched while the main trigger source is an external channel.

External inputs may not be combined

PLUS or MINUS was touched after selecting an external as a trigger source.

Touch "Main Trig" to use right channels

Right channel was touched while the main trigger source consisted of a composite source from the right compartment.

**Messages Displayed
only on the Screen
and not available
to the external
interfaces: (cont)**

Trigger expression is already using two channels
PLUS or MINUS was touched after defining second channel in trigger source.

Touch "Main Trig" to use center channels
Center channel was touched while the main trigger source consisted of a composite source from the center compartment.

Touch another plugin channel or touch "Enter"
External channel was touched after selecting an operator for the second channel for one of the trigger sources.

Please choose a right compartment channel
A left or center channel was touched but the first channel of the trigger source is from the right compartment.

Please choose a left or center compartment channel
A right channel was touched but the first channel in the trigger source is a left or center channel.

Touch "Main Trig" to use left channels
Left channel was touched while the main trigger source consists of a composite source from the left compartment.

Numeric entry not available
For the knob selection, numeric entry was not allowed. This occurs if Cursors are selected or if nothing is selected for the knob.

Index

Index

- 10X Mag, 2-50,55,190
- 12 Hour, 2-178
- 2 ns, 2-78
- 2 ns Step, 2-77,79
- 24 Hour, 2-178
- 5 V, Calibrator Signal Menu, 2-167
- 500 mV, Calibrator Signal Menu, 2-167

- A Ext**, 2-128,132
 - Counter menu, 2-109,112,117,118
 - Holdoff Events menu, 2-78
 - Trigger Source menu, 2-88
 - Waveform, Count View menu, 2-68
- A Ext+5**, 2-89,92
- A External, 2-90,116,128
- A&B Ext**, 2-111,116,117
- Acquisition, 2-39
- Accessory List, *Appendix B*
 - Optional, *Appendix B*
 - Recommended, *Appendix B*
 - Standard, *Appendix B*
- Addition operator
 - Numeric Entry menu, 2-154,155,156
 - Trigger Source menu, 2-89,92
 - Waveform, Scope menu, 2-70
- ADDR**, GPIB menu, 2-169
- Address (GPIB), 2-169
- After Dly*, 2-46,47,51,95,126,202
- After HO*, 2-78
- Alt**, 2-50
- AMP**, Calibrator Signal menu, 2-167
- Amplifier, 2-39,65
- AMPLITUDE**, 2-164
- Architecture, Instrument, *xix*, 2-145
- Armed, 2-12,17,93
- ASCII interfaces operating conventions, 3-31
- ASCII settings, 3-55,56
- Astigmatism, 2-14,97,101
- Auto**
 - Cal menu, 2-166
 - Counter menu
 - Averages, 2-109,111,116,118
 - Update, 2-109,111,116,118
 - Horizontal menu, 2-50
 - Trigger Level menu, 2-83,85
- Automatic scaling, 2-7
- Autoset, 2-7,40-44, 61,136
 - Menu, 2-163,164
- AUTOSET**, Probe ID menu, 2-174
- Autoset Commands (external), 3-38
 - AUTOSET**, 3-38
- Averages*, 2-109,111,116,118
- Averaging*, 2-105,110,115

- B Ext**
 - Counter, Gating menu, 2-111,118
 - Holdoff Events menu, 2-78
 - Trigger Source menu, 2-89,92
 - Waveform, Count View menu, 2-68
- B Ext+5**, 2-89,92
- B External, 2-79,90,107,128
- Bandwidth, 4-36
- Battery Backup, 1-2

- BAUD**, 2-176
- BEAM FIND**, 2-6,45
- Beep menu, 2-163,165
- Beeper, 2-163,165
- Binary settings, 3-55,56
- Brightness, 2-102
- Buttons, *see Controls*

- C**, 2-89
- Cables, 2-179
- Cal menu, 2-163,166
- Calc**, 2-156
- Caldron, 2-79
- Calendar, 2-163,178
- Calibration, 2-8,22,163,166
- Calibration, instrument (external), 3-65,66,69-71
- Calibrator, 2-9,182,221
 - Menu, 2-167
- Cameras, *Appendix B*, 2-9
- Center, compartment, 2-3,15,135
- Char Bits, RS232 menu, 2-176
- Character set, 3-106,107
- Characteristics
 - Electrical, 4-1
 - Environmental, 4-31
 - Physical, 4-33
- Channel, Vertical menu, 2-65
- Channel Commands (external), 3-40
 - CH<compartment><ui>, 3-40
- Chop**, 2-50
- CHS**, 2-154,155,157
- Clear**, 2-55,65,79
 - Numeric Entry menu, 2-125,155,156,199
 - Trigger Source menu, 2-89
 - Waveform, Count View menu, 2-68
 - Waveform, Ref menu, 2-69
 - Waveform, Scope menu, 2-71
- Clock, 2-16,141,163,172,178
- Command Set (external)
 - Abbreviating reserved words, 3-102
 - Command structures, 3-25,26,27
 - Processing conventions, 3-28,29
 - Syntax conventions, 3-23,24,25
 - Syntax and Descriptions, 3-38,39,101
- Comparator, 2-84,134
- Connectors
 - CALIBRATOR**, 2-8
 - Front Panel, 2-15
 - Interface, 2-19
 - Rear Panel, 2-16
 - Trigger READY, 2-17
 - Trigger RESET, 2-17
 - Power, 2-18,20
- Contrast: IEEE-488 vs RS-232-C, 3-3
- Control menus, 2-10
 - Counter, *see Counter menu*
 - Cursors, *see Cursors menu*
 - Horizontal Size and Position, *see Horizontal menu*
 - Horizontal Delay, *see Horizontal menu*
 - Trigger Holdoff, *see Trigger Holdoff menu*
 - Trigger Level, *see Trigger Level menu*
 - Vertical Size, Position & Offset, *see Vertical menu*
- Controllers, 3-4

- Controls
 - AUTOSET button, 2-6
 - BEAM FIND, 2-6
 - Control Knobs, 2-10
 - Control Menu, 2-10
 - ENHANCED ACCURACY, 2-6
 - FP LOCK, 2-6
 - INTENSITY, 2-7
 - Major Menu, 2-13
 - SRQ, 2-6
- Count, Holdoff Events Menu, 2-79
- Count In**, 2-68
- Count Ref*, Numeric Entry menu, 2-156
- Count View*, Waveform menu, 2-68
- Countdown**, 2-15,87,88,89,90
- Counter/Timer, 2-10,12,16,17,47,68,75,105-142,156,192-198,199
- Counter/Timer Commands (external), 3-43
 - CTCLOCK, 3-43,46,47
 - CTFREQUENCY, 3-43,45,46
 - CTPERIOD, 3-43,45,47
 - CTMEAS, 3-43,44,46
 - CTRATIO, 3-43,45,46
 - CTRESET, 3-43,44
 - CTRESULT?, 3-43,44,46
 - CTTIME, 3-43,45,47
 - CTTOTAL, 3-43,45,47
 - CTWIDTH, 3-43,45,47
- Counter View, 2-68,127-129, 132,193
- Coupling
 - Trigger Level menu, 2-83,84
 - Vertical menu, 2-65
- Creation (traces), 2-70
- CRT**, 2-169
- CT Ext A**, 2-85,87,141
- CT Ext B**, 2-85,87,141
- Cursors, 2-12,36,143-148,182-191
- Cursors menu, 2-143
- Cursor Commands (external), 3-48
 - CURSOR, 3-48,49,51
 - HCURSOR, 3-48,49,51
 - HDELTA?, 3-48,50,51
 - HREF?, 3-48,50,51
 - H1ABS, 3-48,49,51
 - H2ABS, 3-48,49,51
 - H1REL, 3-48,49,51
 - H2REL, 3-48,49,51
 - VCURSOR, 3-48,49,51
 - VDELTA?, 3-48,50,51
 - VREF?, 3-48,50,51
 - V1ABS, 3-48,49,51
 - V2ABS, 3-48,49,51
 - V1REL, 3-48,49,51
 - V2REL, 3-48,49,51
- Data Transfer Commands (external), 3-52
 - CURVE, 3-52,53,55
 - ENCDG, 3-52,54,55,56
 - INPUT, 3-52,54,56
 - OUTPUT, 3-52,54,56
 - SET?, 3-52,55,56
 - WAVFRM?, 3-52,55,56
 - WFMPRE, 3-52,53,56
- DATE**, 2-149,178
- Dc Coupling, 2-94
- DCE, 2-15
- DCL operating conventions, 3-33
- DEBUG**, 2-169,170
- Degrees, 2-147,184
- Dly1 Swp**, 2-109,111,117,118
- Dly1 Trig**, 2-109,111,118
- Dly2 Trig**, 2-109,111,118
- Dly'd**, Horizontal Size and Position menu, 2-50
- Delay**, Horizontal Delay menu, 2-50
- Delayed time base, 2-9,46-49,197
- Δ Char, 2-97
- Δ Main, 2-97
- Diagnostic Commands (external), 3-57
 - TEST, 3-57,58
- Diagnostics, 2-25
- Differential, 2-134
- Disarm, 2-107
- Discriminating, 2-137
- DISP ADJ menu, 2-14,97
 - Exception, 2-36
 - Initialized state, 2-31
 - Knob assignment, 2-38
 - Knob behavior, 2-111
- Display**, Horizontal menu, 2-50
- Display Commands (external), 3-59
 - DISPLAY, 3-59
- Display patterns, 2-99,100
- Division operator, 2-154,155,156
- Dly Trig**, Holdoff Events menu, 2-78
- Dly'd**, I/O BNC menu, 2-172
- Dly1**
 - Trigger Level menu, 2-83
 - Trigger Source menu, 2-89
- Dly2**
 - Trigger Level menu, 2-83
 - Trigger Source menu, 2-89
- Drawings, dimensional, 4-34
- Duty, Measure menu, 2-149
- EEX**, Numeric Entry, 2-155-157
- Enhanced Accuracy, 2-7,22-25,166
- Enter**, 2-80,81,84,85,135,188,221
 - Numeric Entry menu, 2-153,154,155,156
 - Trigger Source menu, 2-89,92,93
 - Waveform, Count View menu, 2-68
 - Waveform, Ref menu, 2-69
 - Waveform, Scope menu, 2-71
- EOI**, 2-32,169,170
- EOI and LF**, 2-169,170
- Erase**, 2-160,161,223
- Even**, RS232 menu, 2-176
- Event, system
 - Codes, 3-116,117,118-124
 - Handling, 3-112,113
 - Reporting, 3-111
 - Power up, 3-12
- Events, 2-78-81,141,200
- Exponential, 2-56
- Ext, 2-87,89,92,106
- Ext 10 MHz**, I/O BNC menu, 2-172
- Ext A→B**, 2-109,111,117,118
- Extended Test menu, 2-163,168
- External, 2-15

- Fast** (rise), 2-167
- FINE** button, 2-10,35
- Focus**, 2-14,97,99
- FP LOCKED**, 2-7
- FREQ**, Calibrator Signal menu, 2-167
- Freq**
 - Counter menu, 2-109
 - Measure menu, 2-149
- Frequency**, 2-84,107-109,130,136-138,192,195
- Fuse holder**, 2-18

- Gate**, 2-16,107,128,132,135,137,195-198
 - Waveform, Count View menu, 2-68
- GATE OUT**, I/O BNC menu, 2-172
- Geometry**, 2-99
- Glossary**, *Appendix A*
- GPIB**, 2-6,19,26,163,169
 - Menu, 2-169
- GPIB**,
 - Command Groupings for
 - Autoset, 3-38
 - Channel, 3-40
 - Counter/Timer, 3-43
 - Cursor, 3-48
 - Data Transfer, 3-52
 - Diagnostic, 3-57
 - Display, 3-59
 - Intensity, 3-60
 - Measurement, 3-62
 - Miscellaneous, 3-65
 - Probe ID, 3-73
 - RS-232-C, 3-74
 - Status & Event, 3-77
 - Store Recall, 3-84
 - Text, 3-83
 - Time Base, 3-84
 - Trigger, 3-87
 - Trigger Holdoff, 3-91
 - Waveform/Setting, 3-95
 - Window Delay, 3-100
 - Window Trigger, 3-101
 - Configuration, 3-9,10
 - Features, 3-2
 - Interface functions, 3-4
 - Messages, 3-5
 - Interface, 3-5
 - Device dependent, 3-5,7,16-20
 - Menu, 3-13
 - Power up SRQ, 3-12
 - Protocol, 3-4
- GPIB & RS-232-C commands**,
 - ABSTOUCH, 3-65,67,68
 - ALLEV?, 3-77,78,80,81
 - AUTOMEASURE, 3-62,63
 - AUTOSET, 3-38
 - CALIBRATOR, 3-65,69,71
 - CALSTATUS?, 3-65,66,70
 - CH<compartment><ui>, 3-40
 - CLEAR, 3-95,97
 - CONFIG?, 3-77,79,80
 - CONTRAST, 3-60,61
 - CTCLOCK, 3-43,46,47
 - CTFREQUENCY, 3-43,45,46
 - CTPERIOD, 3-43,45,47
 - CTMEAS, 3-43,44,46
 - CTRATIO, 3-43,45,46
 - CTRESET, 3-43,44
 - CTRESULT?, 3-43,44,46
 - CTTIME, 3-43,45,47
 - CTTOTAL, 3-43,45,47
 - CTWIDTH, 3-43,45,47
 - CURSOR, 3-48,49,51
 - CURVE, 3-52,53,55
 - DATE, 3-65,67,70,72
 - DATIME?, 3-65,69,71
 - DEBUG, 3-65,66,70,72
 - DISPLAY, 3-59
 - DT, 3-65,67,71,72
 - ENCDG, 3-52,54,55,56
 - EVENT?, 3-77,78,81
 - EVQTY?, 3-77,78,81
 - ERASE, 3-82
 - FPANEL, 3-65,67,71
 - HCURSOR, 3-48,49,51
 - HDELTA?, 3-48,50,51
 - HELP?, 3-65,68,72
 - HOLDOFF, 3-91,92,94
 - HOEVENT, 3-91,93,94
 - HOCOUNTDOWN, 3-91,93
 - HREF?, 3-48,50,51
 - H1ABS, 3-48,49,51
 - H2ABS, 3-48,49,51
 - H1REL, 3-48,49,51
 - H2REL, 3-48,49,51
 - ID? 3-77,79,80,81
 - IDPROBE?, 3-77,79,80
 - INIT, 3-65,68
 - INPUT, 3-52,54,56
 - INTENSITY, 3-60,61
 - LONGFORM, 3-65,66,71
 - MEAS?, 3-62
 - MSLIST, 3-62,63
 - OUTPUT, 3-52,54,56
 - POWERON?, 3-65,69,71
 - PROBE, 3-73
 - RECALL, 3-82
 - REDIRECT, 3-65,66,70,71
 - RQS, 3-77,80,81
 - RS232, 3-74,75,76
 - SELECT, 3-95,96,97
 - SELF CAL, 3-65,70
 - SET?, 3-52,55,56
 - SPEAKER, 3-65,70,71,72
 - SRQMASK, 3-77,78,80,81
 - STBYTE?, 3-77,79,80,81
 - STORE, 3-82
 - TBDELAY, 3-84,85,86
 - TBDISPLAY, 3-84,86
 - TBGATEOUT, 3-84,86
 - TBMAIN, 3-84,86
 - TEST, 3-57,58
 - TEXT, 3-83
 - TIME, 3-65,66,70,72
 - TRAEXT, 3-87,88,89
 - TRACE<ui>, 3-95,96,97
 - TRACE?, 3-95,97,98
 - TRBEXT, 3-87,88,89
 - TRMAIN, 3-87,88,89

GPIB & RS-232-C commands (cont)

TR1DELAY, 3-87,88,89
 TR2DELAY, 3-87,88,89
 TR?, 3-87,88,89
 UID, 3-77,80
 UPTIME?, 3-65,69,71,72
 VCURSOR, 3-48,49,51
 VDELTA?, 3-48,50,51
 VERSION?, 3-77,79,80
 VREF?, 3-48,50,51
 V1ABS, 3-48,49,51
 V2ABS, 3-48,49,51
 V1REL, 3-48,49,51
 V2REL, 3-48,49,51
 WAVFRM?, 3-52,55,56
 WFMPRE, 3-52,53,56
 WIN1, 3-100
 WIN2, 3-100
 WIN?, 3-100
 WTMODE, 3-101

Graticule, 2-102,103
 Ground, 2-8

HF Limit, 2-65

Holdoff, 2-10,12,28,43,77-82
 Horizontal Cursors, 2-160,165,206
 Horizontal Delay, 2-46
 Horizontal menu, 2-50
 HORIZONTAL POSition, 2-27
 HORIZONTAL SIZE, 2-11,50,54,55,63

I/O Bnc, 2-19

Menu, 2-166,172
 I/O Buffer, 3-32
 Identify, 2-60,61,159,174
 Incoming inspection, 1-10
 Input Coupling, *see Coupling, Trigger Level menu*
 Impedance, 2-12,13,18,34,149,157,199
 Vertical menu, 2-65
 Initialize menu, 2-166,171
 Initialization, 2-27,171
 Inserting, 2-24
 Installation, 1-1
 Instrument Serial Numbers, *see cover*
 Int, I/O BNC menu, 2-172
 Intensified, 2-46
 Intensity, 2-7,17,28,38,50,63,102,103
 Intensity Commands (external), 3-60
 INTENSITY, 3-60,61
 CONTRAST, 3-60,61
 Interfaces, 2-19,62,169,176, *also see section 3*
 Introduction to oscilloscopes, xviii

Keypad, 2-135,156,157

Knob menus, *see Control menus*

L, 2-89

Left compartment, 2-15,75,135
 Left vertical output, 2-19
 LEVEL, 2-165
 LF Reject, 2-84
 Line, 2-89

Linefeed, 2-169
 Lockout, 2-61,62
 Loudness, 2-163

M Trig, 2-117

M&B Ext, 2-111

M&D1 Trig, 2-111,116,117

Main,

I/O BNC menu, 2-172
 Horizontal Size and Position, 2-50
 Horizontal Delay, 2-50
 Trigger Level menu, 2-83
 Trigger Source menu, 2-89

Main Trig

Counter menu, 2-109,111,118
 Holdoff Events menu, 2-78
 Trigger Source menu, 2-89

Main&Dly, 2-50

Major menus, 2-37

Disp Adj, *see DISP ADJ menu*
 Measure, *see MEASURE menu*
 Numeric Entry, *see NUMERIC ENTRY menu*
 Store/Recall, *see STORE and RECALL menu*
 Trigger Source, *see TRIGGER SOURCE menu*
 Utility, *see UTILITY menu*
 Waveform, *see WAVEFORM menu*

Man, 2-166

Manual, Counter menu, 2-109,111,116,118

Manual information, *see page i and Appendix B*

Max, Measure menu, 2-149

Meas List, 2-149

Measure, 2-107,109,111,116,117,118

Measure menu, 2-149

Measurement Commands (external), 3-62

AUTOMEASURE, 3-62,63

MEAS?, 3-62

MSLIST, 3-62,63

Measurement source, 2-112,126

Mld, Measure menu, 2-149

Mln, Measure menu, 2-149

Minus operator, *see Subtract*

Miscellaneous Commands (external), 3-65

ABSTOUCH, 3-65,67,68

CALIBRATOR, 3-65,69,71

CALSTATUS?, 3-65,66,70

DATE, 3-65,67,70,72

DATIME?, 3-65,69,71

DEBUG, 3-65,66,70,72

DT, 3-65,67,71,72

FPANEL, 3-65,67,71

HELP?, 3-65,68,72

INIT, 3-65,68

LONGFORM, 3-65,66,71

POWERON?, 3-65,69,71

REDIRECT, 3-65,66,70,71

SPEAKER, 3-65,70,71,72

SELFCAL, 3-65,70

TIME, 3-65,66,70,72

UPTIME?, 3-65,69,71,72

MODE

Cal menu, 1-166

GPIB menu, 1-169,170

Mode, Trigger menu, 2-85

Month, 2-178

Multiplication operator, 2-153,154,155

- New trace, 2-39,61,67,73,74,75
- Next, 2-78
- None, 2-78
- Nontracking, 2-146
- Nonzero, 2-125
- Norm, 2-83
- Nulling, 2-140,199
- NUMERIC ENTRY, 2-1,14,29,105,123-126,153-157

- Odd, RS232 menu, 2-176
- Off
 - GPIB menu, 2-169
 - Counter menu, 2-111,117,118
 - RS232 menu, 2-176
 - Time and Date menu, 2-178
- Off bus, 2-167,170
- Offset, 2-12,13,37,38,44,47,56,60,63-65,69,72,74,95-97,138,151,162,167,177,183-184,193
- One Start, 2-78
- Options, *see Section 5*
- Oven, 2-22,131,140,172

- P-P**
 - Measure menu, 2-149
 - Trigger Level menu, 2-83
- Packaging instrument, 1-8
- PAR, RS232 menu, 2-176
- Parent trace, 2-64
- Parity, 2-196
- %dB, 2-145,146
- %Degree, 2-144
- Period, 2-28,110,111,124,125,192
- Previous, 2-78
- Photographic, 2-93
- Photography, 2-9
- Plethora, 2-79
- Plug-in units, 6-1
 - 11A32
 - General Information, 6-11A32-1-1
 - Operating Information, 6-11A32-2-2
 - Specification, 6-11A32-3-1
 - 11A34
 - General Information, 6-11A34-1-1
 - Operating Information, 6-11A34-2-2
 - Specification, 6-11A34-3-1
 - 11A52
 - General Information, 6-11A52-1-1
 - Operating Information, 6-11A52-2-2
 - Specification, 6-11A52-3-1
 - 11A71
 - General Information, 6-11A71-1-1
 - Operating Information, 6-11A71-2-2
 - Specification, 6-11A71-3-1
- Position, 2-10,11,27,50,52,55,66
- Power Cord, 1-3,4
- Power plugs, 1-4
- Power supply,
 - ON/STANDBY, 1-6,2-3,20
 - PRINCIPAL POWER SWITCH, 2-21,23,24,157
- Power up, 2-22
 - Initialize, 2-27
 - Self-test, 2-25
- PRINCIPAL POWER SWITCH, 2-18,20-22
- Probe Cal, 2-17,32,200
 - Menu, 2-166,173
- Probe calibration, 2-173
- Probe ID, 2-29,39,57-62,75,150
 - Menu, 2-166,174
- Probe ID Commands (external), 3-73
 - PROBE, 3-73
- Probe Skew menu, 2-17,166,175
- Probe-Tip Jack, 2-8
- Programs,
 - Developing applications, 3-15,16-21
 - Optimizing system performance, 3-131-133

- Query commands, 3-26-27

- R, 2-89**
 - Rackmounting, 1-9
 - Ratio, 2-105,111,124,126,130,131
 - Ready, 2-12,17,94
 - Rearming, 2-106
 - Recall, 2-1,14,29,60-62
 - REFCLOCK, 2-172
 - Reference menu, 2-69
 - Rejection, 2-84
 - Requesting service,
 - RQS Command, *see "Status & Event Commands"*
 - RQS button, 3-110
 - Reserved words, 3-103,104,105
 - Reset, 2-12,17,93,94,126
 - Right compartment, 2-57,74,75
 - RS232, 2-32,91,169
 - Menu, 2-166,176
 - RS-232-C,
 - Control Commands (external), 3-74
 - RS232, 3-74-76
 - Command Groupings for
 - Autoset, 3-38
 - Channel, 3-40
 - Counter / Timer, 3-43
 - Cursor, 3-48
 - Data Transfer, 3-52
 - Diagnostic, 3-57
 - Display, 3-59
 - Intensity, 3-60
 - Measurement, 3-62
 - Miscellaneous, 3-65
 - Probe ID, 3-73
 - RS-232-C, 3-74
 - Status & Event, 3-77
 - Store Recall, 3-82
 - Text, 3-83
 - Time Base, 3-84
 - Trigger, 3-87
 - Trigger Holdoff, 3-91
 - Waveform / Setting, 3-95
 - Window Delay, 3-100
 - Window Trigger, 3-101
- Configuration, 3-10
- Functional characteristics, 3-7
- Messages, 3-8
- Menu, 3-14
- Special RS-232-C I/O operations, 3-33
 - Binary block data transfer, 3-34
 - Echo, 3-34
 - Emulation of GPIB interface messages, 3-33
 - Flagging, 3-74
 - Pinout and cable connections, 3-35
 - SRQ reporting, 3-35

- Running, 2-117
- Runs, 2-78
- Runs After Dly, 2-90
- Safety, *xvi*
- Sawtooth, 2-16
- Scale factor, 2-9,38,73,75
- Scope menu, 2-70
- SELECT, Time and Date menu, 2-178
- Selected trace, 2-49,51,63,64,71,149,150
- Selecting an interface, 3-2
- Self test, 2-22-26
- Sensitivity, 2-92-94
- Sequence, 2-62,86,93,94
- SEQUENCE, 2-174
- Sequencing, 2-159,174
- Service requests (SRQ),
 - SRQ responses, 3-114
 - SRQ, using, 3-109
 - Status Byte Definition, 3-114
 - Status Conditions, 3-114,115
- Servicing, 2-168
- SET, Time and Date menu, 2-178
- Set commands, 3-18-20,27
- Set Ref, 2-144-146
- Setups, 2-159
- Shutdown, 2-102-103
- Single, 2-83
- Slope, 2-83,85,135
- Source, Counter menu, 2-109,111,116-118
- Sources, 2-13,72-75,88-92,105,126
- Spot Shift, 2-100
- SRQ, 2-6,26,62
- Standby, 2-6,20-22
 - Measure menu, 2-134-135
- Status and Event Commands (external), 3-77
 - ALLEV?, 3-77,78,80,81
 - CONFIG?, 3-77,79,80
 - EVENT?, 3-77,78,81
 - EVQTY?, 3-77,78,81
 - ID?, 3-77,79,80,81
 - IDPROBE?, 3-77,79,80
 - RQS, 3-77,80,81
 - SRQMASK, 3-77,78,80,81
 - STBYTE?, 3-77,79,80,81
 - UID, 3-77,80
 - VERSION?, 3-77,79,80
- Status and event reporting, 3-109
- Stop, Measure menu, 3-149
- Stopped, 2-117
- Stop Bits, RS232 menu, 2-176
- Store, 2-159-161
- STORE and RECALL menu, 2-159
- Store Recall Commands (external), 3-82
 - ERASE, 3-82
 - RECALL, 3-82
 - STORE, 3-82
- Subtract operator
 - Numeric Entry menu, 2-154,155
 - Waveform, Scope menu, 2-70
- Sweep gate, 2-125,139
- Sweep gate output, 2-16
- Swp Start, 2-114,116
- Sync Gate, 2-68
- System Bandwidth, 4-36
- System Rise Time, 4-36
- System Performance (with Interfaces),
 - Considerations for, 3-125
 - Estimating, 3-126-131
 - Optimizing, 3-131-133
- Talk/Listen, GPIB menu, 2-169-170
- Talked With Nothing To Say, 3-33
- Target entry, 2-154,156
- TERM, 2-169-170
- Test equipment, 1-10
- Test menu, 2-166,177
- Test, 2-93,98
- Text Commands (external), 3-83
 - TEXT, 3-83
- Time, Holdoff, 2-77
- TIME, Time and Date menu, 2-178
- Time A→B, 2-116
- Time and Date, 2-178
- Time Base, Horizontal Size and Position menu, 2-50
- Time Base Commands (external), 3-84
 - TBDELAY, 3-84-86
 - TBDISPLAY, 3-84,86
 - TBGATEOUT, 3-84,86
 - TBMAIN, 3-84,86
- Time bases, 2-42,52,53,93
- TIMING, 2-164
- Total, 2-107
- Touch screen, 2-12,103
- Trace description, 2-63,74,127
- Trace expression syntax (external), 3-95
- Trace rotation, 2-14,97,98
- Tracking, 2-27,146
- Trig Level, 2-120
- Trig On, 2-78
- Trig'd
 - Holdoff Events menu, 2-78
 - Horizontal Delay menu, 2-50
- Trigger, Trigger Level menu, 2-83
- Triggering Commands (external), 3-87
 - TRAEXT, 3-87-89
 - TRBEXT, 3-87-89
 - TRMAIN, 3-87-89
 - TR1DELAY, 3-87-89
 - TR2DELAY, 3-87-89
 - TR?, 3-87-89
- Trigger Holdoff menu, 2-77
- Trigger Holdoff Commands (external), 3-91
 - HOCOUNTDOWN, 3-91,93
 - HOEVENT, 3-91,93,94
 - HOLDOFF, 3-91,92,94
- Trigger LEVEL, 2-10,28,83-86
- Trigger pending, 2-93
- Trigger reset, 2-93
- Trigger source, 2-13,88-91
- Trigger Source menu, 2-88
- Trigger source expression syntax (external), 3-89
- TYPE, Calibrator Signal menu, 2-167
- Using this manual, *see page ii*
- Utility Menu, 2-163
- Units, 2-37
- Update, 2-109,111,116,118,119

User interfaces I/O synchronization, 3-31

Versus, 2-13

Vertical Cursors, 2-147,182

Vertical menu, 2-65

VERTICAL POSition, 2-27

VERTICAL SIZE, 2-10,11,32,65,66

View, 2-50

Vs, 2-16,84,85,138

 Waveform, Scope menu, 2-70

Waveform Commands (external), 3-95

 CLEAR, 3-95,97

 SELECT, 3-95-97

 TRACE<ui>, 3-95-97

 TRACE?, 3-95,97,98

Wfm1, 2-29,69

Wfm2, 2-29,69

Wid, 2-149

Width, 2-28,124,126,130,149

Window, 2-46-48,51

Window Delay Commands (external), 3-100

 WIN1, 3-100

 WIN2, 3-100

 WIN?, 3-100

Window Trigger Commands (external), 3-101

 WTMODE, 3-101

Window1, 2-46-48,51

Window2, 2-46-48,51

XY trace, 2-48,53,54,63,75,143,144,147

Year, 2-178

YT trace, 2-52,55,143,144

MANUAL CHANGE INFORMATION

At Tektronix, we continually strive to keep up with latest electronic developments by adding circuit and component improvements to our instruments as soon as they are developed and tested.

Sometimes, due to printing and shipping requirements, we can't get these changes immediately into printed manuals. Hence, your manual may contain new change information on following pages.

A single change may affect several sections. Since the change information sheets are carried in the manual until all changes are permanently entered, some duplication may occur. If no such change pages appear following this page, your manual is correct as printed.

DESCRIPTION

PG. 47

Effective for all serial numbers:

Remove page 4-11/4-12 from the manual and replace it with the attached new page.

DESCRIPTION

PG. 47

TEXT CHANGES

CHANGE TO:

SECTION 2, page 2-4, Adding and Subtracting Waveforms, change to read:

Adding Waveforms

NOTE

Before adding waveforms, check that each channel's display is independently on screen.

The 11301 and 11302 allows the addition of any two channels. That is, one channel may be added to a channel from another plug-in unit. A simple restriction applies. Each channel must be in its linear operating range. This is assured if each channel separately is within the screen area before addition.

Those portions of a trace which are off screen will not be valid when brought back on screen using another channel's input signal or Offset control. This general restriction applies to any dual-channel oscilloscope.

Pull and Replace the text pages 3-95 and 3-96 included with this insert.

In Section 6 change the cautions to read:

On page 1-3, for 11A32

CAUTION

To avoid instrument damage set the mainframe ON/STANDBY switch to STANDBY before installing or removing the 11A32.

If the green indicator light remains ON, when the STANDBY position is selected, the switch has been internally disabled.

To remove or reinstall plug-in units, use the Principal Power Switch (rear panel) to shut OFF the power. This will prevent damage to either the plug-in or the mainframe.

To once again enable the ON/STANDBY switch, refer the instrument to qualified service personnel.

DESCRIPTION

On page 1-3, for 11A34

CAUTION

To avoid instrument damage set the mainframe ON/STANDBY switch to STANDBY before installing or removing the 11A34.

If the green indicator light remains ON, when the STANDBY position is selected, the switch has been internally disabled.

To remove or reinstall plug-in units, use the Principal Power Switch (rear panel) to shut OFF the power. This will prevent damage to either the plug-in or the mainframe.

On page 1-3, for 11A71

CAUTION

To avoid instrument damage set the mainframe ON/STANDBY switch to STANDBY before installing or removing the 11A71

If the green indicator light remains ON, when the STANDBY position is selected, the switch has been internally disabled.

To remove or reinstall plug-in units, use the Principal Power Switch (rear panel) to shut OFF the power. This will prevent damage to either the plug-in or the mainframe.

To once again enable the ON/STANDBY switch, refer the instrument to qualified service personnel.

On page 1-3, for 11A71

CAUTION

To avoid instrument damage set the mainframe ON/STANDBY switch to STANDBY before installing or removing the 11A71

If the green indicator light remains ON, when the STANDBY position is selected, the switch has been internally disabled.

To remove or reinstall plug-in units, use the Principal Power Switch (rear panel) to shut OFF the power. This will prevent damage to either the plug-in or the mainframe.

To once again enable the ON/STANDBY switch, refer the instrument to qualified service personnel.

Product: 11301/11302 Users Reference

Manual Part No.: 070-6106-00

DESCRIPTION

PG. 47

THESE CHANGES ARE EFFECTIVE FOR ALL SERIAL NUMBERS

PLEASE PULL AND REPLACE THE FOLLOWING PAGES IN YOUR MANUAL:

PAGES 1-5
 1-7
 1-13
 2-22
 2-23
 4-1
 4-2
 4-3
 4-4
 4-8
 4-9
 4-37

THESE CHANGES ARE EFFECTIVE FOR ALL SERIAL NUMBERS

TEXT CHANGES

CHANGE TO READ:

PAGE 1-6

Installing Plug-in Units

CAUTION

Before installing or removing plug-in units set the front-panel ON/STANDBY switch to STANDBY. Damage to the instrument may result if you install or remove a plug-in unit with the power ON. If the green indicator light (next to the ON/STANDBY switch) remains lighted, the ON/STANDBY switch has been internally disabled. Therefore, the power will remain ON regardless of the switch setting. Use the Principal Power switch (rear panel) to shut OFF the power before attempting to remove and/or replace plug-ins.

To once again enable the ON/STANDBY switch, refer the instrument to qualified service personnel.

PAGE 2-20

ADD TO BOTTOM OF PAGE:

CAUTION

Do not attempt to remove or reinstall plug-in units if the ON/STANDBY switch is disabled (locked-on). Damage to the plug-ins or the mainframe could result.

If the green light indicator remains lit after the ON/STANDBY switch is moved to STANDBY, the power has been internally locked ON. To remove or replace plug-ins, use the Principal Power Switch (rear panel) to shut OFF the power.

To once again enable the ON/STANDBY switch, refer the instrument to qualified service personnel.

DESCRIPTION

PAGE 2-22

Power-Up Information

FOLLOWING THIRD PARAGRAPH ADD THE FOLLOWING CAUTION:

CAUTION

If the green indicator light remains ON, when the STANDBY position is selected, the switch has been internally disabled.

To remove or reinstall plug-in units, use the Principal Power Switch (rear panel) to shut OFF the power. This will prevent damage to either the plug-in or the mainframe.

To once again enable the ON/STANDBY switch, refer the instrument to qualified service personnel.

Date: 3/31/87

Change Reference: C4/387

Product: 11301/11302 Programmable Oscilloscope

Manual Part No.: 070-6106-00

Product Group 47

These changes are effective for all serial numbers.

Remove the following pages from your manual and replace them with the attached new pages:

Pages 2-79 and 2-80

Pages 4-25 and 4-26

Pages 4-31 and 4-32

Count—offers the choice of which event to count in order to include the Holdoff interval.

One Start—allows for restarting the holdoff count only with the recurrence of the start event (*One Start Off*) or to automatically restart the count at the termination of the count (*One Start On*). For *One Start On*, the start event need only occur once.

After HO—allows for the main sweep to run immediately after holdoff (*Runs After HO*) or to wait for a trigger after holdoff (*Trig'd After HO*).

To define each Holdoff choice in hardware combinations, Table 2-12 supplies a translation.

TABLE 2-12
Holdoff Operation

Holdoff	Description
Time	Time is proportional to Main Time/div. Duration of ≈ 1 to $20X$ Time/div ($2.5 \mu\text{s}$ minimum).
2ns Step	Main Sweep is held off by events where the Start Event=Main Sweep, the Counted Event=2 ns (1.8 increments), and the time base is triggered after the holdoff interval. The holdoff interval spans the Main sweep and sweep reset time.
Countdown	The Main Sweep is held off by events where the Start Event=Main Sweep, the Counted Event=Main Trigger, and the time base runs immediately after the holdoff interval. The holdoff interval spans the Main sweep and sweep reset time.
Events	<p>The caldron where a plethora of choices abound. Here is where the expert will find sanctuary, and the brave novice will be tested.</p> <p>The holdoff interval occurs at the completion of the Main sweep and the sweep reset time. The Start Event=Main Trigger or A Ext; the Counted Event=2 ns (1.8 ns increments), Main Trigger, Delay Trigger, or B External; and the Main sweep can Run After or wait to be Triggered After the holdoff interval. The holdoff interval can be automatically started when the count has expired (One Start=On) or it can wait for another Start event (One Start=Off).</p>

Knob Behavior when using Holdoff

Main Holdoff by Events and Countdown

- Valid coarse settings are linear increments of 100 within a total range of 1 to 2^{29} .
- Valid fine settings are linear increments of 1.

Main Holdoff by 2ns Step

- If Main sweep speed is <200 ns, then coarse increments are 1.8 ns. Otherwise, coarse increments are 1% of current coarse Main Time/div increment.
- Fine increments are 1.8 ns.

Main Holdoff by Time

- Valid coarse settings are 1%.
- Valid fine settings are 0.01%.

Restrictions for Holdoff

- When using *Holdoff=2ns Step* or *Holdoff=Countdown*, the minimum setting is dependent upon the Main Time/div setting. See Table 2-13.

If this restriction is violated, the time bases will no longer operate. To resume normal operation, either

- a. enter a valid holdoff setting from the NUMERIC ENTRY major menu, or
 - b. turn the holdoff knob to a valid setting and then press the TRIGGER RESET button.
- P-P mode and Auto trigger are not recommended for Holdoff by Events or Countdown. The following message appears:

"Use Norm trigger mode for best results"

- When using *Holdoff=Countdown*, creation of holdoff time shorter than the minimum settings shown in Table 2-13 may cause the sweeps to stop. Changing the Main sweep speed or pressing RESET will restart the sweeps. For continued operation, the holdoff time must be set to meet or exceed the minimum time.

Table 4-1 (cont)
Electrical Specification

Characteristics	Performance Requirements
Horizontal Deflection System (cont)	
Delta-Time Delay Using Delayed Sweep with both Delays set $\geq 2\%$ of Full Scale from Minimum Delay	
Accuracy	
Main Time/div ≤ 0.1 sec	
+15° C to +35° C	$\pm(0.3\%$ of time interval plus 0.1% of full scale).
0° C \leq T < 15° or 35° C < T \leq 50° C	$\pm(0.5\%$ of time interval plus 0.1% of full scale).
Main Time/div 0.5 sec and 0.2 sec	
+15° C to +35° C	$\pm(0.8\%$ of time interval plus 0.1% of full scale).
0° C \leq T < 15° or 35° C < T \leq 50° C	$\pm(1.3\%$ of time interval plus 0.1% of full scale).
Resolution	0.005% of full scale.
Range	± 10 times the Main Time/div setting.
Delay Accuracy of two different delay settings $\geq 1\%$ of full scale using one delayed sweep	$\pm(0.3\%$ of delay setting plus 0.6% of full scale).
Delay Jitter	Within 0.005% (one part or less in 20,000) of full scale plus 100 ps.
Delay-Time Range	0 to 10.0 times the Main Time/div setting. The main sweep triggering event is observable on the delayed sweep when delay is set to zero in Runs After Delay mode.

TABLE 4-1 (cont)
Electrical Specification

Characteristics	Performance Requirements
Horizontal Deflection System (cont)	
XY Operation Mainframe Only	
Numeric Position Range	±4.0 times Size/div setting.
Visual Position Range	At least ±3.9 div.
X-Axis Deflection Accuracy for Mainframe Only, CENTER and RIGHT Compartments	Compatible with 11000-Series Plug-in units.
X-Axis Low Frequency Linearity for CENTER & RIGHT Compartments	0.1 div or less compression or expansion of a 2 div, center-screen signal when positioned within the display area.
X-Axis Bandwidth for CENTER and RIGHT Compartments	Dc to 3 MHz. Checked using a standard plug-in with a bandwidth of dc to >100 MHz.
CENTER Compartment Phase Difference between X and Y Axes	≤1° from dc to 1 MHz; ≤3° from 1 MHz to 2 MHz. Checked using a standard plug-in with a bandwidth of dc to >100 MHz.
CENTER Compartment Horiz Accuracy Using Cursors (XY Operation)	Refer to System Specification Section (page 4-42) under the category "Horizontal Deflection Accuracy (XY) of Center Plug-In".

Table 4-1 (cont)
Electrical Specification

Characteristics	Performance Requirements
Triggering, Main and Dly'd (cont)	
Minimum P-P Signal Amplitude Required for Stable Sweep Triggering from A or B External Inputs High Sensitivity Divide by 1 Input Sensitivity Dc Coupled	≤ 20 mV from dc to ≤ 50 MHz; increasing to ≤ 60 mV from > 50 MHz to 300 MHz; and ≤ 150 mV from > 300 MHz to 500 MHz.
Ac Coupled	≤ 20 mV from 50 Hz to ≤ 50 MHz; increasing to ≤ 60 mV from > 50 MHz to 300 MHz; and ≤ 150 mV from > 300 MHz to 500 MHz. Attenuates signal below 50 Hz.
HF Reject Coupled	≤ 28 mV from dc to 30 kHz.
LF Reject Coupled	≤ 28 mV from 80 kHz to ≤ 50 MHz; increasing to ≤ 60 mV from > 50 MHz to 300 MHz; and ≤ 150 mV from > 300 MHz to 500 MHz.
Divide by 5 Input Sensitivity	Multiply above voltages by 5.
Medium Sensitivity	Multiply figures for high sensitivity by 2.
Low Sensitivity	Multiply figures for high sensitivity by 3.
Jitter	< 600 ps Total (peak to peak) with 5 divisions of amplitude at 300 MHz with Time/div set to 5 ns and 10X Mag On.

TABLE 4-1 (cont)
Electrical Specification

Characteristics	Performance Requirements
Triggering, Main and Dly'd (cont)	
Triggering LEVEL Control Range	
LEFT or CENTER Plug-In	±10 times Size/div setting.
A, B External Inputs	
Divide by 1 Sensitivity	±500 mV.
Divide by 5 Sensitivity	±2.5 V.
Trigger LEVEL Readout Accuracy	
LEFT or CENTER Plug-in	Depends on plug-in unit and probe being used. See "System Accuracy Specification."
Single Plug-In Channel Signal Source	See "System Specification."
A or B External Input	For triggering signals with 10 to 90% transition times greater than 10 ns.
Divide by 1 Max Signal ±1 V	Within ±[3.0% of setting plus 4% of p-p signal plus 10 mV plus (0.5 mV times probe attenuation factor)].
Divide by 5 Max Signal ±5 V	Within ±[3.0% of setting plus 4% of p-p signal plus 50 mV plus (0.5 mV times probe attenuation factor)].
Slope Selection	Conforms to trigger-source waveform at input connector or ac power-source waveform.
P-P and Auto Mode Triggering Signal Period	≤50 ms.
Line Trigger Level Range	Sufficient to trigger at positive and negative peaks of ac power source waveform.
Trigger Noise (Mainframe only)	0.05 div rms.
Measurement Accuracy	See "System Specification."

SEND TO: TEKTRONIX, INC.
LAB INSTRUMENTS MARKETING SUPPORT
P.O. BOX 500, DEL STA 39-327
BEAVERTON, OREGON 97077

11000-SERIES OSCILLOSCOPE PROBLEM REPORT

A INSTRUMENT CONFIGURATION:

Instrument	Section	ROM (Version)	ID # (Serial Number)

Option Information

COMPANY NAME: _____
USER: _____
B ADDRESS: _____
CITY: _____ STATE: _____ ZIP: _____
PHONE: _____ EXTENSION: _____

REASON FOR REPORT

- Hardware/Mechanical Problem
- Software/Firmware Problem
- Documentation Problem
- Suggested Enhancement C

SUBMITTED BY: _____ DATE: _____

IS THE PROBLEM REPRODUCIBLE?

- Yes
- No
- Intermittent

D SYSTEM DESCRIPTION: (Hardware, software, firmware and host related to the problem)

E DESCRIPTION OF PROBLEM:

LIST ENCLOSURES:

Instructions For Completing The Problem Report

- I. Please type or print clearly. Use a separate Problem Report (PR) for each problem.
- II. **SECTION A**
Fill in the instrument configuration table, including all plug-in units, modules, and probes installed in the oscilloscope. The information can be found in one of the menus under the UTILITY major menu.
Instrument: Write the instrument name (e.g., 11301, 11401, 11A32, etc.).
Section (Microprocessor Subsystem): If the instrument has more than one section write the section name. For plug-ins, write in which mainframe slot they are located (e.g., left, center, right).
ROM (Version): Write the rom version number for each instrument and section. Instruments with more than one section will have more than one version number.
ID# (Serial Number): Write the serial number for each instrument. At the factory the ID number is programmed to be the instrument's serial number. If this value has been changed, please write the serial number physically attached to the instrument (mainframes: front panel, plug-in units: top rail).
- III. **SECTION B**
Use the complete company mailing address. Include the name and phone number of the person reporting the error. Also, be sure to fill in the name of the person submitting the PR.
- IV. **SECTION C**
Check the reason for the report and whether the problem is reproducible. We cannot fix a problem when we cannot reproduce the problem condition.
- V. **SECTION D**
Give a complete description of the system configuration on which the problem occurred. Include related peripherals, interfaces, options, special switch and/or strap settings and operating system.
- VI. **SECTION E**
Describe the problem completely. Include any information which might help in evaluating the error with the PR. If you have determined a procedure to avoid the error condition, please include this procedure. If this problem prevents you from accomplishing any useful work with the product, please state this fact. Be sure to include with the PR any information (programs, listings, hard copies, etc.) which will help us duplicate your problem.
- VII. **SECTION F**
This section is for use by Tektronix Lab Instruments Marketing Support personnel. **DO NOT WRITE IN THIS SPACE.**
- VIII. Mail **all** copies of the Problem Report to:
TEKTRONIX, INC.
LAB INSTRUMENTS MARKETING SUPPORT
P.O. BOX 500, DEL STA 39-327
BEAVERTON, OREGON 97077

INTERNAL USE ONLY
(DO NOT WRITE BELOW THIS LINE)

DATE RECEIVED
IR #